

Service Manual

Air Conditioner

Indoor Unit Outdoor Unit
CS-RE18JKE-1 CU-RE18JKE-1
CS-RE24JKE-1 CU-RE24JKE-1

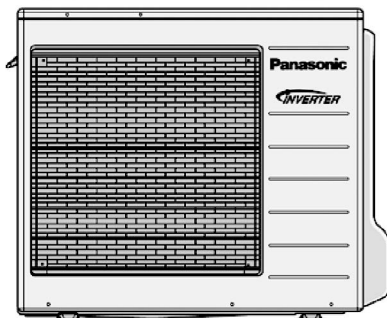
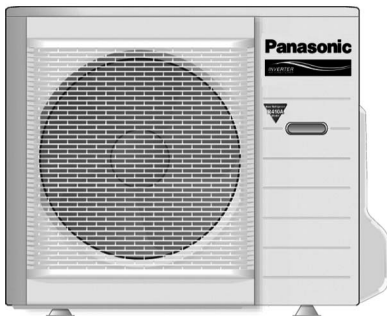

⚠ WARNING

This service information is designed for experienced repair technicians only and is not designed for use by the general public. It does not contain warnings or cautions to advise non-technical individuals of potential dangers in attempting to service a product. Products powered by electricity should be serviced or repaired only by experienced professional technicians. Any attempt to service or repair the product or products dealt with in this service information by anyone else could result in serious injury or death.

⚠ PRECAUTION OF LOW TEMPERATURE

In order to avoid frostbite, be assured of no refrigerant leakage during the installation or repairing of refrigeration circuit.

TABLE OF CONTENTS

	PAGE		PAGE
1 Safety Precautions -----	3	5 Dimensions -----	10
2 Specifications -----	5	5.1. Indoor Unit & Remote Control-----	10
3 Features -----	8	5.2. Outdoor Unit-----	11
4 Location of Controls and Components -----	9	6 Refrigeration Cycle Diagram -----	13
4.1. Indoor Unit-----	9	7 Block Diagram -----	14
4.2. Outdoor Unit-----	9	8 Wiring Connection Diagram -----	15
4.3. Remote Control-----	9	8.1. Indoor Unit-----	15



Panasonic®

© Panasonic HA Air-Conditioning (M) Sdn. Bhd. 2010.
 Unauthorized copying and distribution is a violation of law.

8.2. Outdoor Unit-----	16
9 Electronic Circuit Diagram-----	18
9.1. Indoor Unit -----	18
9.2. Outdoor Unit-----	19
10 Printed Circuit Board -----	21
10.1. Indoor Unit -----	21
10.2. Outdoor Unit-----	23
11 Installation Instruction -----	26
11.1. Select the Best Location -----	26
11.2. Indoor Unit -----	27
11.3. Outdoor Unit-----	31
12 Operation and Control-----	33
12.1. Basic Function -----	33
12.2. Airflow Direction -----	35
12.3. ON Timer Control -----	36
12.4. OFF Timer Control-----	37
12.5. Auto Restart Control-----	37
13 Protection Control-----	38
13.1. Protection Control For All Operations-----	38
13.2. Protection Control For Cooling & Soft Dry Operation-----	40
13.3. Protection Control For Heating Operation -----	41
14 Servicing Mode -----	42
14.1. Auto OFF/ON Button -----	42
14.2. Remote Control Button -----	43
15 Troubleshooting Guide-----	44
15.1. Refrigeration Cycle System -----	44
15.2. Relationship Between The Condition Of The Air Conditioner And Pressure And Electric Current-----	45
15.3. Breakdown Self Diagnosis Function -----	46
15.4. Error Codes Table-----	47
15.5. Self-diagnosis Method -----	48
16 Disassembly and Assembly Instructions-----	72
16.1. Indoor Electronic Controllers, Cross Flow Fan and Indoor Fan Motor Removal Procedures -----	72
16.2. Outdoor Electronic Controller Removal Procedure (RE18JK) -----	77
17 Technical Data-----	78
17.1. Operation Characteristics -----	78
17.2. Sensible Capacity Chart-----	86
18 Exploded View and Replacement Parts List -----	87
18.1. Indoor Unit -----	87
18.2. CU-RE18JKE-1 -----	90
18.3. CU-RE24JKE-1 -----	93

1 Safety Precautions







- Read the following “SAFETY PRECAUTIONS” carefully before perform any servicing.
- Electrical work must be installed or serviced by a licensed electrician. Be sure to use the correct rating of the power plug and main circuit for the model installed.
- The caution items stated here must be followed because these important contents are related to safety. The meaning of each indication used is as below. Incorrect installation or servicing due to ignoring of the instruction will cause harm or damage, and the seriousness is classified by the following indications.

 WARNING	This indication shows the possibility of causing death or serious injury.
 CAUTION	This indication shows the possibility of causing injury or damage to properties.

- The items to be followed are classified by the symbols:

	This symbol denotes item that is PROHIBITED from doing.
---	---

- Carry out test run to confirm that no abnormality occurs after the servicing. Then, explain to user the operation, care and maintenance as stated in instructions. Please remind the customer to keep the operating instructions for future reference.

 WARNING	
1. Do not modify the machine, part, material during repairing service.	
2. If wiring unit is supplied as repairing part, do not repair or connect the wire even only partial wire break. Exchange the whole wiring unit.	
3. Do not wrench the fasten terminal. Pull it out or insert it straightly.	
4. Engage dealer or specialist for installation and servicing. If installation of servicing done by the user is defective, it will cause water leakage, electrical shock or fire.	
5. Install according to this installation instructions strictly. If installation is defective, it will cause water leakage, electrical shock or fire.	
6. Use the attached accessories parts and specified parts for installation and servicing. Otherwise, it will cause the set to fall, water leakage, fire or electrical shock.	
7. Install at a strong and firm location which is able to withstand the set's weight. If the strength is not enough or installation is not properly done, the set will drop and cause injury.	
8. For electrical work, follow the local national wiring standard, regulation and the installation instruction. An independent circuit and single outlet must be used. If electrical circuit capacity is not enough or defect found in electrical work, it will cause electrical shock or fire.	
9. This equipment is strongly recommended to install with Earth Leakage Circuit Breaker (ELCB) or Residual Current Device (RCD). Otherwise, it may cause electrical shock and fire in case equipment breakdown or insulation breakdown.	
10. Do not use joint cable for indoor / outdoor connection cable. Use the specified indoor / outdoor connection cable, refer to installation instruction CONNECT THE CABLE TO THE INDOOR UNIT and connect tightly for indoor / outdoor connection. Clamp the cable so that no external force will be acted on the terminal. If connecting or fixing is not perfect, it will cause heat up or fire at the connection.	
11. Wire routing must be properly arranged so that control board cover is fixed properly. If control board cover is not fixed perfectly, it will cause heat-up or fire at the connection point of terminal, fire or electrical shock.	
12. When install or relocate air conditioner, do not let any substance other than the specified refrigerant, eg. air etc. mix into refrigeration cycle (piping). (Mixing of air etc. will cause abnormal high pressure in refrigeration cycle and result in explosion, injury etc.).	
13. Do not install outdoor unit near handrail of veranda. When installing air-conditioner unit at veranda of high rise building, child may climb up to outdoor unit and cross over the handrail and causing accident.	
14. This equipment must be properly earthed. Earth line must not be connected to gas pipe, water pipe, earth of lightning rod and telephone. Otherwise, it may cause electric shock in case equipment breakdown or insulation breakdown.	
15. Keep away from small children, the thin film may cling to nose and mouth and prevent breathing.	
16. Do not use unspecified cord, modified cord, joint cord or extension cord for power supply cord. Do not share the single outlet with other electrical appliances. Poor contact, poor insulation or over current will cause electrical shock or fire.	
17. Tighten the flare nut with torque wrench according to specified method. If the flare nut is over-tightened, after a long period, the flare may break and cause refrigerant gas leakage.	
18. In case of using existing (R22) pipes during installation of R410 models, must carry out pump down properly to collect back the refrigerant and oil before installation new unit. Thickness of copper pipes used with R410A must be more than 0.6mm. Never use copper pipes thinner than 0.6mm. It is desirable that the amount of residual oil is less than 40 mg/10m.	

 **WARNING**

19. During installation, install the refrigerant piping properly before run the compressor. (Operation of compressor without fixing refrigeration piping and valves at opened condition will cause suck-in of air, abnormal high pressure in refrigeration cycle and result in explosion, injury etc.)

This symbol denotes item that is PROHIBITED from doing.

20. During pump down operation, stop the compressor before remove the refrigerant piping. (Removal of refrigeration piping while compressor is operating and valves are opened condition will cause suck-in of air, abnormal high pressure in refrigeration cycle and result in explosion, injury etc.).

21. After completion of the installation servicing, confirm there is no leakage of refrigerant gas. It may generate toxic gas when the refrigerant contacts with fire.

22. Ventilate if there is refrigerant gas leakage during operation. It may cause toxic gas when the refrigerant contacts with fire.

23. Do not insert your fingers or other objects into the unit, high speed rotating fan may cause injury.



24. Must not use other parts except original parts describe in catalog and manual.

 **CAUTION**

1. Do not install the unit at place where leakage of flammable gas may occur. In case gas leaks and accumulates at surrounding of the unit, it may cause fire.



2. Carry out drainage piping as mentioned in installation instructions. If drainage is not perfect, water may enter the room and damage the furniture.

3. Tighten the flare nut with torque wrench according to specified method. If the flare nut is over-tightened, after a long period, the flare may break and cause refrigerant gas leakage.

4. Do not touch outdoor unit air inlet and aluminium fin. It may cause injury.



5. Select an installation location which is easy for maintenance.

6. Pb free solder has a higher melting point than standard solder; typically the melting point is 50°F - 70°F (30°C - 40°C) higher. Please use a high temperature solder iron. In case of the soldering iron with temperature control, please set it to 700 ± 20°F (370 ± 10°C). Pb free solder will tend to splash when heated too high (about 1100°F / 600°C).

7. Power supply connection to the conditioner. Connect the power supply cord of the air conditioner to the mains using one of the following methods.

Power supply point shall be the place where there is ease for access for the power disconnection in case of emergency. In some countries, permanent connection of this room air conditioner to the power supply is prohibited.

1. Power supply connection to the receptacle using a power plug. Use an approved 15/16A (3/4 ~ 1.75HP), 16A (2.0HP), 20A (2.5HP) or 25A (3.0HP) power plug with earth pin for the connection to the socket.

2. Power supply connection to a circuit breaker for the permanent connection. Use an approved 16A (3/4 ~ 2.0HP), 20A (2.5HP) or 25A (3.0HP) circuit breaker for the permanent connection. It must be a double pole switch with a minimum 3.0 mm contact gap.

8. Do not release refrigerant during piping work for installation, servicing, reinstallation and during repairing a refrigeration parts. Take care of the liquid refrigerant, it may cause frostbite.



9. Installation or servicing work. It may need two people to carry out the installation or servicing work.

10. Do not install this appliance in a laundry room or other location where water may drip from the ceiling, etc.



11. Do not sit or step on the unit, you may fall down accidentally.



12. Do not touch the sharp aluminium fin, sharp parts may cause injury.



2 Specifications

MODEL			INDOOR	CS-RE18JKE-1			CS-RE24JKE-1			
			OUTDOOR	CU-RE18JKE-1			CU-RE24JKE-1			
Performance Test Condition			EUROVENT			EUROVENT				
Power Supply			Phase, Hz	Single, 50			Single, 50			
			V	230			230			
			Min.	Mid.	Max.	Min.	Mid.	Max.		
C o l l i n g	Capacity		kW	0.90	5.00	6.00	0.90	6.80	8.10	
			BTU/h	3070	17100	20500	3070	23200	27600	
			Kcal/h	770	4300	5160	770	5850	6970	
	Running Current		A	—	6.7	—	—	9.7	—	
	Input Power		W	215	1.47k	2.03k	350	2.12k	2.70k	
	Annual Consumption		kWh	—	735	—	—	1060	—	
	EER		W/W	4.19	3.40	2.96	2.57	3.21	3.00	
			Kcal/hW	3.58	2.93	2.54	2.20	2.76	2.58	
	Power Factor		%	—	95	—	—	95	—	
	Indoor Noise (H / L / QLo)		dB-A	44 / 37 / -			47 / 38 / -			
Power Level dB			60			63				
Outdoor Noise (H / L)		dB-A	47			52				
		Power Level dB	61			66				
H e a t i n g	Capacity		kW	0.90	5.80	8.00	0.90	8.60	9.90	
			BTU/h	3070	19800	27300	3070	29300	33800	
			Kcal/h	770	4990	6880	770	7400	8510	
	Running Current		A	—	7.0	—	—	12.1	—	
	Input Power		W	245	1.54k	2.60k	360	2.66k	3.20k	
	COP		W/W	3.67	3.77	3.08	2.50	3.23	3.09	
			Kcal/hW	3.14	3.24	2.65	2.14	2.78	2.66	
	Power Factor		%	—	96	—	—	96	—	
	Indoor Noise (H / L / QLo)		dB-A	44 / 37 / -			47 / 38 / -			
			Power Level dB	60			63			
Outdoor Noise (H / L)		dB-A	47			52				
		Power Level dB	61			66				
Low Temp.: Capacity (kW) / I.Power (W) / COP			5.80 / 2.35k / 2.47			7.17 / 2.83k / 2.53				
Extr Low Temp.: Capacity (kW) / I.Power (W) / COP			4.98 / 2.41k / 2.07			6.13 / 2.86k / 2.14				
Max Current (A) / Max Input Power (W)			11.7 / 2.60k			14.6 / 3.20k				
Starting Current (A)			7.0			12.1				
Compressor		Type	Hermetic Motor			Hermetic Motor				
		Motor Type	Brushless (4-poles)			Brushless (4-poles)				
		Output Power	W	900			1.7k			
I N D O O R F A N	Type		Cross-Flow Fan			Cross-Flow Fan				
	Material		ASG30K1			ASG30K1				
	Motor Type		DC Motor			DC Motor				
	Input Power		W	94.8			85.1			
	Output Power		W	40			40			
	Speed	QLo	Cool	rpm	960			950		
			Heat	rpm	1040			1040		
		Lo	Cool	rpm	1040			1050		
			Heat	rpm	1120			1140		
		Me	Cool	rpm	1160			1230		
			Heat	rpm	1240			1310		
		Hi	Cool	rpm	1280			1410		
			Heat	rpm	1360			1480		
SHi		Cool	rpm	1390			1480			
		Heat	rpm	1430			1520			

MODEL				INDOOR	CS-RE18JKE-1	CS-RE24JKE-1		
				OUTDOOR	CU-RE18JKE-1	CU-RE24JKE-1		
O U T D O O R F A N	Type				Propeller Fan	Propeller Fan		
	Material				PP	PP		
	Motor Type				PWM (8-poles)	Induction (6-poles)		
	Input Power			W	74.8	178.02		
	Output Power			W	40	80		
	Speed	Hi	Cool	rpm	660	690		
		Heat	rpm	680	630			
Moisture Removal				L/h (Pt/h)	2.8 (5.9)	3.9 (8.2)		
Indoor Airflow		QLo	Cool	m ³ /min (ft ³ /min)	12.00 (424)	12.40 (438)		
			Heat	m ³ /min (ft ³ /min)	13.20 (466)	13.70 (485)		
		Lo	Cool	m ³ /min (ft ³ /min)	13.20 (466)	13.70 (484)		
			Heat	m ³ /min (ft ³ /min)	14.30 (505)	15.0 (531)		
		Me	Cool	m ³ /min (ft ³ /min)	14.90 (526)	16.10 (567)		
			Heat	m ³ /min (ft ³ /min)	16.00 (565)	17.30 (611)		
		Hi	Cool	m ³ /min (ft ³ /min)	16.30 (575)	18.4 (650)		
			Heat	m ³ /min (ft ³ /min)	17.90 (630)	19.5 (690)		
		SHi	Cool	m ³ /min (ft ³ /min)	18.10 (639)	19.30 (682)		
			Heat	m ³ /min (ft ³ /min)	18.50 (653)	20.0 (709)		
		Outdoor Airflow		Hi	Cool	m ³ /min (ft ³ /min)	40.0 (1410)	50.2 (1770)
					Heat	m ³ /min (ft ³ /min)	38.6 (1360)	50.2 (1770)
Refrigeration Cycle		Control Device			Expansion Valve	Capillary Tube		
		Refrigerant Oil		cm ³	RB68A or Freol Alpha 68M (400)	FV50S (800)		
		Refrigerant Type		g (oz)	R410A, 1.15k (40.6)	R410A, 1.70k (60.0)		
Dimension		Height (I/D / O/D)		mm (inch)	290 (11-7/16) / 750 (29-17/32)	290 (11-7/16) / 795 (31-5/16)		
		Width (I/D / O/D)		mm (inch)	1070 (42-5/32) / 875 (34-15/32)	1070 (42-5/32) / 875 (34-15/32)		
		Depth (I/D / O/D)		mm (inch)	235 (9-9/32) / 345 (13-19/32)	235 (9-9/32) / 320 (12-5/8)		
Weight		Net (I/D / O/D)		kg (lb)	12 (26) / 48 (106)	12 (26) / 65 (143)		
P I P E I N G	Pipe Diameter (Liquid / Gas)			mm (inch)	6.35 (1/4) / 12.70 (1/2)	6.35 (1/4) / 15.88 (5/8)		
	Standard Length			m (ft)	5.0 (16.4)	5.0 (16.4)		
	Length Range (min - max)			m (ft)	3 (9.8) ~ 20 (65.6)	3 (9.8) ~ 30 (98.4)		
	I/D & O/D Height Different			m (ft)	15.0 (49.2)	20 (65.6)		
	Additional Gas Amount			g/m (oz/ft)	20 (0.2)	30 (0.3)		
	Length for Additional Gas			m (ft)	10.0 (32.8)	10 (32.8)		
Drain Hose		Inner Diameter		mm	16	16		
		Length		mm	650	650		
Indoor Heat Exchanger		Fin Material			Aluminium (Pre Coat)	Aluminium (Pre Coat)		
		Fin Type			Slit Fin	Slit Fin		
		Row × Stage × FPI			2 × 15 × 19	2 × 15 × 21		
		Size (W × H × L)		mm	810 × 315 × 25.4	810 × 315 × 25.4		
Outdoor Heat Exchanger		Fin Material			Aluminium (Pre Coat)	Aluminium (Pre Coat)		
		Fin Type			Corrugated Fin	Corrugated Fin		
		Row × Stage × FPI			2 × 34 × 17	2 × 30 × 19		
		Size (W × H × L)		mm	36.4 × 714 × 794.6 823.3	38.1 × 762 × 895.8 865.8		
Air Filter		Material			Polypropylene	Polypropylene		
		Type			One-Touch	One-Touch		
Power Supply					Outdoor Power Supply	Outdoor Power Supply		
Power Supply Cord				A	Nil	Nil		

MODEL		INDOOR	CS-RE18JKE-1		CS-RE24JKE-1	
		OUTDOOR	CU-RE18JKE-1		CU-RE24JKE-1	
Thermostat			Electronic Control		Electronic Control	
Protection Device			Electronic Control		Electronic Control	
			Dry Bulb	Wet Bulb	Dry Bulb	Wet Bulb
Indoor Operation Range	Cooling	Maximum	32	23	32	23
		Minimum	16	11	16	11
	Heating	Maximum	30	—	30	—
		Minimum	16	—	16	—
Outdoor Operation Range	Cooling	Maximum	43	26	43	26
		Minimum	5	4	16	11
	Heating	Maximum	24	18	24	18
		Minimum	-5	-6	-5	-6

1. Cooling capacities are based on indoor temperature of 27°C Dry Bulb (80.6°F Dry Bulb), 19.0°C Wet Bulb (66.2°F Wet Bulb) and outdoor air temperature of 35°C Dry Bulb (95°F Dry Bulb), 24°C Wet Bulb (75.2°F Wet Bulb)
2. Heating capacities are based on indoor temperature of 20°C Dry Bulb (68°F Dry Bulb) and outdoor air temperature of 7°C Dry Bulb (44.6°F Dry Bulb), 6°C Wet Bulb (42.8°F Wet Bulb)
3. Heating low temperature capacity, Input Power and COP measured at 230 V, indoor temperature of 20°C, outdoor 2/1°C.
4. Heating extreme low temperature capacity, Input Power and COP measured at 230 V, indoor temperature of 20°C, outdoor -7/-8°C.
5. Specifications are subjected to change without prior notice for further improvement.

3 Features

- **Inverter Technology**
 - Wider output range
 - Energy saving
 - Quick Cooling
 - More precise temperature control
- **Environment Protection**
 - Non-ozone depletion substances refrigerant (R410A)
- **Long Installation Piping**
 - CS/CU-RE18JKE-1, long piping up to 20 meter
 - CS/CU-RE24JKE-1, long piping up to 30 meter
- **Easy to use remote control**
- **Quality Improvement**
 - Random auto restart after power failure for safety restart operation
 - Gas leakage protection
 - Prevent compressor reverse cycle
 - Inner protector to protect compressor
 - Noise prevention during soft dry operation
- **Serviceability Improvement**
 - Breakdown Self Diagnosis function

4 Location of Controls and Components

4.1. Indoor Unit

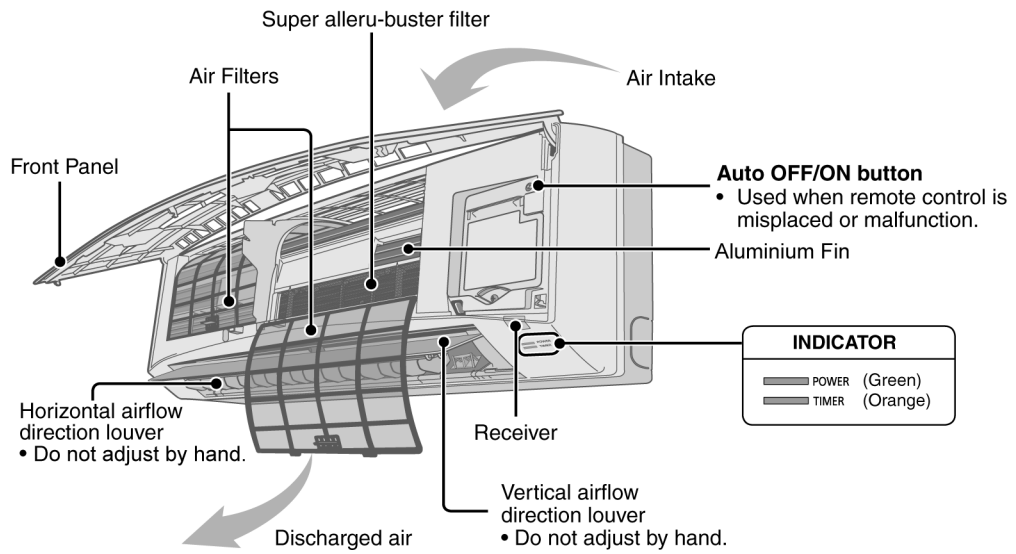

4.2. Outdoor Unit

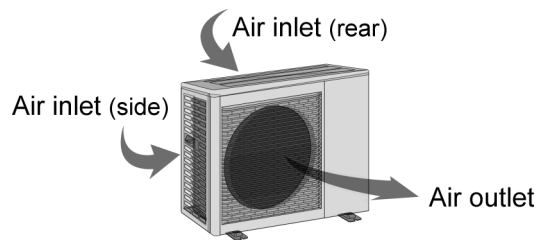

4.3. Remote Control

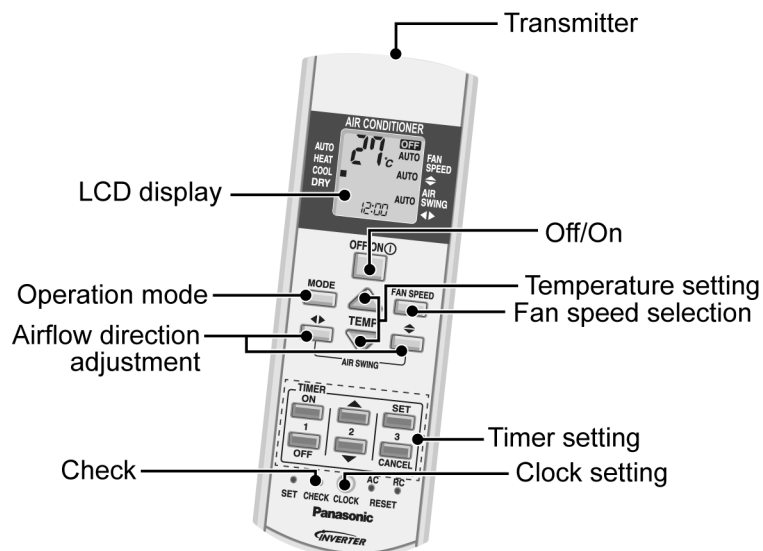

5 Dimensions

5.1. Indoor Unit & Remote Control

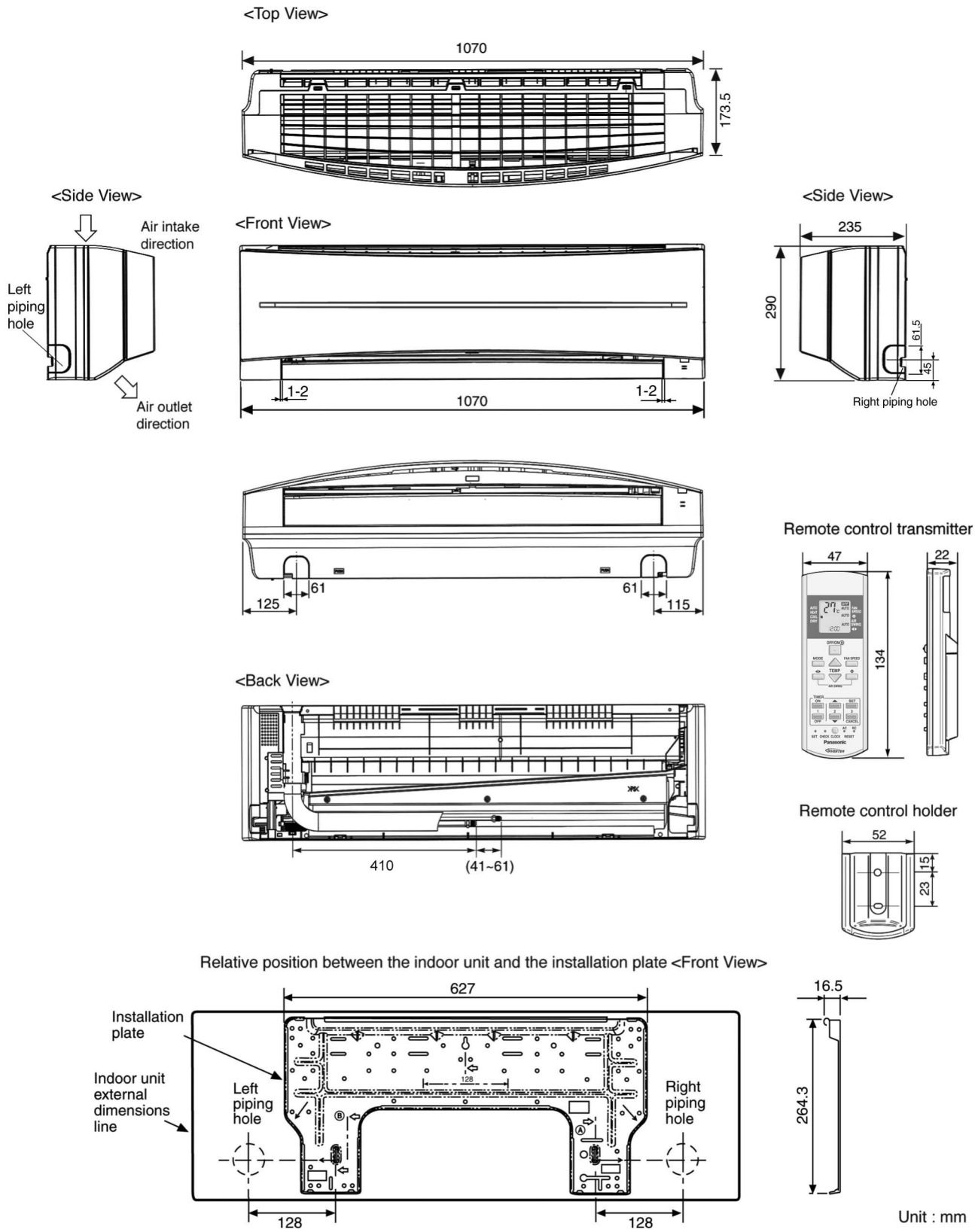

5.2. Outdoor Unit

5.2.1. CU-RE18JKE-1

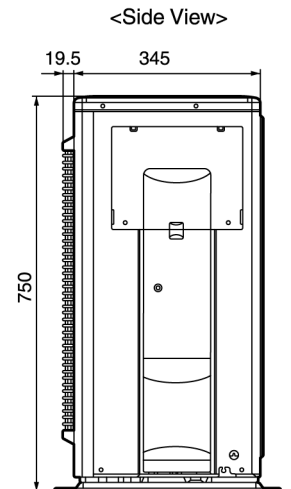
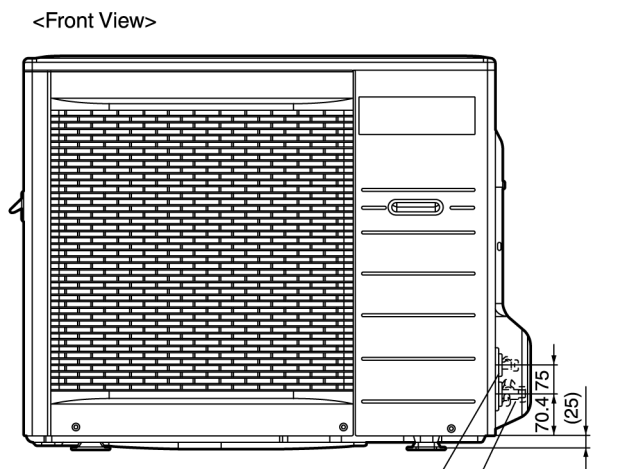
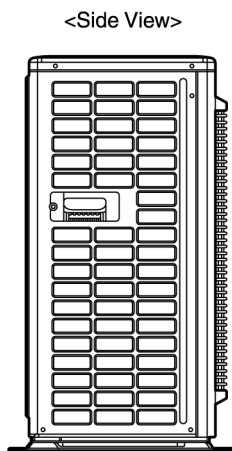
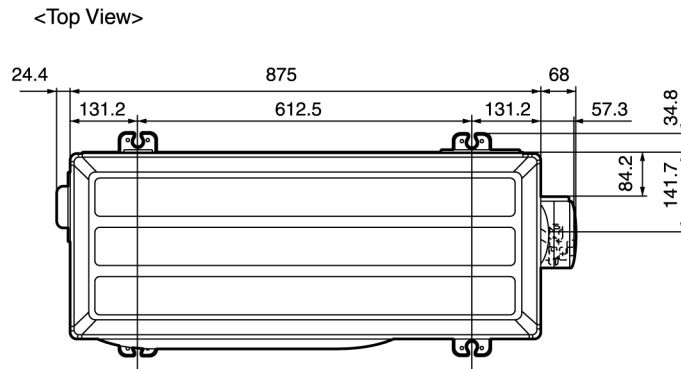
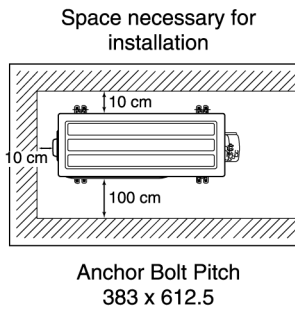

3-way valve at Gas side
(Low Pressure)

2-way valve at Liquid side
(High Pressure)

Unit: mm

5.2.2. CU-RE24JKE-1

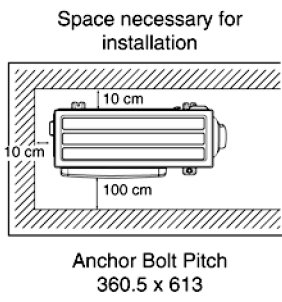

<Top View>

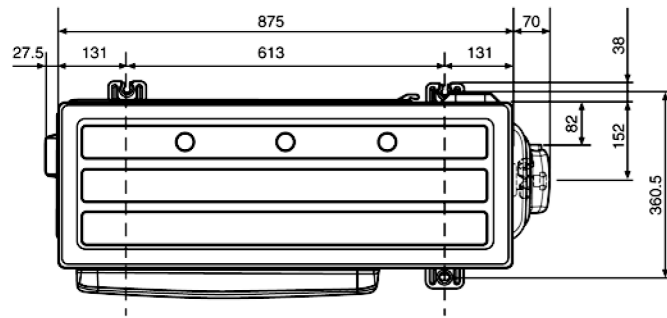

<Side View>

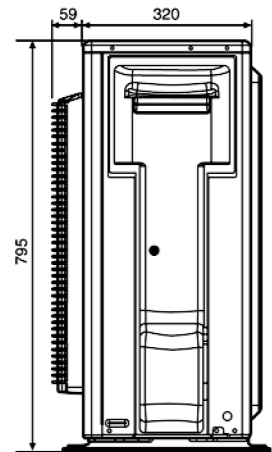

<Side View>

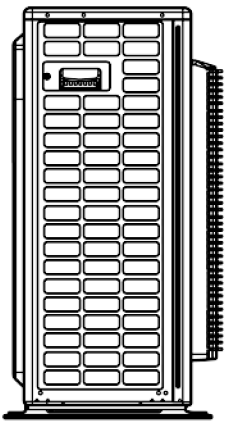

<Front View>

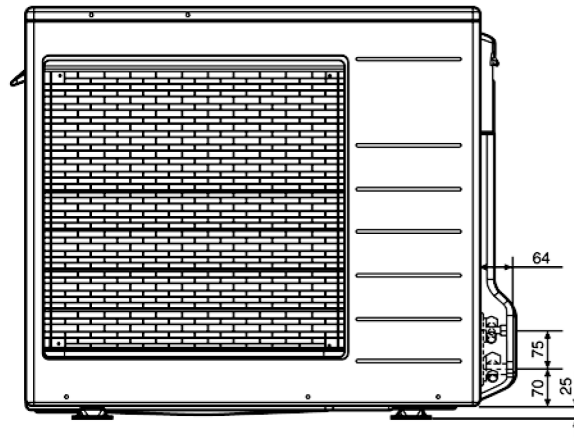

Unit : mm

6 Refrigeration Cycle Diagram

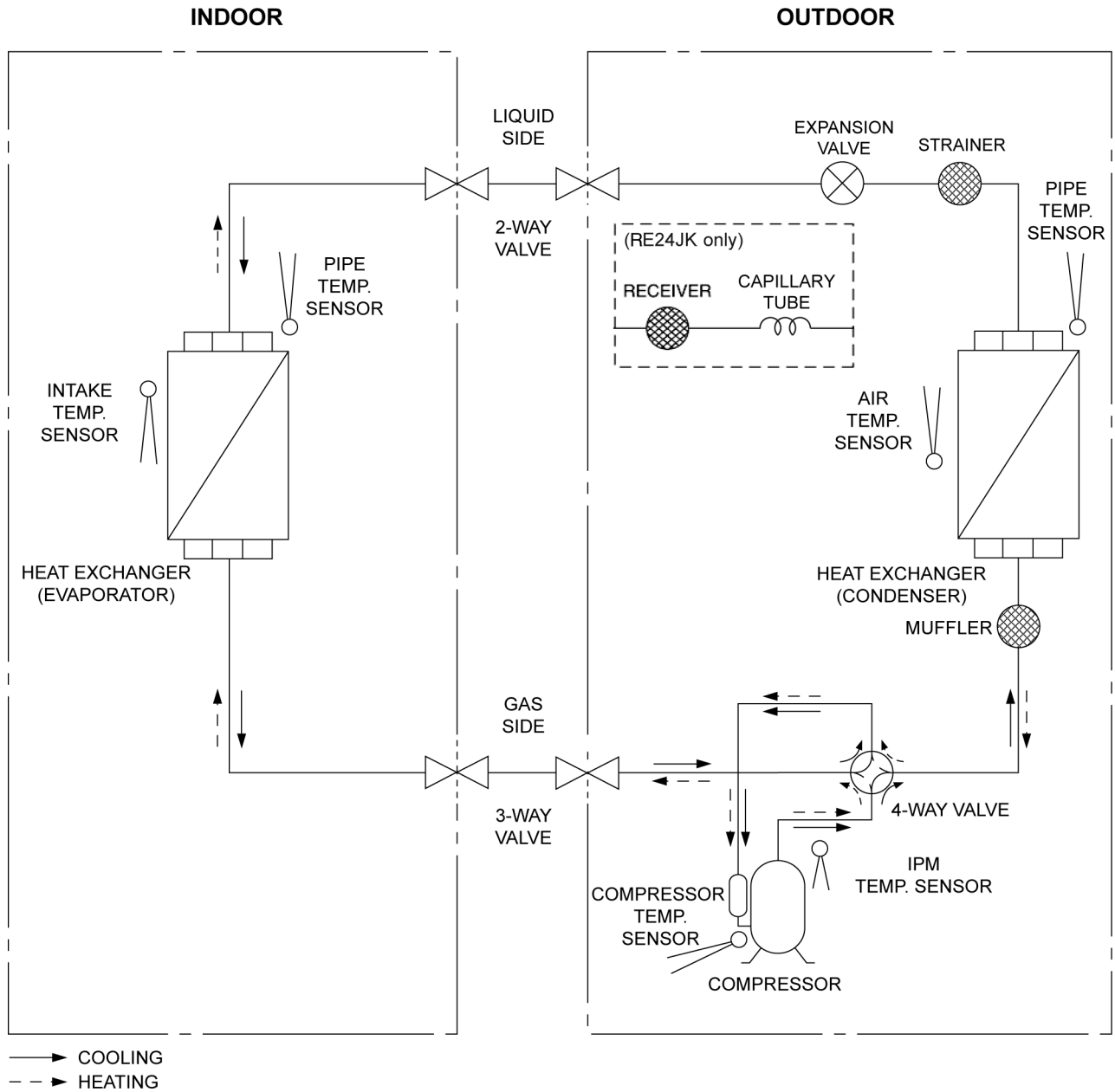

7 Block Diagram

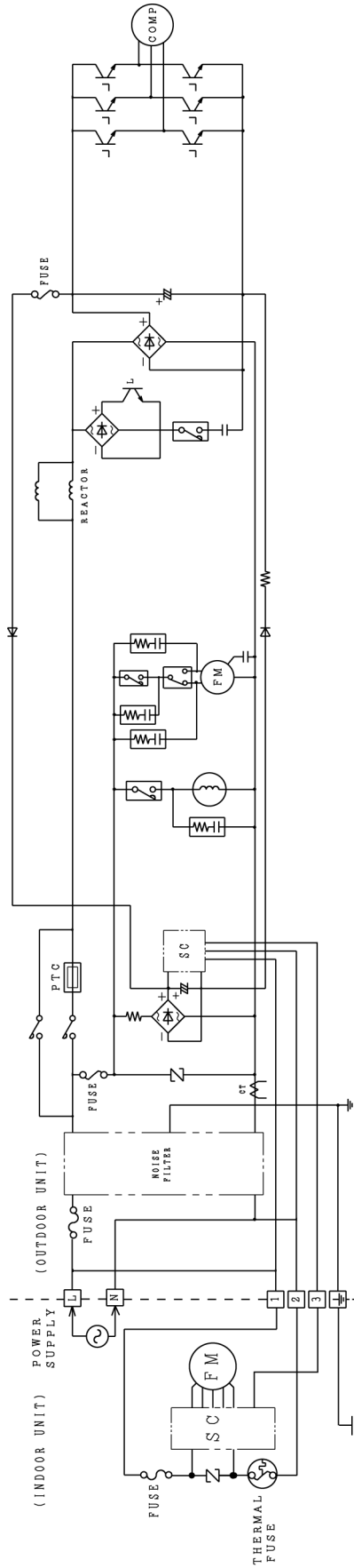

8 Wiring Connection Diagram

8.1. Indoor Unit

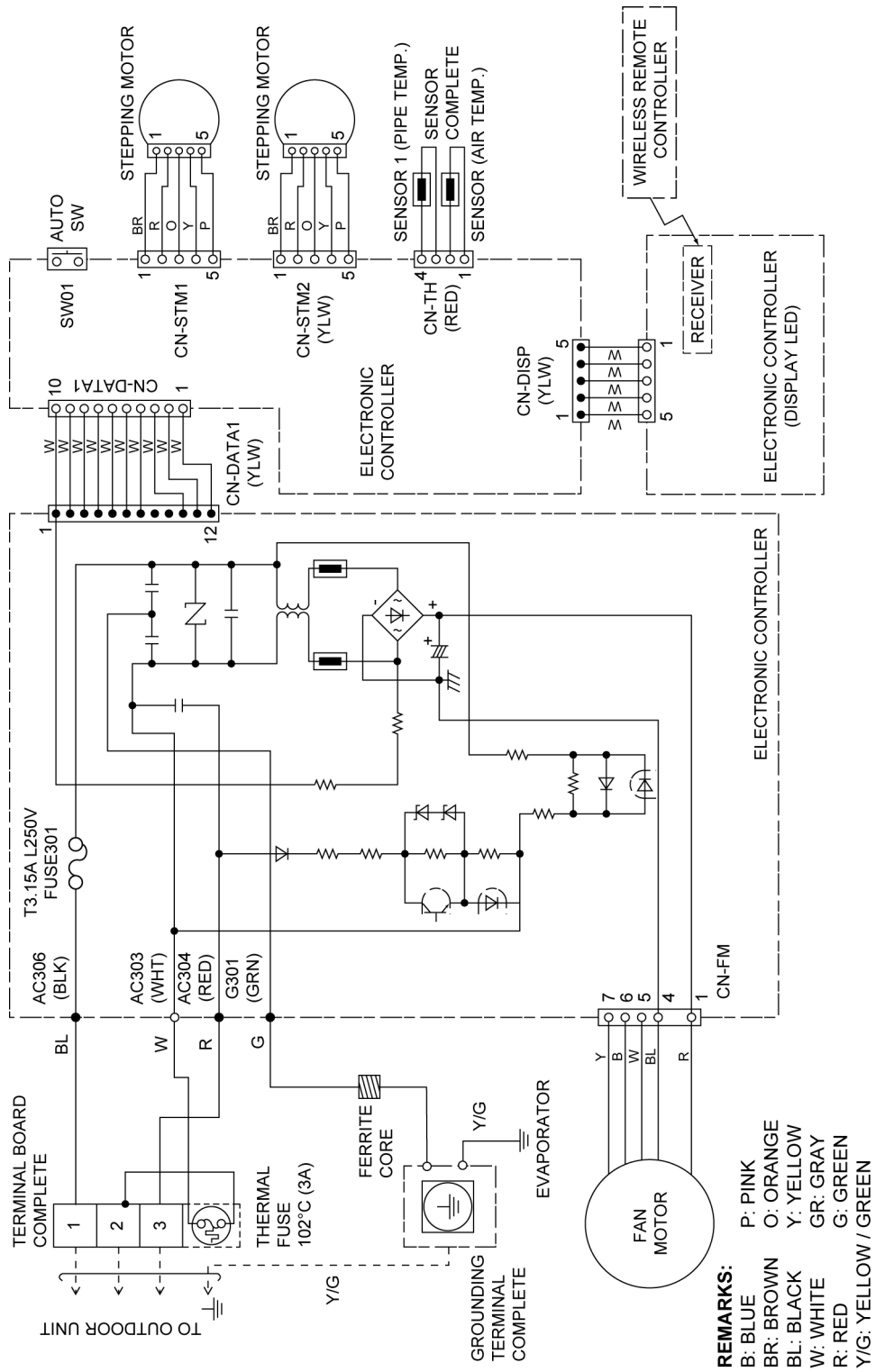

8.2. Outdoor Unit

8.2.1. CU-RE18JKE-1

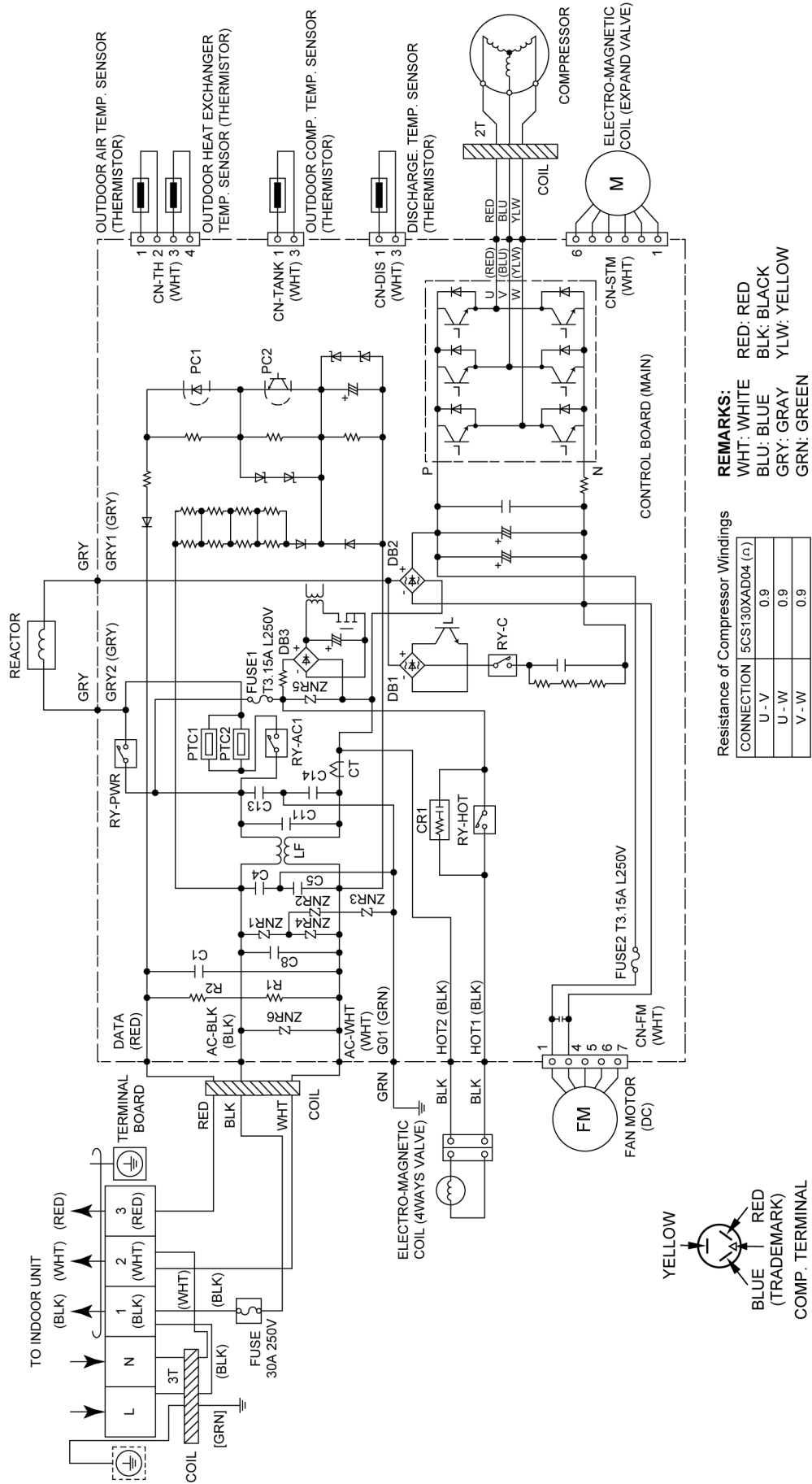

8.2.2. CU-RE24JKE-1

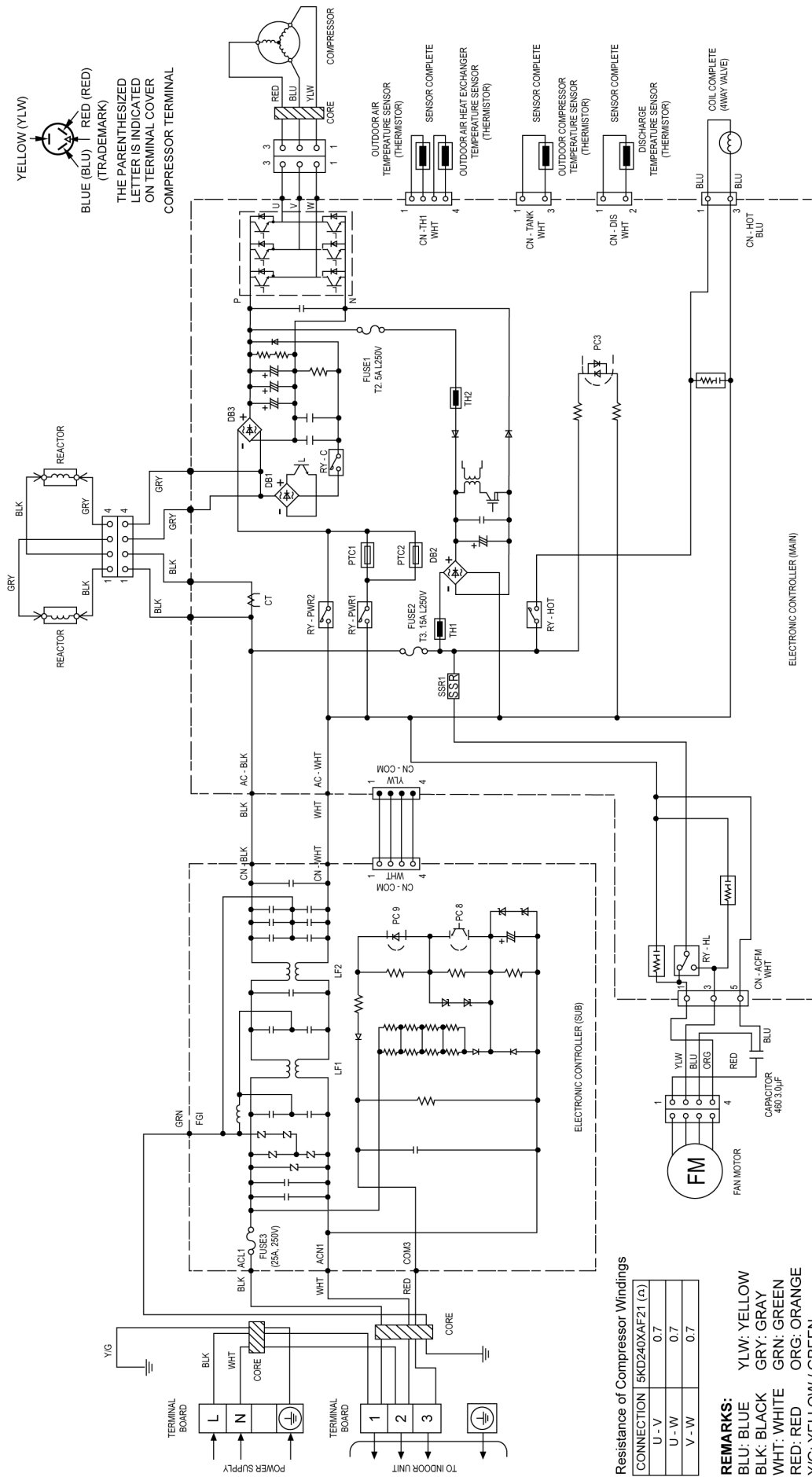

9 Electronic Circuit Diagram

9.1. Indoor Unit

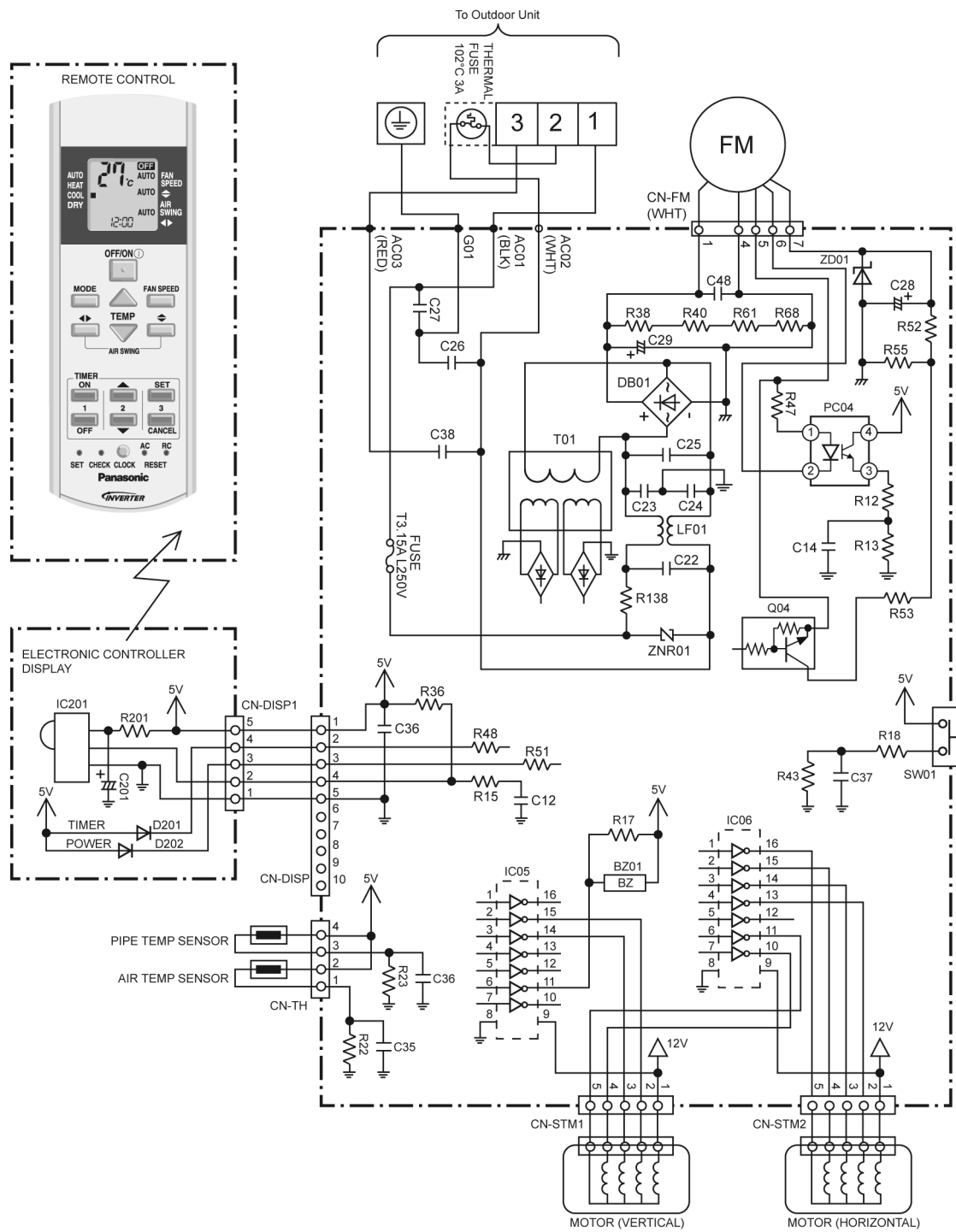

9.2. Outdoor Unit

9.2.1. CU-RE18JKE-1

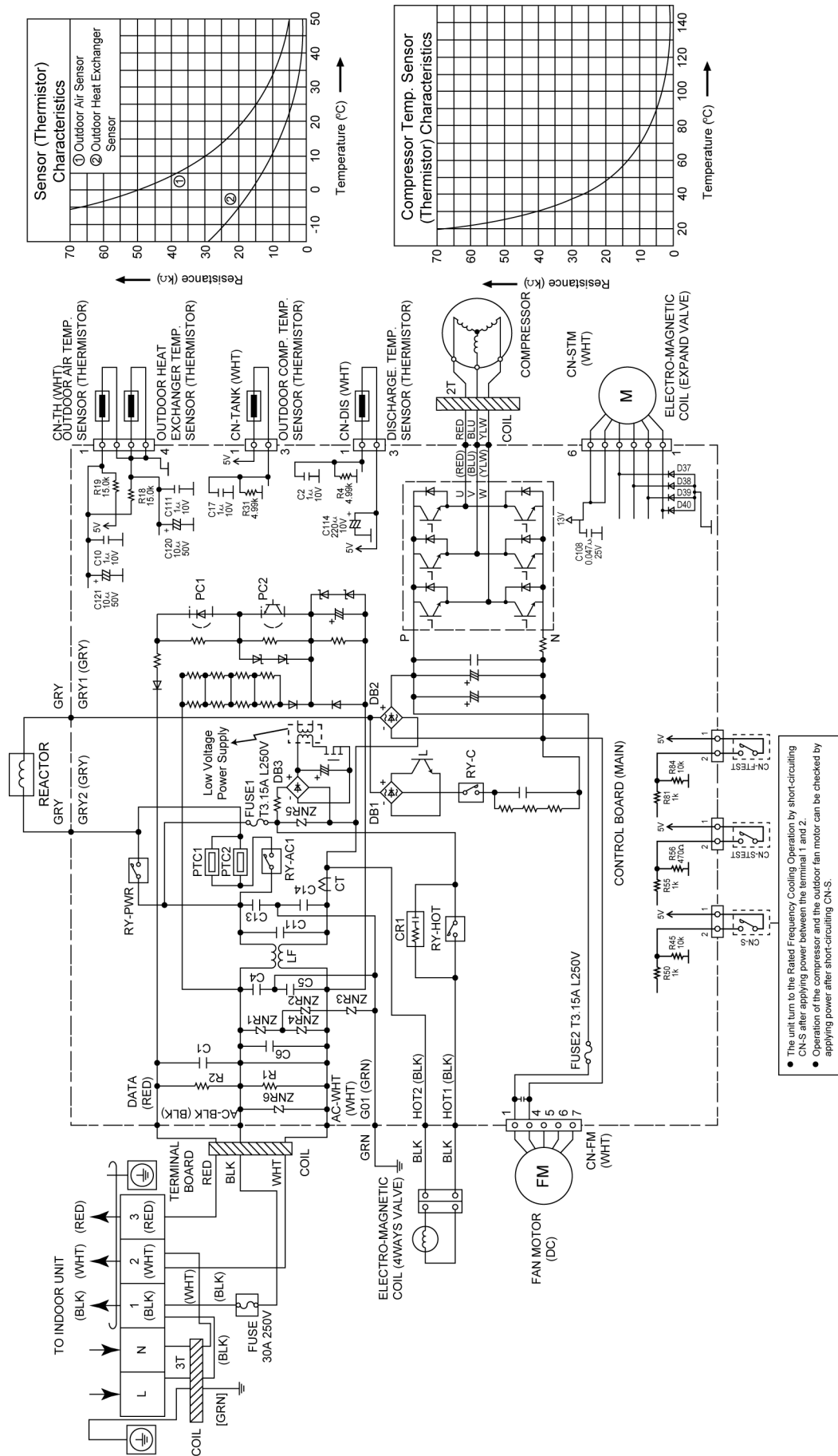

9.2.2. CU-RE24JKE-1

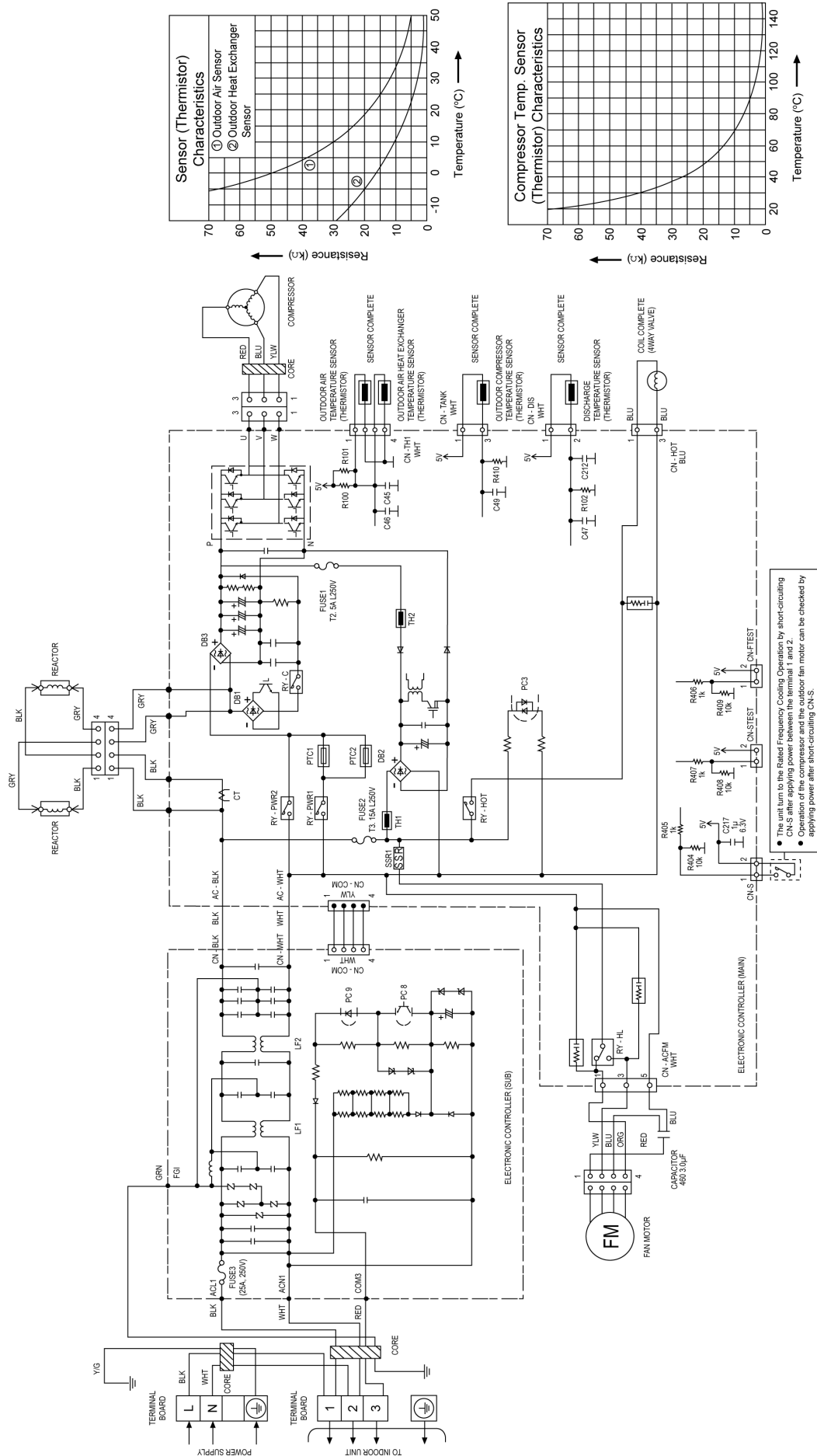

10 Printed Circuit Board

10.1. Indoor Unit

10.1.1. Main Printed Circuit Board

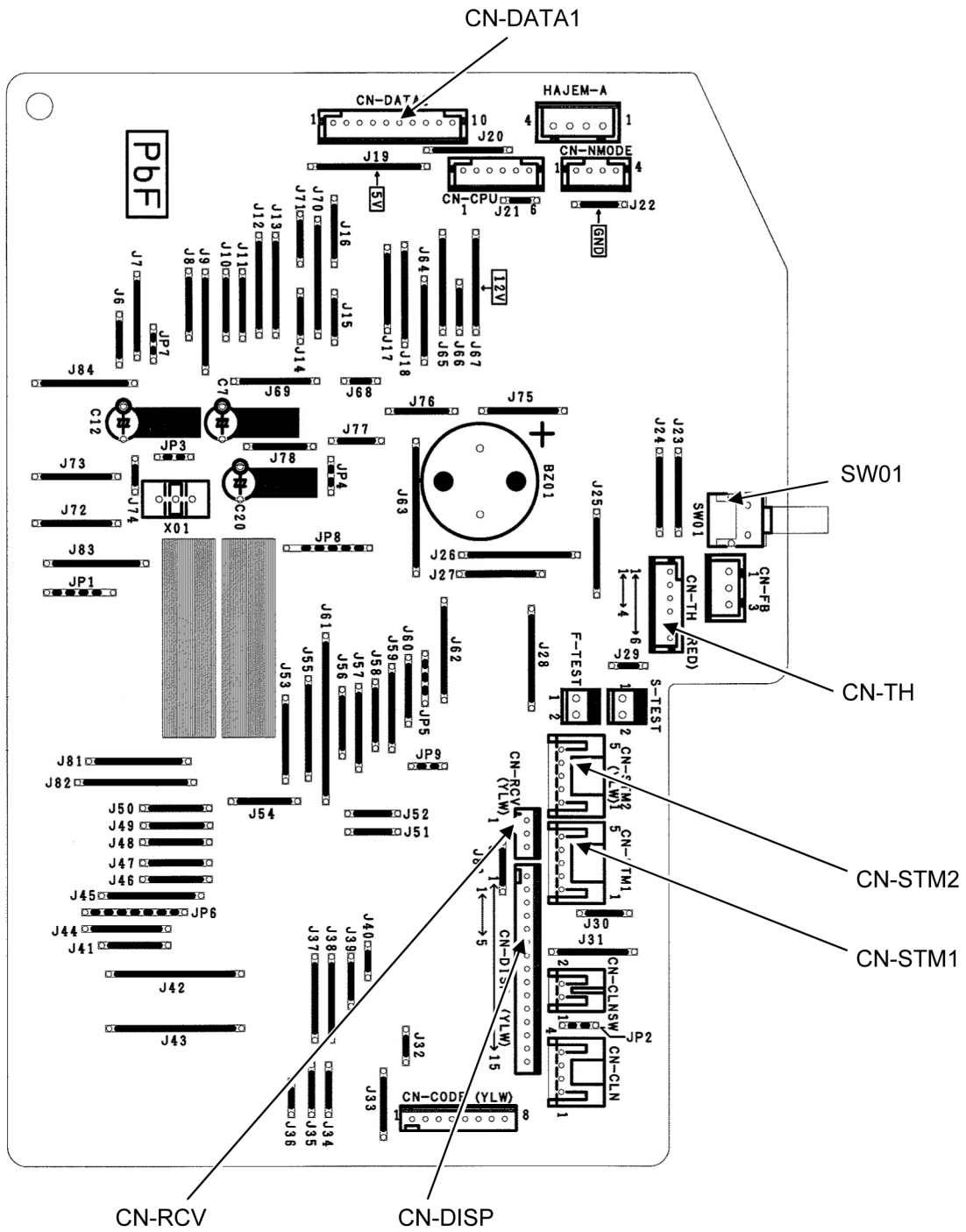

10.1.2. Power Printed Circuit Board

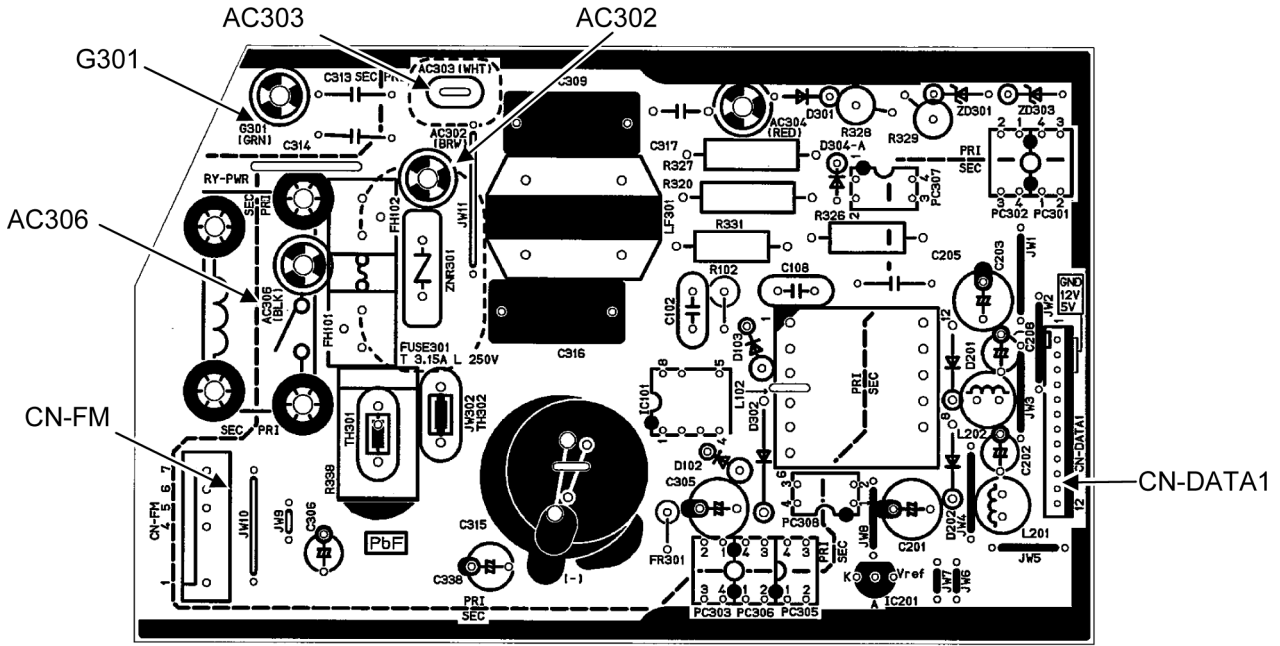

10.1.3. Indicator Printed Circuit Board

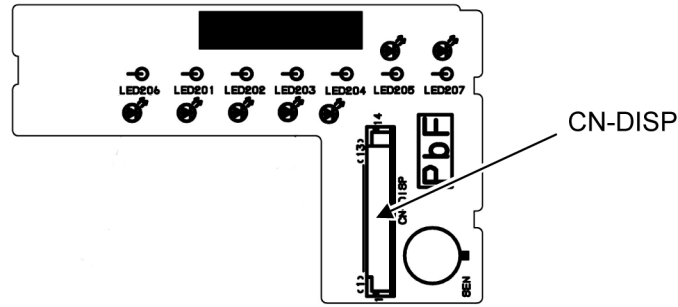

10.2. Outdoor Unit

10.2.1. Main Printed Circuit Board

10.2.1.1. CU-RE18JKE-1

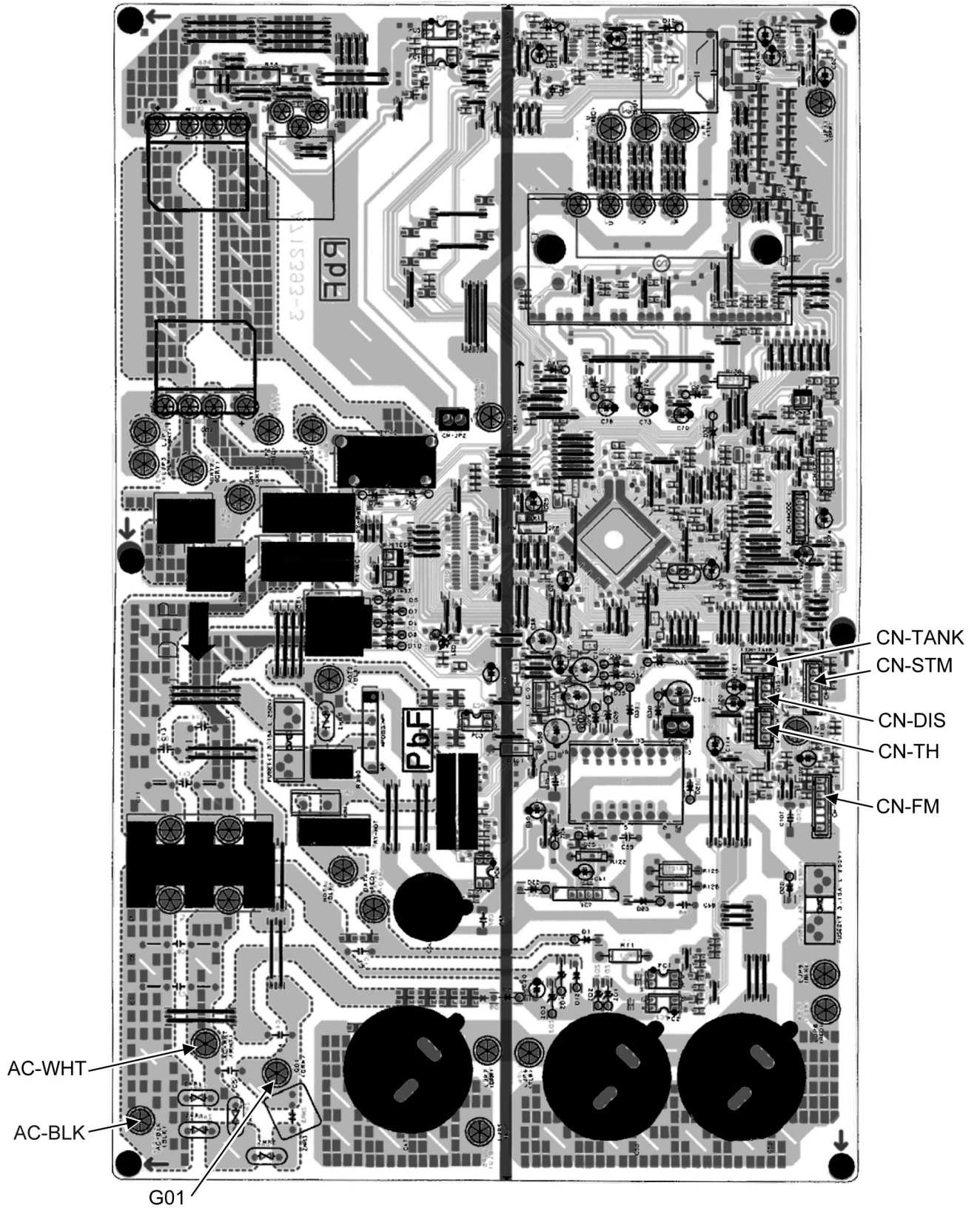

10.2.2. Main Printed Circuit Board

10.2.2.1. CU-RE24JKE-1

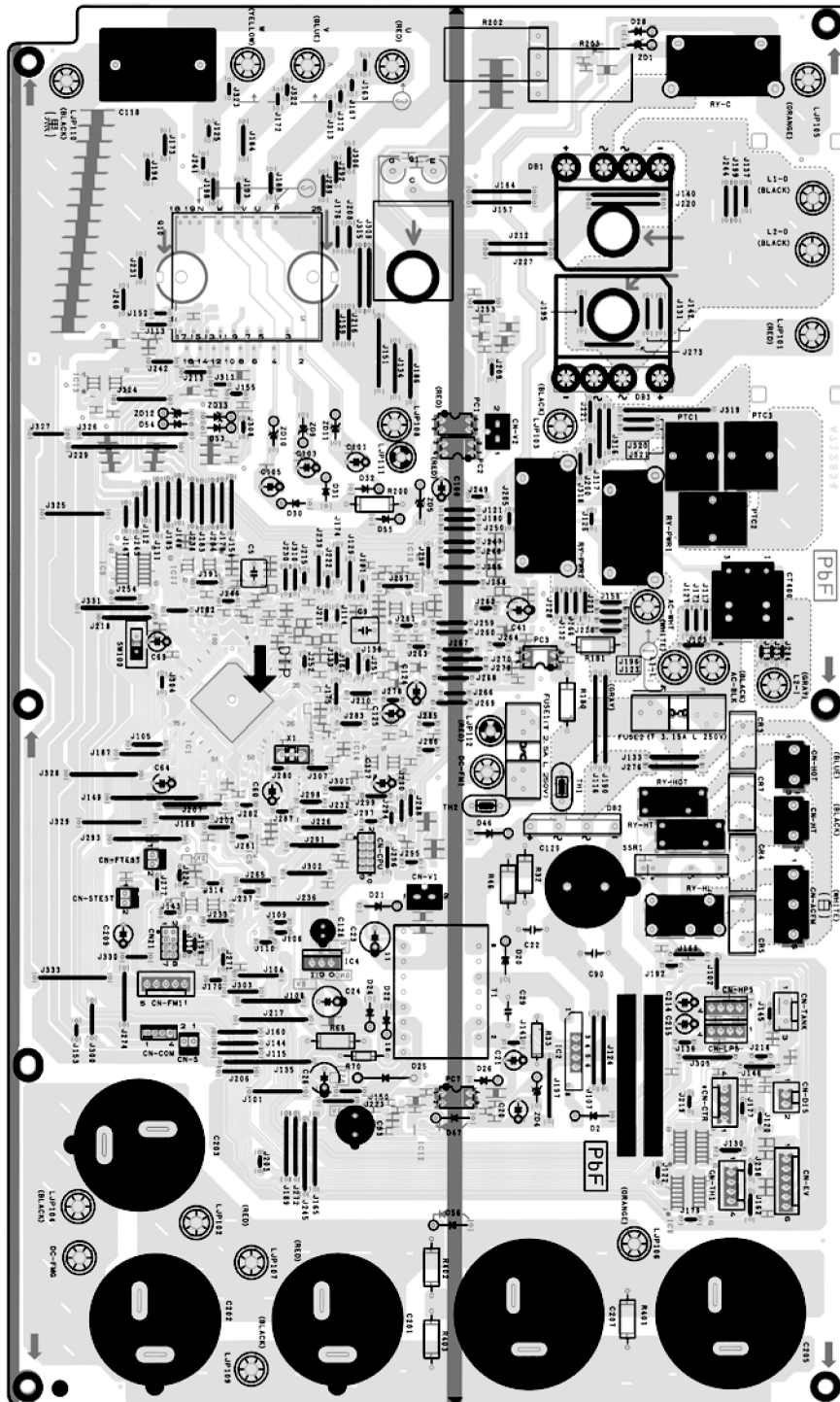

10.2.3. Power Printed Circuit Board

10.2.3.1. CU-RE24JKE-1

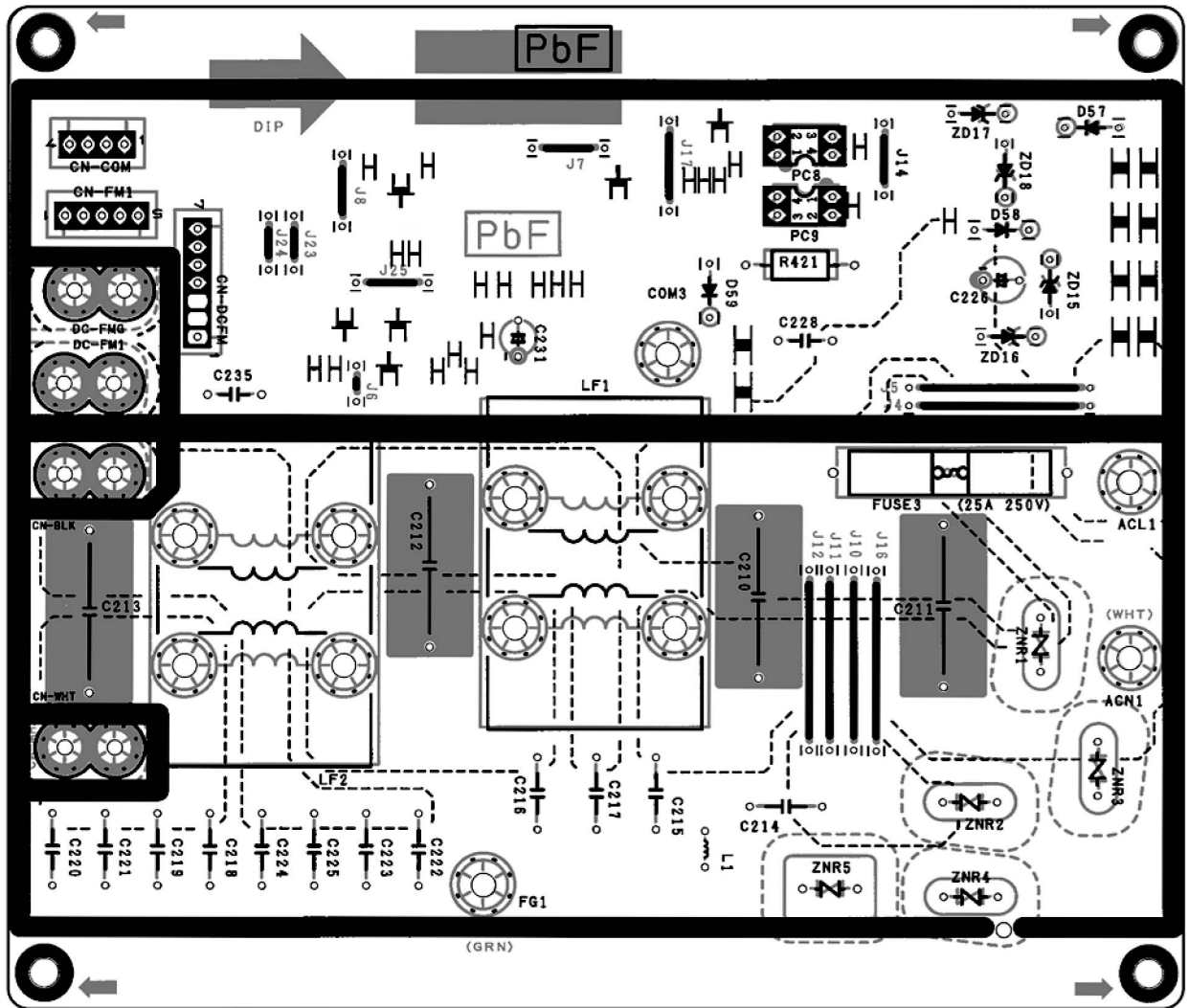

11 Installation Instruction

11.1. Select the Best Location

11.1.1. Indoor Unit

- Do not install the unit in excessive oil fume area such as kitchen, workshop and etc.
- There should not be any heat source or steam near the unit.
- There should not be any obstacles blocking the air circulation.
- A place where air circulation in the room is good.
- A place where drainage can be easily done.
- A place where noise prevention is taken into consideration.
- Do not install the unit near the door way.
- Ensure the spaces indicated by arrows from the wall, ceiling, fence or other obstacles.
- Recommended installation height for indoor unit shall be at least 2.5 m.

11.1.2. Outdoor Unit

- If an awning is built over the unit to prevent direct sunlight or rain, be careful that heat radiation from the condenser is not obstructed.
- There should not be any animal or plant which could be affected by hot air discharged.
- Keep the spaces indicated by arrows from wall, ceiling, fence or other obstacles.
- Do not place any obstacles which may cause a short circuit of the discharged air.
- If piping length is over the [piping length for additional gas], additional refrigerant should be added as shown in the table.

Model	Horse Power (HP)	Piping size		Std. Length (m)	Max. Elevation (m)	Min. Piping Length (m)	Max. Piping Length (m)	Additional Refrigerant (g/m)	Piping Length for add. gas (m)
		Gas	Liquid						
RE18***	2.0HP	1/2"	1/4"	5	15	3	20	20	10
RE24***	2.5HP	5/8"			20	3	30	30	10
RE28***	3.0HP				20	3	30	30	10

Example: For RE18***

If the unit is installed at 15 m distance, the quantity of additional refrigerant should be 100 g (15-10) m x 20 g/m = 100 g.

11.1.3. Indoor/Outdoor Unit Installation Diagram

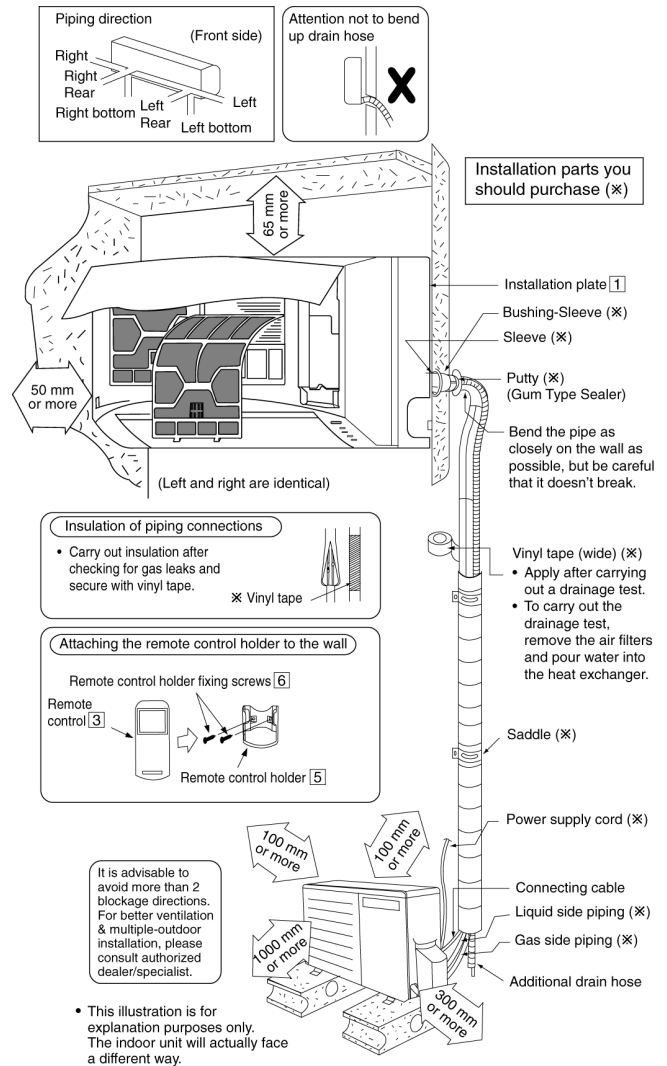

11.2. Indoor Unit

11.2.1. How to Fix Installation Plate

The mounting wall shall be strong and solid enough to prevent it from the vibration.

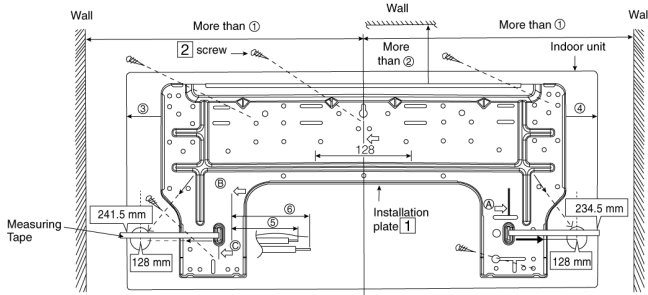

Model	Dimension					
	①	②	③	④	⑤	⑥
RE18***, RE24***, RE28***	585 mm	82 mm	165 mm	158 mm	169 mm	219 mm

The centre of installation plate should be at more than ① at right and left of the wall.

The distance from installation plate edge to ceiling should more than ②.

From installation plate left edge to unit's left side is ③.

From installation plate right edge to unit's right is ④.

- Ⓑ : For left side piping, piping connection for liquid should be about ⑤ from this line.
 : For left side piping, piping connection for gas should be about ⑥ from this line.

- Mount the installation plate on the wall with 5 screws or more (at least 5 screws).
 (If mounting the unit on the concrete wall, consider using anchor bolts.)
 - Always mount the installation plate horizontally by aligning the marking-off line with the thread and using a level gauge.
- Drill the piping plate hole with $\varnothing 70$ mm hole-core drill.
 - Line according to the left and right side of the installation plate. The meeting point of the extended line is the center of the hole. Another method is by putting measuring tape at position as shown in the diagram above. The hole center is obtained by measuring the distance namely 128 mm for left and right hole respectively.
 - Drill the piping hole at either the right or the left and the hole should be slightly slanting to the outdoor side.

11.2.2. To Drill a Hole in the Wall and Install a Sleeve of Piping

- Insert the piping sleeve to the hole.
- Fix the bushing to the sleeve.
- Cut the sleeve until it extrudes about 15 mm from the wall.

CAUTION

When the wall is hollow, please be sure to use the sleeve for tube ass'y to prevent dangers caused by mice biting the connecting cable.

- Finish by sealing the sleeve with putty or caulking compound at the final stage.

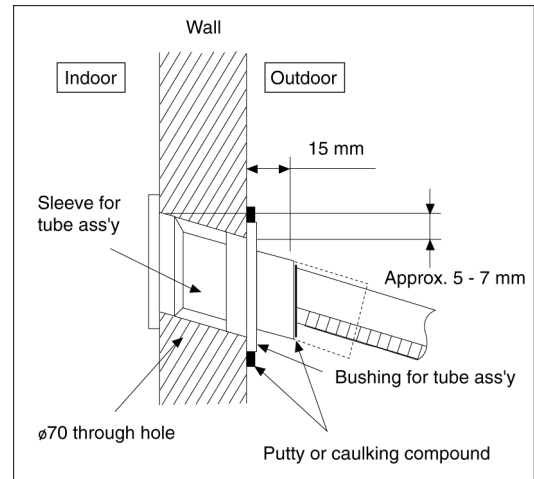

11.2.3. Indoor Unit Installation

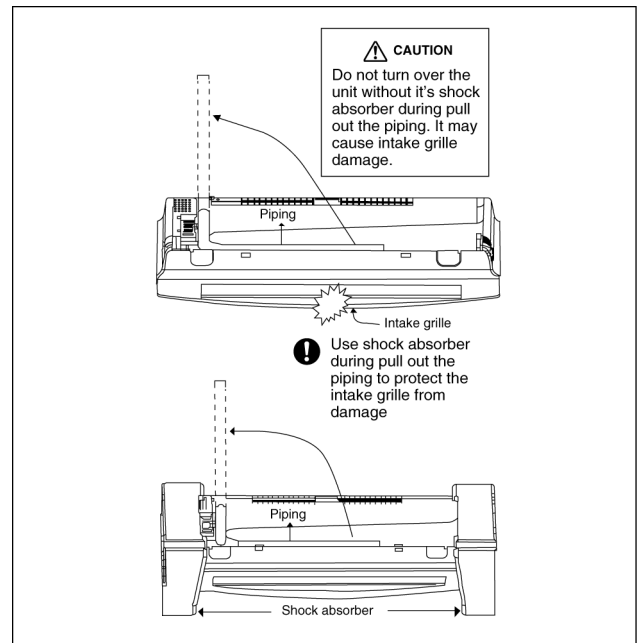

1. For the right rear piping

- Step-1** Pull out the Indoor piping
- ↓
- Step-2** Install the Indoor Unit
- ↓
- Step-3** Secure the Indoor Unit
- ↓
- Step-4** Insert the connecting cable

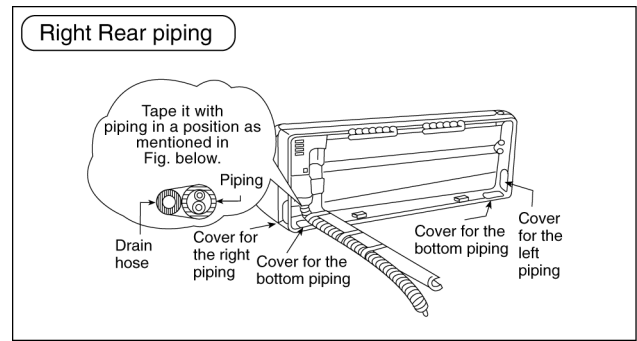

2. For the right and right bottom piping

- Step-1** Pull out the Indoor piping
- ↓
- Step-2** Install the Indoor Unit
- ↓
- Step-3** Insert the connecting cable
- ↓
- Step-4** Secure the Indoor Unit

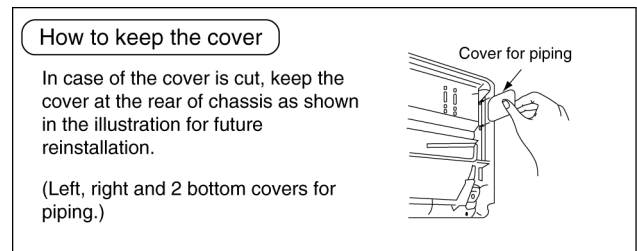

3. For the embedded piping

- Step-1** Replace the drain hose
- ↓
- Step-2** Bend the embedded piping
 - Use a spring bender or equivalent to bend the piping so that the piping is not crushed.
- ↓
- Step-3** Pull the connecting cable into Indoor Unit
 - The inside and outside connecting cable can be connected without removing the front grille.
- ↓
- Step-4** Cut and flare the embedded piping
 - When determining the dimensions of the piping, slide the unit all the way to the left on the installation plate.
 - Refer to the section "Cutting and flaring the piping".
- ↓
- Step-5** Install the Indoor Unit
- ↓
- Step-6** Connect the piping
 - Please refer to "Connecting the piping" column in outdoor unit section. (Below steps are done after connecting the outdoor piping and gas-leakage confirmation.)
- ↓
- Step-7** Insulate and finish the piping
 - Please refer to "Piping and finishing" column of outdoor section and "Insulation of piping connection" column as mentioned in indoor/outdoor unit installation.
- ↓
- Step-8** Secure the Indoor Unit

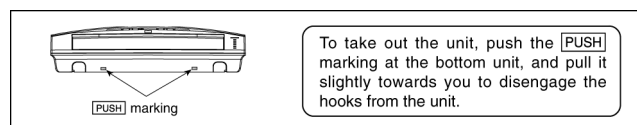
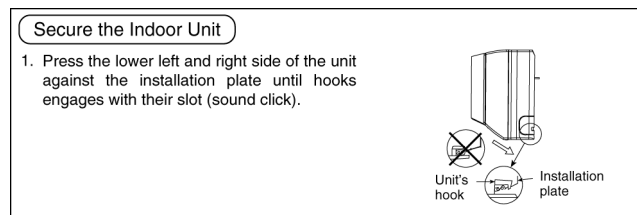
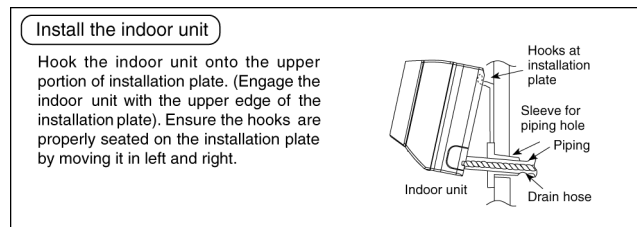
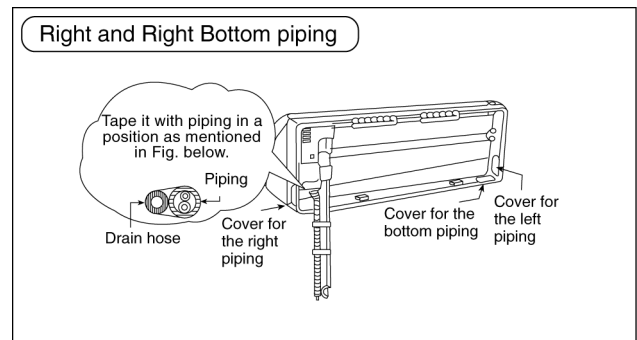

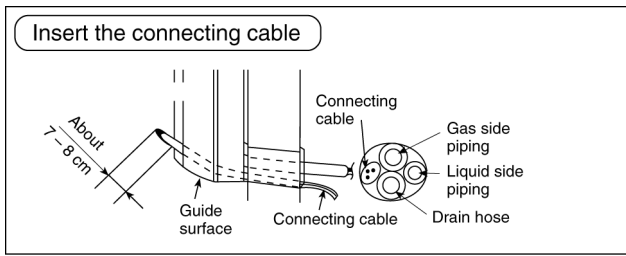

(This can be used for left rear piping and left bottom piping also.)

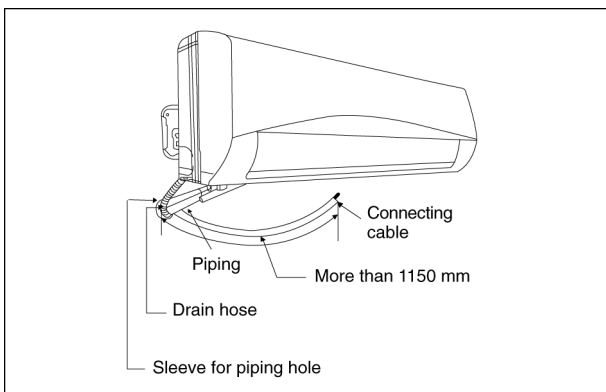
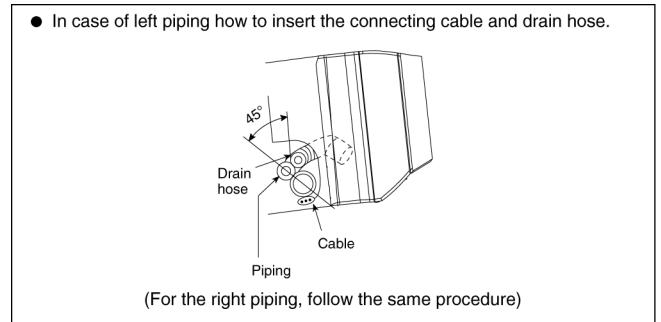
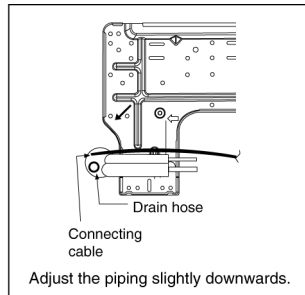
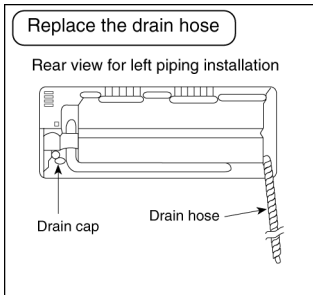
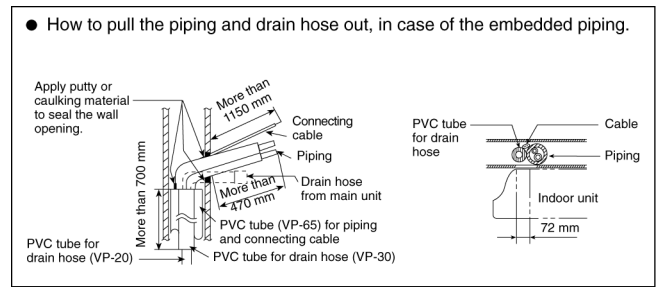

11.2.4. Connect the Cable to the Indoor Unit

1. The inside and outside connecting cable can be connected without removing the front grille.
2. **Connecting cable** between indoor unit and outdoor unit shall be approved polychloroprene sheathed $4 \times 1.5 \text{ mm}^2$ flexible cord, type designation 245 IEC 57 or heavier cord.

Terminals on the indoor unit	1	2	3	
Colour of wires				
Terminals on the outdoor unit	1	2	3	

- Secure the connecting cable onto the control board with the holder (clammer).

This equipment must be properly earthed.

- Ensure the colour of wires of outdoor unit and the terminal Nos. are the same to the indoor's respectively.
- Earth wire shall be Yellow/Green (Y/G) in colour and longer than the other AC wires for safety reason.

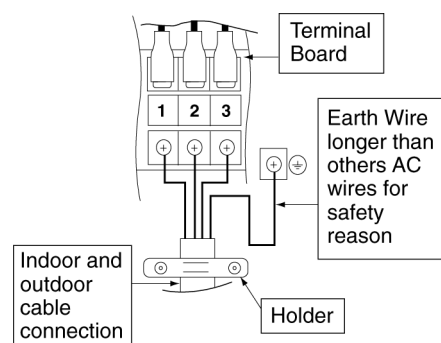

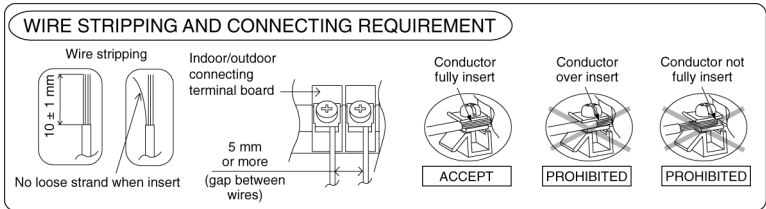

CUTTING AND FLARING THE PIPING

1. Please cut using pipe cutter and then remove the burrs.
2. Remove the burrs by using reamer. If burrs is not removed, gas leakage may be caused.
Turn the piping end down to avoid the metal powder entering the pipe.
3. Please make flare after inserting the flare nut onto the copper pipes.

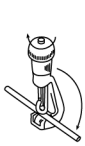

1. To cut

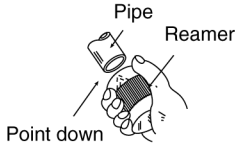

2. To remove burrs

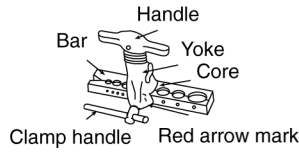

3. To flare

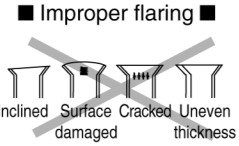
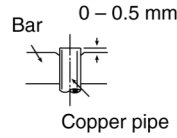

When properly flared, the internal surface of the flare will evenly shine and be of even thickness. Since the flare part comes into contact with the connections, carefully check the flare finish.

11.3. Outdoor Unit

11.3.1. Install the Outdoor Unit

- After selecting the best location, start installation according to Indoor/Outdoor Unit Installation Diagram.
 - Fix the unit on concrete or rigid frame firmly and horizontally by bolt nut ($\phi 10$ mm).
 - When installing at roof, please consider strong wind and earthquake. Please fasten the installation stand firmly with bolt or nails.

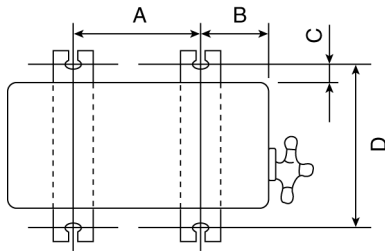

Model	A	B	C	D
RE18***	612.5 mm	131 mm	19 mm	383 mm
RE24***, RE28***	613 mm	131 mm	16 mm	360.5 mm

11.3.2. Connecting the Piping

Connecting the Piping to Indoor Unit

Please make flare after inserting flare nut (locate at joint portion of tube assembly) onto the copper pipe.

(In case of using long piping)

Connect the piping

- Align the center of piping and sufficiently tighten the flare nut with fingers.
- Further tighten the flare nut with torque wrench in specified torque as stated in the table.

CAUTION	
Do not over tighten, over tightening cause gas leakage.	
Piping size	Torque
1/4" (6.35 mm)	[18 N•m (1.8 kgf.m)]
3/8" (9.52 mm)	[42 N•m (4.3 kgf.m)]
1/2" (12.7 mm)	[55 N•m (5.6 kgf.m)]
5/8" (15.88 mm)	[65 N•m (6.6 kgf.m)]
3/4" (19.05 mm)	[100 N•m (10.2 kgf.m)]

Connecting the Piping to Outdoor

Decide piping length and then cut by using pipe cutter. Remove burrs from cut edge. Make flare after inserting the flare nut (located at valve) onto the copper pipe.

Align center of piping to valves and then tighten with torque wrench to the specified torque as stated in the table.

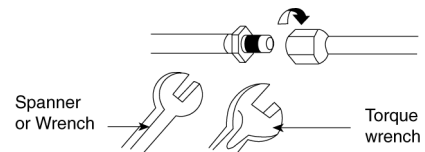

11.3.3. Evacuation of the Equipment

WHEN INSTALLING AN AIR CONDITIONER, BE SURE TO EVACUATE THE AIR INSIDE THE INDOOR UNIT AND PIPES in the following procedure.

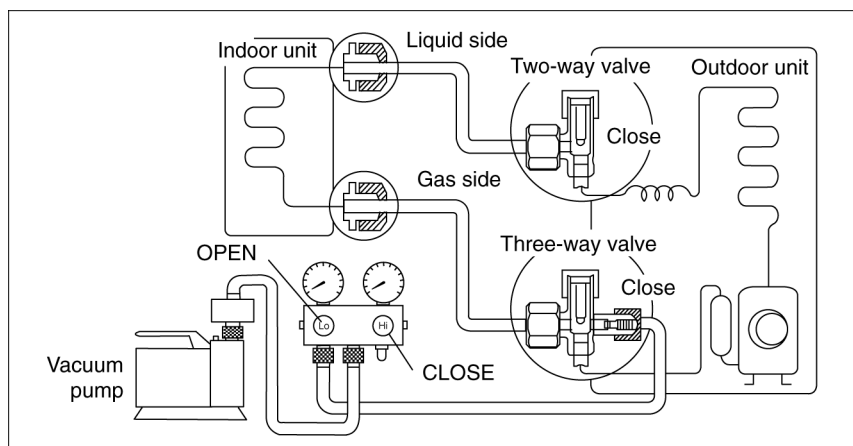

- Connect a charging hose with a push pin to the Low side of a charging set and the service port of the 3-way valve.
 - Be sure to connect the end of the charging hose with the push pin to the service port.
- Connect the center hose of the charging set to a vacuum pump.
- Turn on the power switch of the vacuum pump and make sure that the needle in the gauge moves from 0 cmHg (0 MPa) to -76 cmHg (-0.1 MPa). Then evacuate the air approximately ten minutes.

4. Close the Low side valve of the charging set and turn off the vacuum pump. Make sure that the needle in the gauge does not move after approximately five minutes.
Note: BE SURE TO TAKE THIS PROCEDURE IN ORDER TO AVOID REFRIGERANT GAS LEAKAGE.
5. Disconnect the charging hose from the vacuum pump and from the service port of the 3-way valve.
6. Tighten the service port caps of the 3-way valve at a torque of 18 N•m with a torque wrench.
7. Remove the valve caps of both of the 2-way valve and 3-way valve. Position both of the valves to "OPEN" using a hexagonal wrench (4 mm).
8. Mount valve caps onto the 2-way valve and the 3-way valve.
 - Be sure to check for gas leakage.

⚠ CAUTION

- If gauge needle does not move from 0 cmHg (0 MPa) to -76 cmHg (-0.1 MPa), in step ③ above take the following measure:
 - If the leak stops when the piping connections are tightened further, continue working from step ③.
 - If the leak does not stop when the connections are retightened, repair the location of leak.
 - Do not release refrigerant during piping work for installation and reinstallation.
 - Take care of the liquid refrigerant, it may cause frostbite.

11.3.4. Connect the Cable to the Outdoor Unit

1. Remove the control board cover from the unit by loosening the screw.
2. Cable connection to the power supply through Isolating Devices (Disconnecting means).
 - Connect the approved polychloroprene sheathed **power supply cord** 3 × 2.5 mm² (2.0 ~ 2.5HP) or 3 × 4.0 mm² (3.0HP) type designation 245 IEC 57 or heavier cord to the terminal board, and connect the others end of the cord to Isolating Devices (Disconnecting means).
3. **Connecting cable** between indoor unit and outdoor unit shall be approved polychloroprene sheathed 4 × 1.5 mm² flexible cord, type designation 245 IEC 57 or heavier cord.
4. Connect the power supply cord and connecting cable between indoor unit and outdoor unit according to the diagram below.

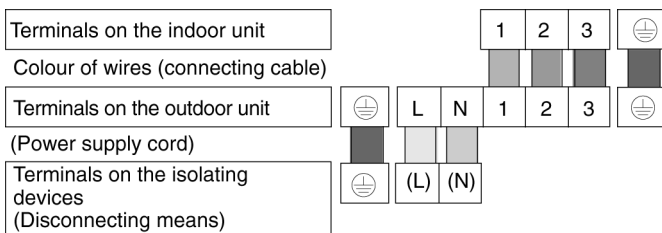
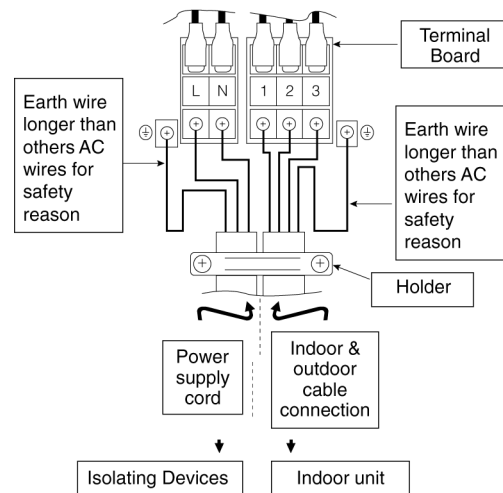

5. Secure the power supply cord and connecting cable onto the control board with the holder.
6. Attach the control board cover back to the original position with screw.
7. For wire stripping and connection requirement, refer to instruction ⑤ of indoor unit.



This equipment must be properly earthed.

- Note: Isolating Devices (Disconnecting means) should have minimum 3.0 mm contact gap.
- Earth wire shall be Yellow/Green (Y/G) in colour and longer than other AC wires for safety reason.

11.3.5. Pipe Insulation

1. Please carry out insulation at pipe connection portion as mentioned in Indoor/Outdoor Unit Installation Diagram. Please wrap the insulated piping end to prevent water from going inside the piping.
2. If drain hose or connecting piping is in the room (where dew may form), please increase the insulation by using POLY-E FOAM with thickness 6mm or above.

12 Operation and Control

12.1. Basic Function

Inverter control, which is equipped with a microcomputer, determines the most suitable operating mode as time passes, automatically adjusting output power for maximum comfort. In order to achieve the suitable operating mode, the microcomputer maintains the set temperature by measuring the temperature of the environment and performing temperature shifting. The compressor at the outdoor unit is operating following the frequency instructed by the microcomputer at the indoor unit, judging the condition according to the internal setting temperature and intake air temperature.

12.1.1. Internal Setting Temperature

Once the operation starts, the remote control setting temperature will be taken as the base value for temperature shifting processes. These shifting processes depend on the air conditioner settings and the operation environment. The final shifted value will be used as the internal setting temperature and is updated continuously whenever the electrical power is supplied to the unit.

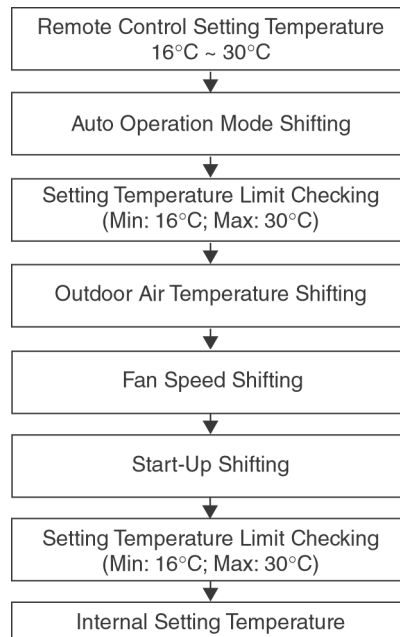

12.1.2. Cooling Operation

12.1.2.1. Thermostat control

- Compressor is OFF when Intake Air Temperature - Internal Setting Temperature < -1.5°C.
- Compressor is ON after waiting for 3 minutes, if the Intake Air Temperature - Internal Setting Temperature > Compressor OFF point.

12.1.3. Soft Dry Operation

12.1.3.1. Thermostat control

- Compressor is OFF when Intake Air Temperature - Internal Setting Temperature < -2.0°C.
- Compressor is ON after waiting for 3 minutes, if the Intake Air Temperature - Internal Setting Temperature > Compressor OFF point.

12.1.4. Heating Operation

12.1.4.1. Thermostat control

- Compressor is OFF when Intake Air Temperature - Internal Setting Temperature > +2.0°C.
- Compressor is ON after waiting for 3 minutes, if the Intake Air Temperature - Internal Setting Temperature < Compressor OFF point.

12.1.5. Automatic Operation

- This mode can be set using remote control and the operation is decided by remote control setting temperature, remote control operation mode, indoor intake air temperature and outdoor air temperature.
- During operation mode judgment, indoor fan motor (with speed of Lo-) and outdoor fan motor are running for 30 seconds to detect the indoor intake and outdoor air temperature. The operation mode is decided based on below chart.

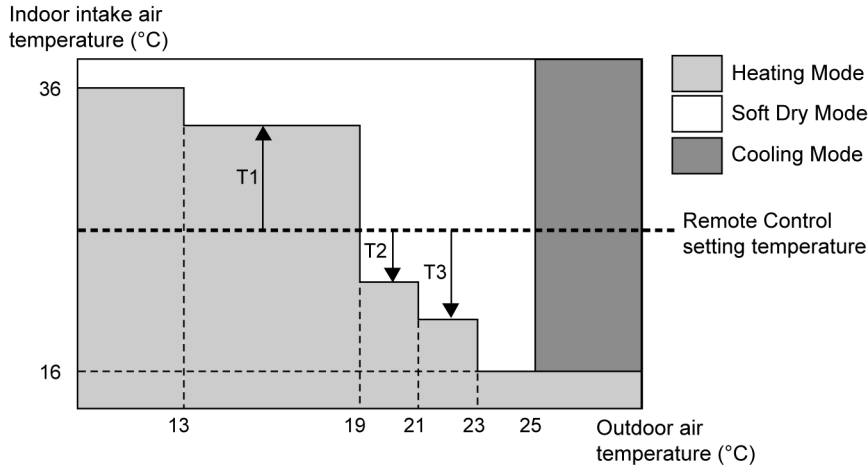

Every 30 minutes, the indoor and outdoor temperature is judged. Based on remote control setting temperature, the value of T1 will increase up to 10°C, T2 will decreased by 3°C and T3 will decreased up to 8°C. The Auto Operation Mode shifting will take place whenever operation mode changed from Cooling/Soft Dry to Heating or vice versa.

12.1.6. Indoor Fan Motor Operation

A. Basic Rotation Speed (rpm)

i. Manual Fan Speed

[Cooling, Dry]

- Fan motor's number of rotation is determined according to remote control setting.

Remote Control	O	O	O	O	O
Tab (rpm)	Hi	Me+	Me	Me-	Lo

[Heating]

- Fan motor's number of rotation is determined according to remote control setting.

Remote Control	O	O	O	O	O
Tab (rpm)	Shi	Me+	Me	Me-	Lo

ii. Auto Fan Speed

[Cooling, Dry]

- According to room temperature and setting temperature, indoor fan speed is determined automatically.
- The indoor fan will operate according to pattern below.

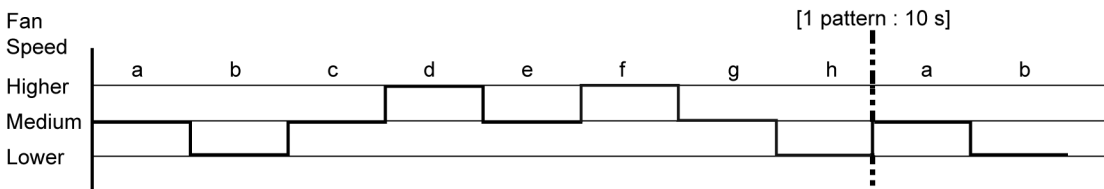

[Heating]

- According to indoor pipe temperature, automatic heating fan speed is determined as follows.

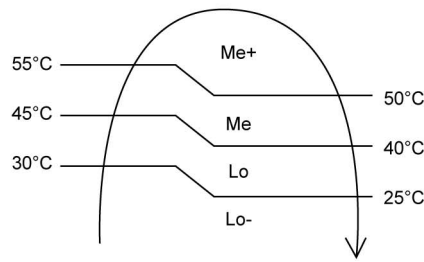

B. Feedback control

- Immediately after the fan motor started, feedback control is performed once every second.
- During fan motor on, if fan motor feedback ≥ 2550 rpm or < 50 rpm continue for 10 seconds, then fan motor error counter increase, fan motor is then stop and restart. If the fan motor counter becomes 7 times, then H19 - fan motor error is detected. Operation stops and cannot on back.

12.1.7. Outdoor Fan Motor Operation

Outdoor fan motor is operated with one fan speed only. It starts when compressor starts operation and it stops 30 seconds after compressor stops operation.

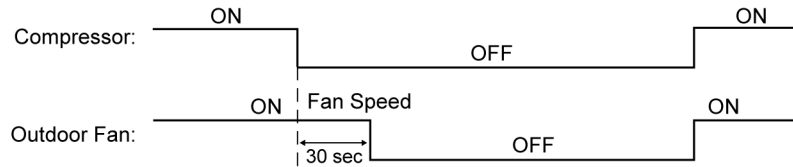

12.2. Airflow Direction

1. There are two types of airflow, vertical airflow (directed by horizontal vane) and horizontal airflow (directed by vertical vanes).
2. Control of airflow direction can be automatic (angles of direction is determined by operation mode, heat exchanger temperature and intake air temperature) and manual (angles of direction can be adjusted using remote control).

12.2.1. Vertical Airflow

Operation Mode	Airflow Direction	Vane Angle (°)					
		1	2	3	4	5	
Heating	Auto with Heat Exchanger	A	20				
		B	45				
		C	32				
	Manual	20	32	45	57	68	
Cooling and e-ion	Auto	20 ~ 45					
	Manual	20	26	32	37	45	
Soft Dry	Auto	20 ~ 45					
	Manual	20	26	32	37	45	

1. Automatic vertical airflow direction can be set using remote control; the vane swings up and down within the angles as stated above. For heating mode operation, the angle of the vane depends on the indoor heat exchanger temperature as Figure 1 below. When the air conditioner is stopped using remote control, the vane will shift to close position.
2. Manual vertical airflow direction can be set using remote control; the angles of the vane are as stated above and the positions of the vane are as Figure 2 below. When the air conditioner is stopped using remote control, the vane will shift to close position.

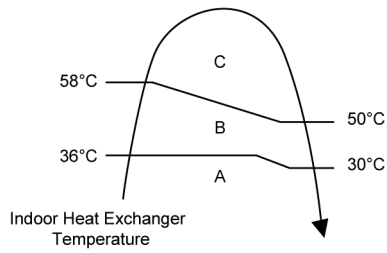

Figure 1

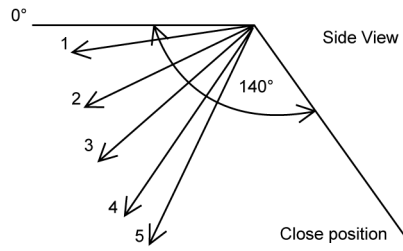

Figure 2

12.2.2. Horizontal Airflow

1. Automatic horizontal airflow direction can be set using remote control; the vane swings left and right within the angles as stated below. For heating mode operation, the angle of the vane depends on the indoor heat exchanger temperature as Figure 1 below.

Operation Mode		Vane Angle (°)
Heating, with heat exchanger temperature	A	68 ~ 112
	B	90
Cooling and Soft Dry		68 ~ 112

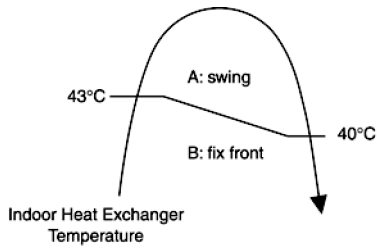

Figure 1

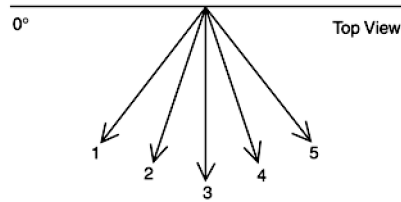

Figure 2

2. Manual horizontal airflow direction can be set using remote control; the angles of the vane are as stated below and the positions of the vane are as Figure 2 above.

Pattern	1	2	3	4	5
Airflow Direction Patterns at Remote Control					
Vane Angle (°)	90	68	78	102	112

12.3. ON Timer Control

ON timer can be set using remote control, the unit with timer set will start operate earlier than the setting time. This is to provide a comfortable environment when reaching the set ON time.

60 minutes before the set time, indoor (at fan speed of Lo-) and outdoor fan motor start operate for 30 seconds to determine the indoor intake air temperature and outdoor air temperature in order to judge the operation starting time.

From the above judgment, the decided operation will start operate earlier than the set time as shown below.

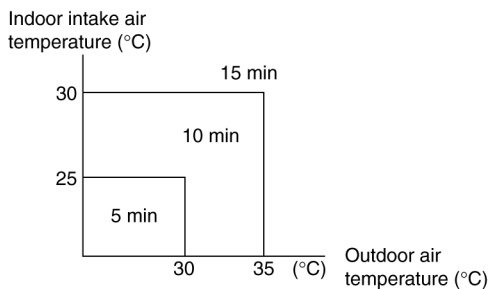

Cooling/Soft Dry

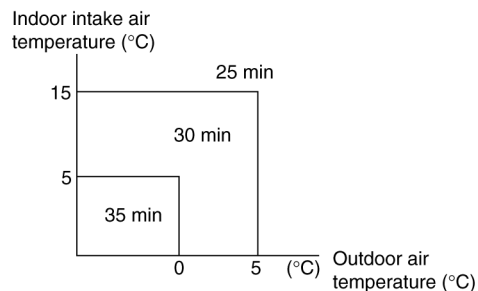

Heating

12.4. OFF Timer Control

OFF timer can be set using remote control, the unit with timer set will stop operate at set time.

12.5. Auto Restart Control

1. When the power supply is cut off during the operation of air conditioner, the compressor will re-operate within three to four minutes (there are 10 patterns between 2 minutes 58 seconds and 3 minutes 52 seconds to be selected randomly) after power supply resumes.
2. This type of control is not applicable during ON/OFF Timer setting.

13 Protection Control

13.1. Protection Control For All Operations

13.1.1. Time Delay Safety Control

1. The compressor will not start for three minutes after stop of operation.
2. This control is not applicable if the power supply is cut off and on again or after 4-way valve deices condition.

13.1.2. 30 Seconds Forced Operation

1. Once the compressor starts operation, it will not stop its operation for 30 seconds.
2. However, it can be stopped using remote control or Auto Switch at indoor unit.

13.1.3. Total Running Current Control

1. When the outdoor unit total running current (AC) exceeds X value, the frequency instructed for compressor operation will be decreased.
2. If the running current does not exceed X value for five seconds, the frequency instructed will be increased.
3. However, if total outdoor unit running current exceeds Y value, compressor will be stopped immediately for 3 minutes.

Operation Mode	RE18JK		RE24JK	
	X (A)	Y (A)	X (A)	Y (A)
Cooling/Soft Dry (A)	10.7	15.0	11.0	15.0
Cooling/Soft Dry (B)	7.7	15.0	9.6	15.0
Heating	10.7	15.0	11.5	15.0

4. The first 30 minutes of cooling operation, (A) will be applied.

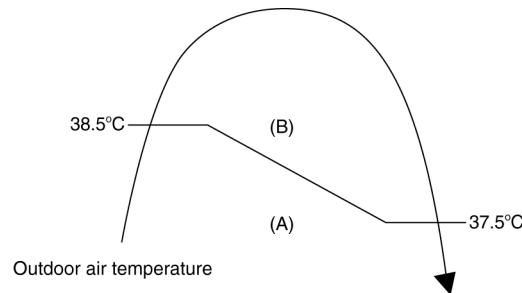

13.1.4. IPM (Power transistor) Prevention Control

A. Overheating Prevention Control

1. When the IPM temperature rises to 110°C, compressor operation will stop immediately.
2. Compressor operation restarts after three minutes the temperature decreases to 95°C.
3. If this condition repeats continuously 4 times within 20 minutes, timer LED will be blinking ("F96 is indicated).

B. DC Peak Current Control

1. When electric current to IPM exceeds set value of 30.0 ± 5.0 A, the compressor will stop operate. Then, operation will restart after three minutes.
2. If the set value is exceeded again more than 30 seconds after the compressor starts, the operation will restart after two minutes.
3. If the set value is exceeded again within 30 seconds after the compressor starts, the operation will restart after one minute. If this condition repeats continuously for seven times, all indoor and outdoor relays will be cut off, timer LED will be blinking ("F99" is indicated).

13.1.5. Compressor Overheating Prevention Control

Instructed frequency for compressor operation will be regulated by compressor discharge temperature. The changes of frequency are as below figure.

If compressor discharge temperature exceeds 112°C, compressor will be stop, occurs 4 times per 20 minutes, timer LED will be blinking ("F97" is to be confirmed).

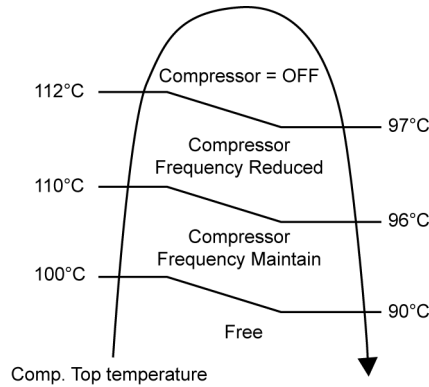

13.1.6. Low Pressure Prevention Control (Gas Leakage Detection)

a. Control start conditions

- For 5 minutes, the compressor continuously operates and outdoor total current is between 0.65A and 1.65A.
- During Cooling and Soft Dry operations:
Indoor suction temperature - indoor piping temperature is below 4°C.
- During Heating operations :
Indoor piping temperature - indoor suction is under 5°C.

b. Control contents

- Compressor stops (and restart after 3 minutes).
- If the conditions above happen 2 times within 20 minutes, the unit will:
 - Stop operation
 - Timer LED blinks and "F91" indicated.

13.1.7. Compressor Tank Temperature Rise Protection Control

a. Control start conditions

- For 5 minutes, the compressor continuously operates and outdoor total current is between 0.65A and 1.65A.
- During Cooling and Soft Dry operations:
Indoor suction temperature - indoor piping temperature is below 4°C.
Indoor temperature and outdoor temperature is 30±5°C.
Remote Control setting 16°C and Hi Fan Speed.
- During Heating operations:
Indoor piping temperature - indoor suction is under 5°C.
Indoor temperature and outdoor temperature is 20±2°C.
Remote control setting 30°C and Hi Fan Speed.

b. Control contents

- Compressor stops (and restart after 3 minutes)
- If the conditions above happen 2 times within 20 minutes, the unit will:
 - Stop operation
 - Timer LED blinks and "F91" indicated

13.1.8. Low Frequency Protection Control 1

- When the compressor operate at frequency lower than 24 Hz continued for 20 minutes, the operation frequency will be changed to 23 Hz for 2 minutes.

13.1.9. Low Frequency Protection Control 2

- When all the below conditions comply, the compressor frequency will change to lower frequency.

Temperature, T, for:	Cooling/Soft Dry	Heating
Indoor intake air (°C)	$T < 15$ or $T \geq 30$	—
Outdoor air (°C)	$T < 16$ or $T \geq 38$	$T < 4$ or $T \geq 24$
Indoor heat exchanger (°C)	$T < 30$	$T \geq 0$

13.2. Protection Control For Cooling & Soft Dry Operation

13.2.1. Outdoor Air Temperature Control

The compressor operating frequency is regulated in accordance to the outdoor air temperature as shown in the diagram below. This control will begin 1 minute after the compressor starts. Compressor frequency will adjust base on Outdoor Air Temperature.

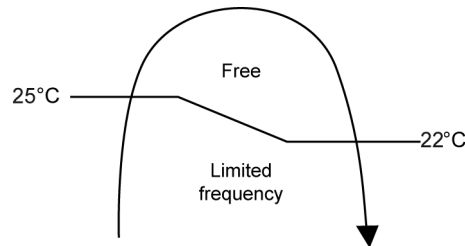

13.2.2. Cooling Overload Control

- i. Pipe temperature limitation/restriction
 - Detects the Outdoor pipe temperature and carry out below restriction/limitation (Limit the compressor Operation frequency)
 - The compressor stop if outdoor pipe temperature exceeds 63°C.
 - If the compressor stops 4 times in 20 minutes, Timer LED blinking (F95: outdoor high pressure rise protection)

13.2.3. Dew Prevention Control 1

1. To prevent dew formation at indoor unit discharge area.
2. This control activated if:
 - Outdoor air temperature and Indoor pipe temperature judgment by microcontroller if fulfilled.
 - When Cooling or Dry mode is operated more than 20 minutes or more.
3. This control stopped if:
 - Compressor stopped.
 - Remote control setting changed. (fan speed / temperature)
 - Outdoor air temperature and indoor intake temperature changed.
4. Fan speed, angle of louver (vertical airflow angle) will be adjusted accordingly in this control.
 - Fan speed will be increased slowly if the unit is in quiet mode but no change in normal cooling mode.

13.2.4. Dew Prevention Control 2

1. To prevent dew formation at indoor unit discharge area.
2. This control starts if all conditions continue for 20 minutes:
 - Operated with Cooling or Soft Dry Mode.
 - Indoor intake temperature is between 25°C and 29°C.
 - Outdoor air temperature is less than 30°C.
 - Quiet Lo fan speed.
3. This control stopped if:
 - When receive air swing change signal from Remote Control.
4. The horizontal louver will be fixed at 26° (regardless of Auto or Manual Airflow Direction Setting)
5. The vertical louver will be fixed front.

13.2.5. Freeze Prevention Control 1

1. When indoor heat exchanger temperature is lower than 0°C continuously for six minutes, compressor will stop operating.
2. Compressor will resume its operation three minutes after the indoor heat exchanger is higher than 13°C.
3. At the same time, indoor fan speed will be higher than during its normal operation.
4. If indoor heat exchanger temperature is higher than 13°C for five minutes, the fan speed will return to its normal operation.

13.2.6. Freeze Prevention Control 2

1. Control start conditions
 - During Cooling operation and soft dry operation.
 - During thermo OFF condition, indoor intake temperature is less than 10°C or
 - Compressor stops for freeze prevention control
 - Either one of the conditions above occurs 5 times in 60 minutes.
2. Control contents
 - Operation stops.
 - Timer LED blinks and "H99" indicated.

13.3. Protection Control For Heating Operation

13.3.1. Intake Air Temperature Control

Compressor will operate at maximum frequency if below conditions occur:

1. When the indoor intake air temperature is 30°C or above.

13.3.2. Outdoor Air Temperature Control

The maximum current value is regulated when the outdoor air temperature rises above 14°C in order to avoid compressor overloading.

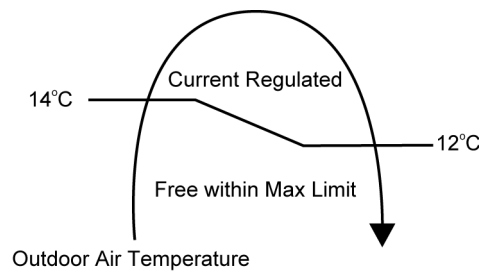

13.3.3. Overload Protection Control

The compressor operating frequency is regulated in accordance to indoor heat exchanger temperature as shown in below figures.

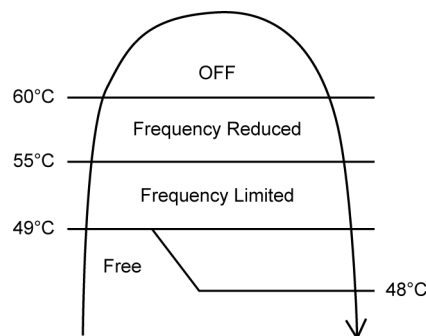

13.3.4. Cold Draught Prevention Control

When indoor pipe temperature is low, cold draught operation starts where indoor fan speed will be reduced.

13.3.5. Deice Operation

When outdoor pipe temperature and outdoor air temperature is low, deice operation start where indoor fan motor and outdoor fan motor stop and operation LED blinks.

14 Servicing Mode

14.1. Auto OFF/ON Button

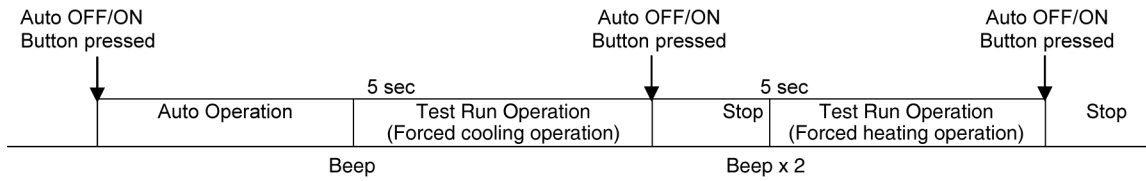

1. AUTO OPERATION MODE

The Auto operation will be activated immediately once the Auto OFF/ON button is pressed. This operation can be used to operate air conditioner with limited function if remote control is misplaced or malfunction.

2. TEST RUN OPERATION (FOR PUMP DOWN/SERVICING PURPOSE)

The Test Run operation will be activated if the Auto OFF/ON button is pressed continuously for more than 5 seconds. A “beep” sound will occur at the fifth seconds, in order to identify the starting of Test Run operation (Forced cooling operation). Within 5 minutes after Forced cooling operation start, the Auto OFF/ON button is pressed for more than 5 seconds. A 2 “beep” sounds will occur at the fifth seconds, in order to identify the starting of Forced heating operation.

The Auto OFF/ON button may be used together with remote control to set / change the advance setting of air conditioner operation.

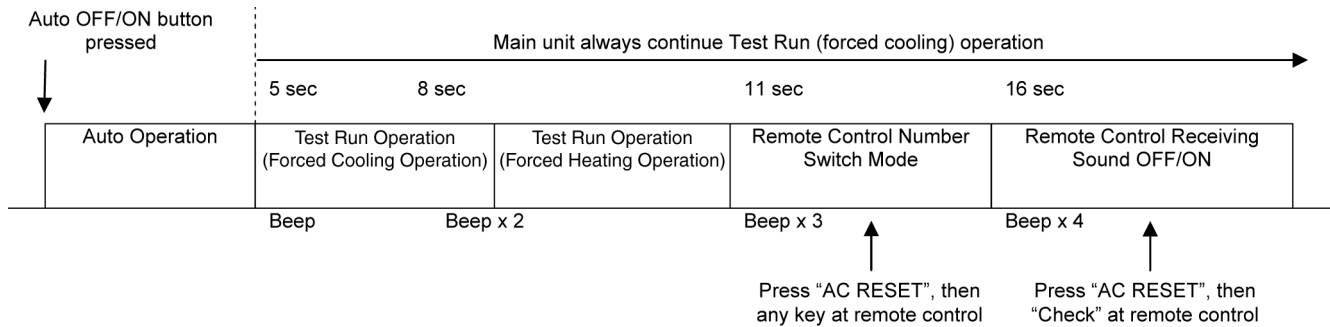

3. REMOTE CONTROL NUMBER SWITCH MODE

The Remote Control Number Switch Mode will be activated if the Auto OFF/ON button is pressed continuously for more than 11 seconds (3 “beep” sounds will occur at 11th seconds to identify the Remote Control Number Switch Mode is in standby condition) and press “AC RESET” button and then press any button at remote control to transmit and store the desired transmission code to the EEPROM.

There are 4 types of remote control transmission code could be selected and stored in EEPROM of indoor unit. The indoor unit will only operate when received signal with same transmission code from remote control. This could prevent signal interference when there are 2 or more indoor units installed nearby together.

To change remote control transmission code, short or open jumpers at the remote control printed circuit board

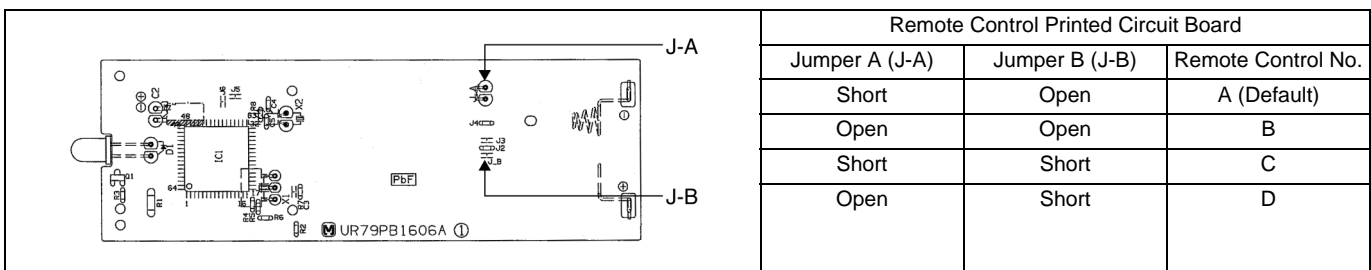

4. REMOTE CONTROL RECEIVING SOUND OFF/ON MODE

The Remote Control Receiving Sound OFF/ON Mode will be activated if the Auto OFF/ON button is pressed continuously for more than 16 seconds (4 “beep” sounds will occur at 16th seconds to identify the Remote Control Receiving Sound Off/On Mode is in standby condition) and press “AC Reset” button and then press “Check” button at remote control.

Press “Auto OFF/ON button” to toggle remote control receiving sound.

- Short “beep”: Turn OFF remote control receiving sound.
- Long “beep”: Turn ON remote control receiving sound.

After Auto OFF/ON Button is pressed, the 20 seconds counter for Remote Control Receiving Sound OFF/ON Mode is restarted.

14.2. Remote Control Button

14.2.1. SET BUTTON

- To check remote control transmission code and store the transmission code to EEPROM.
 - Press “SET” button for more than 10 seconds by using pointer.
 - Press “TIMER SET” button until a “beep” sound is heard as confirmation of transmission code change.
- To change the air quality sensor sensitivity
 - Press and release by using pointer.
 - Press the Timer Decrement button to select sensitivity:
 1. Low Sensitivity
 2. Standard (Default)
 3. Hi Sensitivity
 - Confirm setting by pressing Timer Set button, a “Beep” sound will be heard. LCD returns to original display after 2 seconds.
 - LCD returns to original display if remote control does not operate for 30 seconds.

14.2.2. CLOCK BUTTON

- To change the remote control's time format
 - Press for more than 5 seconds.

14.2.3. RESET (RC)

- To clear and restore the remote control setting to factory default
 - Press once to clear the memory.

14.2.4. RESET (AC)

- To restore the unit's setting to factory default
 - Press once to restore the unit's setting.

14.2.5. TIMER ▲

- To change indoor unit indicator's LED intensity
 - Press continuously for 5 seconds.

14.2.6. TIMER ▼

- To change remote control display from Degree Celsius to Degree Fahrenheit.
 - Press continuously for 10 seconds.

15 Troubleshooting Guide

15.1. Refrigeration Cycle System

In order to diagnose malfunctions, make sure that there are no electrical problems before inspecting the refrigeration cycle. Such problems include insufficient insulation, problem with the power source, malfunction of a compressor and a fan. The normal outlet air temperature and pressure of the refrigeration cycle depends on various conditions, the standard values for them are shown in the table on the right.

Normal Pressure and Outlet Air Temperature (Standard)

	Gas pressure MPa (kg/cm ² G)	Outlet air temperature (°C)
Cooling Mode	0.9 ~ 1.2 (9 ~ 12)	12 ~ 16
Heating Mode	2.3 ~ 2.9 (23 ~ 29)	36 ~ 45

- ★ Condition:
- Indoor fan speed; High
 - Outdoor temperature 35°C at cooling mode and 7°C at heating mode.
 - Compressor operates at rated frequency

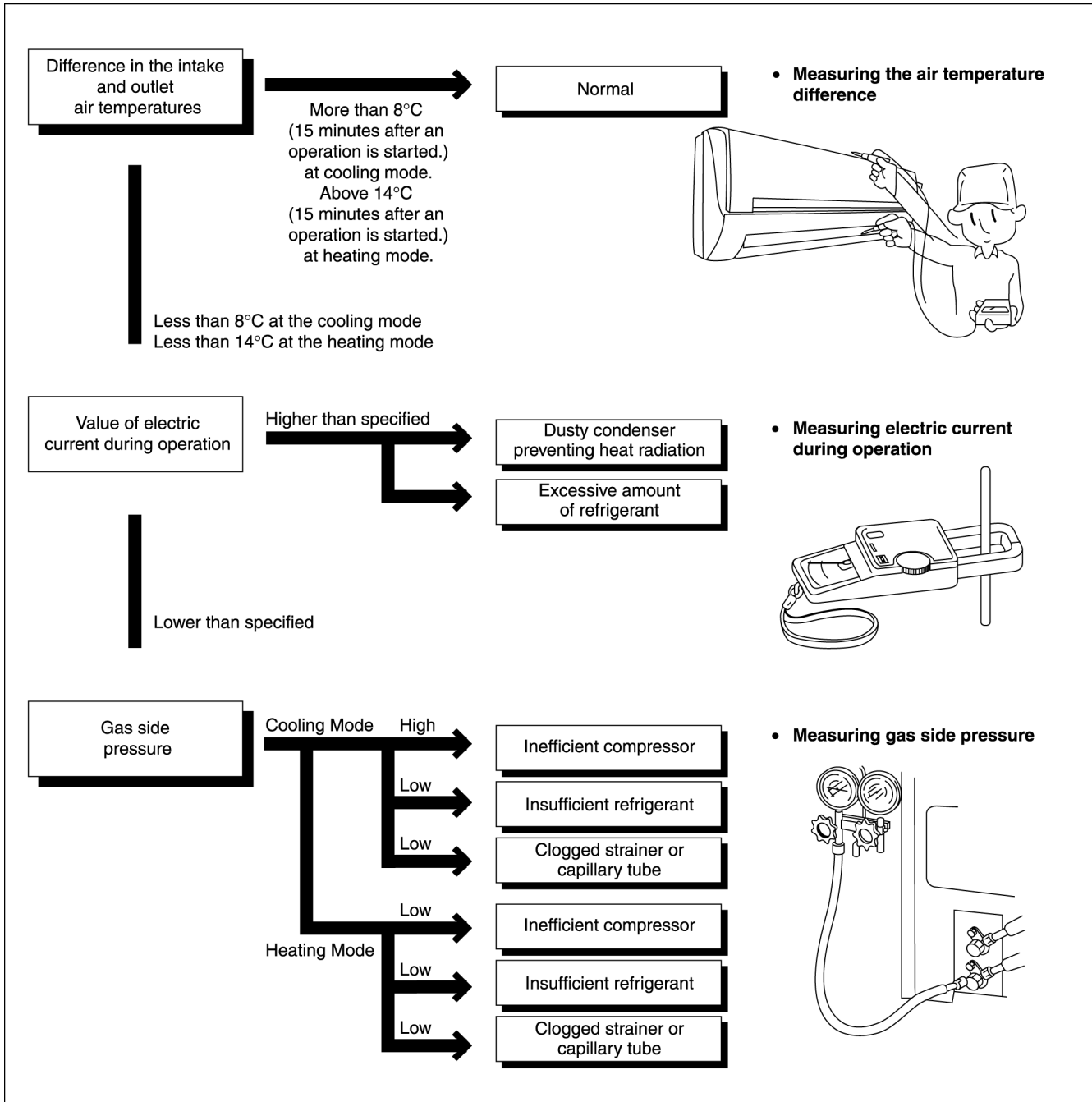

15.2. Relationship Between The Condition Of The Air Conditioner And Pressure And Electric Current

Condition of the air conditioner	Cooling Mode			Heating Mode		
	Low Pressure	High Pressure	Electric current during operation	Low Pressure	High Pressure	Electric current during operation
Insufficient refrigerant (gas leakage)						
Clogged capillary tube or Strainer						
Short circuit in the indoor unit						
Heat radiation deficiency of the outdoor unit						
Inefficient compression						

- Carry out the measurements of pressure, electric current, and temperature fifteen minutes after an operation is started.

15.3. Breakdown Self Diagnosis Function

15.3.1. Self Diagnosis Function (Three Digits Alphanumeric Code)

- Once abnormality has occurred during operation, the unit will stop its operation, and Timer LEDs blink.
- Although Timer LED goes off when power supply is turned off, if the unit is operated under a breakdown condition, the LED will light up again.
- In operation after breakdown repair, the Timer LED will no more blink. The last error code (abnormality) will be stored in IC memory.

• To make a diagnosis

1. Timer LED start to blink and the unit automatically stops the operation.
2. Press the CHECK button on the remote controller continuously for 5 seconds.
3. “- -” will be displayed on the remote controller display.
Note: Display only for “- -”. (No transmitting signal, no receiving sound and no Power LED blinking.)
4. Press the “TIMER” ▲ or ▼ button on the remote controller. The code “H00” (no abnormality) will be displayed and signal will be transmitted to the main unit.
5. Every press of the button (up or down) will increase abnormality numbers and transmit abnormality code signal to the main unit.
6. When the latest abnormality code on the main unit and code transmitted from the remote controller are matched, power LED will light up for 30 seconds and a beep sound (continuously for 4 seconds) will be heard. If no codes are matched, power LED will light up for 0.5 seconds and no sound will be heard.
7. The breakdown diagnosis mode will be canceled by pressing the CHECK button continuously for 5 seconds or without any operation the remote control for 30 seconds.
8. The LED will be off if the unit is turned off or the RESET button on the main unit is pressed.

• To display memorized error (Protective operation) status:

1. Turn power on.
2. Press the CHECK button on the remote controller continuously for 5 seconds.
3. “- -” will be displayed on the remote controller display.
Note: Display only for “- -”. (No transmitting signal, no receiving sound and no Power LED blinking.)
4. Press the “TIMER” ▲ or ▼ button on the remote controller. The code “H00” (no abnormality) will be displayed and signal will be transmitted to the main unit. The power LED lights up. If no abnormality is stored in the memory, three beeps sound will be heard.
5. Every press of the button (up or down) will increase abnormality numbers and transmit abnormality code signal to the main unit.
6. When the latest abnormality code on the main unit and code transmitted from the remote controller are matched, power LED will light up for 30 seconds and a beep sound (continuously for 4 seconds) will be heard. If no codes are matched, power LED will light up for 0.5 seconds and no sound will be heard.

7. The breakdown diagnosis mode will be canceled unless pressing the CHECK button continuously for 5 seconds or operating the unit for 30 seconds.
8. The same diagnosis can be repeated by turning power on again.

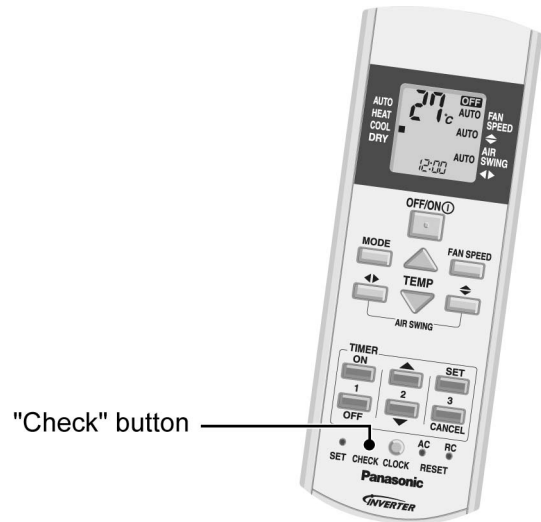

• To clear memorized error (Protective operation) status after repair:

1. Turn power on.
2. Press the AUTO button for 5 seconds (A beep receiving sound) on the main unit to operate the unit at Forced Cooling Operation mode.
3. Press the CHECK button on the remote controller for about 1 second with a pointed object to transmit signal to main unit. A beep sound is heard from main unit and the data is cleared.

• Temporary Operation (Depending on breakdown status)

1. Press the AUTO button (A beep receiving sound) on the main unit to operate the unit. (Remote control will become possible.)
2. The unit can temporarily be used until repaired.

Error Code	Operation	Temporary items
H23	Cooling	Emergency Operation with limited power
H27, H28	Cooling, Heating	Emergency Operation with limited power
H26	Cooling, Heating	Emergency Operation with limited power

15.4. Error Codes Table

Diagnosis display	Abnormality / Protection control	Abnormality Judgement	Emergency operation	Primary location to verify
H00	No abnormality detected	—	Normal operation	—
H11	Indoor / outdoor abnormal communication	> 1 min after starting operation	Indoor fan operation only	<ul style="list-style-type: none"> • Internal / external cable connections • Indoor / Outdoor PCB
H12	Connection capability rank abnormal	—	—	—
H14	Indoor intake air temperature sensor abnormality	Continue for 5 sec.	—	<ul style="list-style-type: none"> • Intake air temperature sensor (defective or disconnected)
H15	Outdoor compressor temperature sensor abnormality	Continue for 5 sec.	—	<ul style="list-style-type: none"> • Compressor temperature sensor (defective or disconnected)
H16	Outdoor Current Transformer open circuit	—	—	<ul style="list-style-type: none"> • Outdoor PCB • IPM (Power transistor) module
H19	Indoor fan motor mechanism lock	—	—	<ul style="list-style-type: none"> • Indoor PCB • Fan motor
H23	Indoor heat exchanger temperature sensor abnormality	Continue for 5 sec.	O (Cooling only)	<ul style="list-style-type: none"> • Heat exchanger temperature sensor (defective or disconnected)
H27	Outdoor air temperature sensor abnormality	Continue for 5 sec.	O	<ul style="list-style-type: none"> • Outdoor temperature sensor (defective or disconnected)
H28	Outdoor heat exchanger temperature sensor abnormality	Continue for 5 sec.	O	<ul style="list-style-type: none"> • Outdoor heat exchanger temperature sensor (defective or disconnected)
H30	Discharge temperature sensor abnormality	Continue for 5 sec.	—	<ul style="list-style-type: none"> • Discharge temperature sensor
H33	Indoor/Outdoor wrong connection	—	—	<ul style="list-style-type: none"> • Indoor/Outdoor supply voltage
H38	Indoor/Outdoor mismatch (brand code)	—	—	—
H97	Outdoor Fan Motor lock abnormality	—	—	<ul style="list-style-type: none"> • Outdoor PCB • Outdoor Fan Motor
H98	Indoor high pressure protection	—	—	<ul style="list-style-type: none"> • Air filter dirty • Air circulation short circuit
H99	Indoor heat exchanger anti-freezing protection	—	—	<ul style="list-style-type: none"> • Insufficient refrigerant • Air filter dirty
F11	Cooling / Heating cycle changeover abnormality	4 times occurrence within 30 minutes	—	<ul style="list-style-type: none"> • 4-way valve • V-coil
F90	PFC control	4 times occurrence within 10 minutes	—	<ul style="list-style-type: none"> • Voltage at PFC
F91	Refrigeration cycle abnormality	7 times occurrence continuously	—	<ul style="list-style-type: none"> • No refrigerant (3-way valve is closed)
F93	Outdoor compressor abnormal revolution	4 times occurrence within 20 minutes	—	<ul style="list-style-type: none"> • Outdoor compressor
F95	Cool high pressure protection	4 times occurrence within 20 minutes	—	<ul style="list-style-type: none"> • Outdoor refrigerant circuit
F96	IPM (power transistor) overheating protection	—	—	<ul style="list-style-type: none"> • Excess refrigerant • Improper heat radiation • IPM (Power transistor)
F97	Outdoor compressor overheating protection	4 times occurrence within 20 minutes	—	<ul style="list-style-type: none"> • Insufficient refrigerant • Compressor
F98	Total running current protection	3 times occurrence within 20 minutes	—	<ul style="list-style-type: none"> • Excess refrigerant • Improper heat radiation
F99	Outdoor Direct Current (DC) peak detection	7 times occurrence continuously	—	<ul style="list-style-type: none"> • Outdoor PCB • IPM (Power transistor) • Compressor

Note:

“O” - Frequency measured and fan speed fixed.

The memory data of error code is erased when the power supply is cut off, or press the Auto Switch until “beep” sound heard following by pressing the “CHECK” button at Remote Control.

Although operation forced to stop when abnormality detected, emergency operation is possible for certain errors (refer to Error Codes Table) by using Remote Control or Auto Switch at indoor unit. However, the Remote Control signal receiving sound is changed from one “beep” to four “beep” sounds.

15.5. Self-diagnosis Method

15.5.1. H11 (Indoor/Outdoor Abnormal Communication)

Malfunction Decision Conditions

- During startup and operation of cooling and heating, the data received from outdoor unit in indoor unit signal transmission is checked whether it is normal.

Malfunction Caused

- Faulty indoor unit PCB.
- Faulty outdoor unit PCB.
- Indoor unit-outdoor unit signal transmission error due to wrong wiring.
- Indoor unit-outdoor unit signal transmission error due to breaking of wire in the connection wires between the indoor and outdoor units.
- Indoor unit-outdoor unit signal transmission error due to disturbed power supply waveform.

Troubleshooting

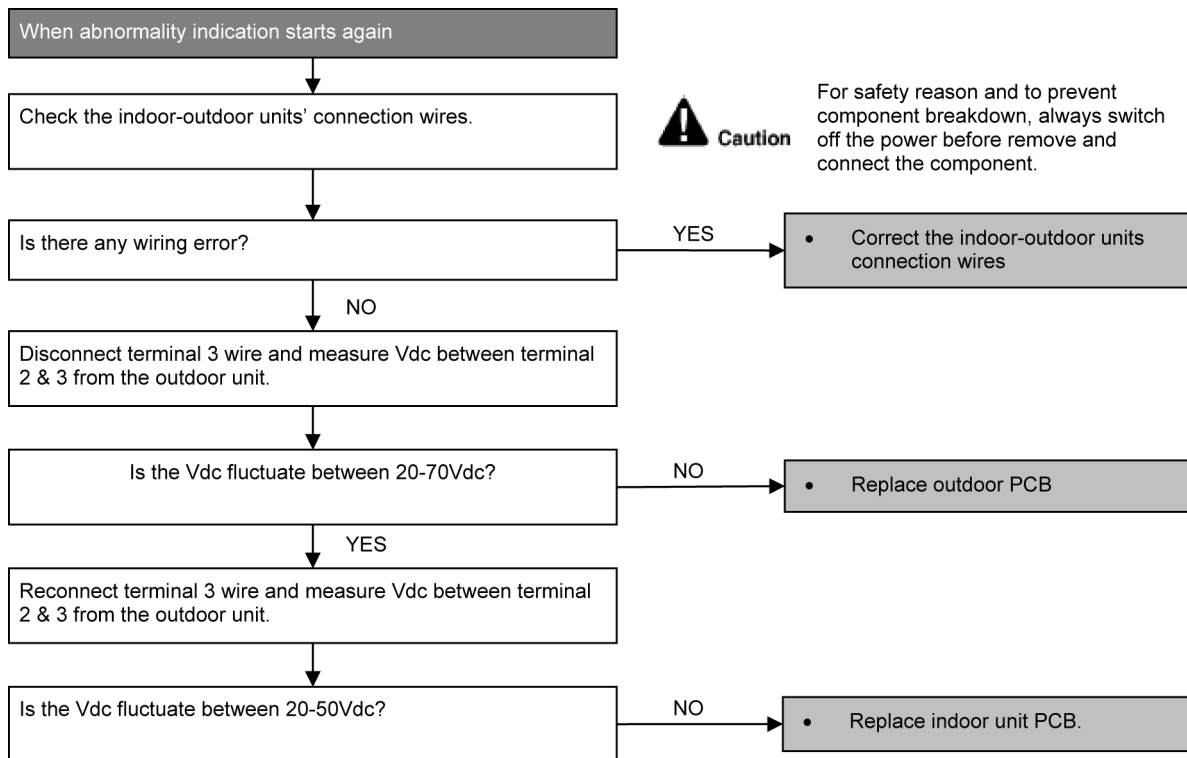

15.5.2. H12 (Indoor/Outdoor Capacity Rank Mismatched)

Malfunction Decision Conditions

- During startup, error code appears when different types of indoor and outdoor units are interconnected.

Malfunction Caused

- Wrong models interconnected.
- Wrong indoor unit or outdoor unit PCBs mounted.
- Indoor unit or outdoor unit PCBs defective.
- Indoor-outdoor unit signal transmission error due to wrong wiring.
- Indoor-outdoor unit signal transmission error due to breaking of wire 3 in the connection wires between the indoor and outdoor units.

Troubleshooting

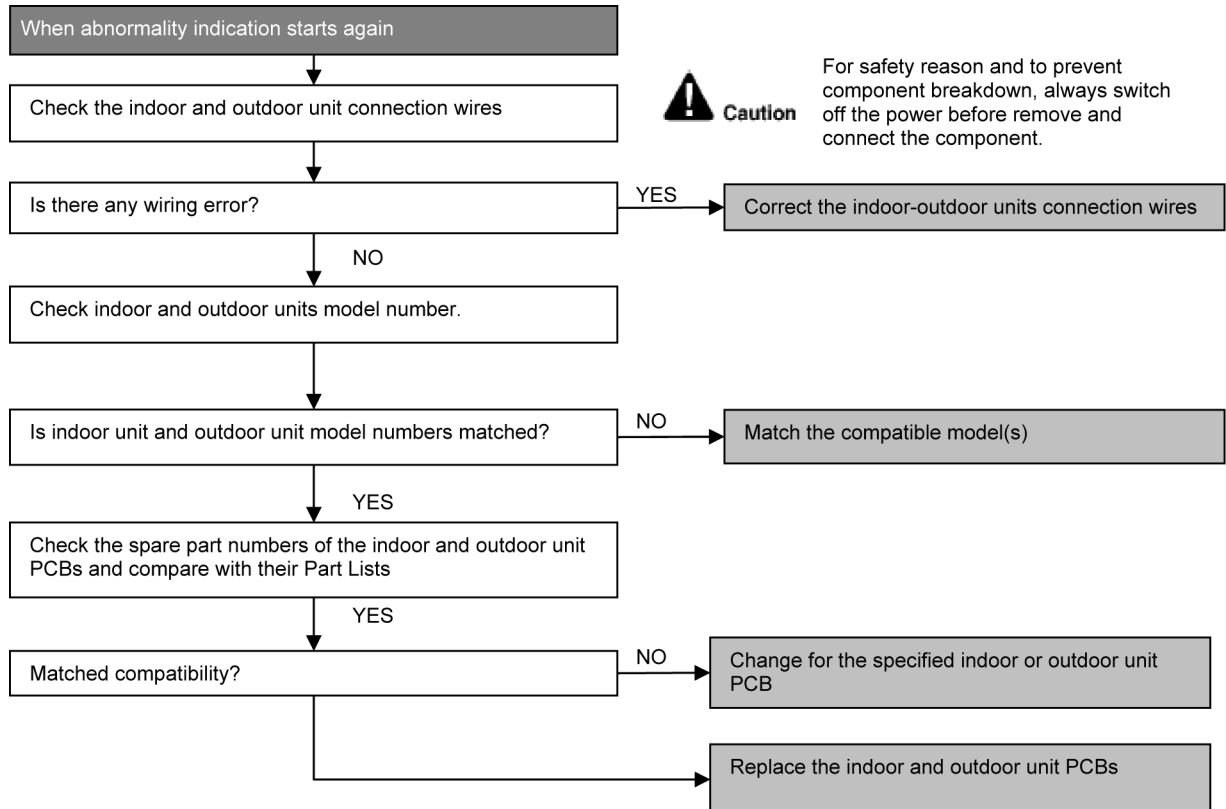

15.5.3. H14 (Indoor Intake Air Temperature Sensor Abnormality)

Malfunction Decision Conditions

- During startup and operation of cooling and heating, the temperatures detected by the indoor intake air temperature sensor are used to determine sensor errors.

Malfunction Caused

- Faulty connector connection.
- Faulty sensor.
- Faulty PCB.

Troubleshooting

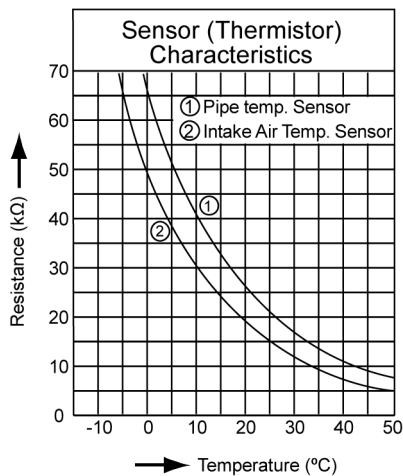
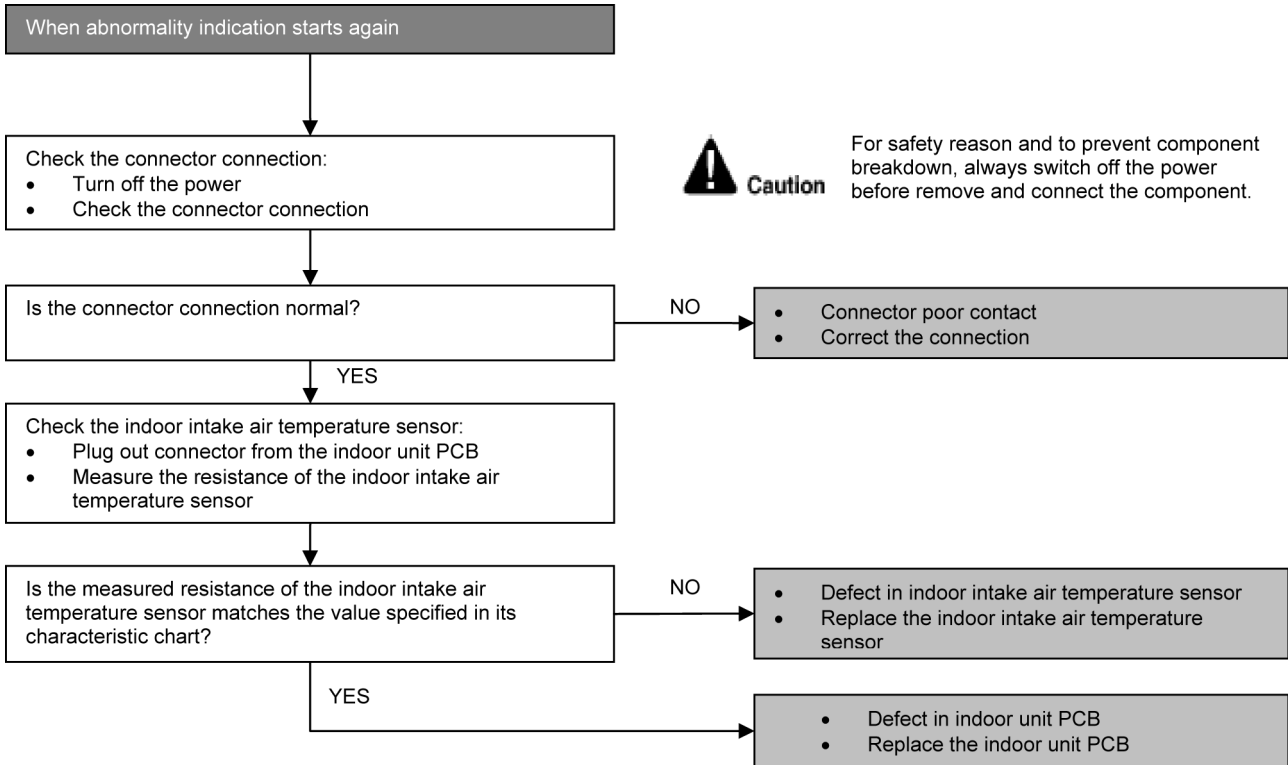

15.5.4. H15 (Compressor Temperature Sensor Abnormality)

Malfunction Decision Conditions

- During startup and operation of cooling and heating, the temperatures detected by the outdoor compressor temperature sensor are used to determine sensor errors.

Malfunction Caused

- Faulty connector connection.
- Faulty sensor.
- Faulty PCB.

Troubleshooting

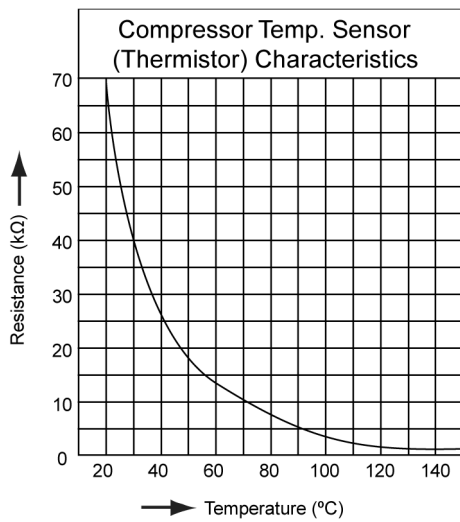
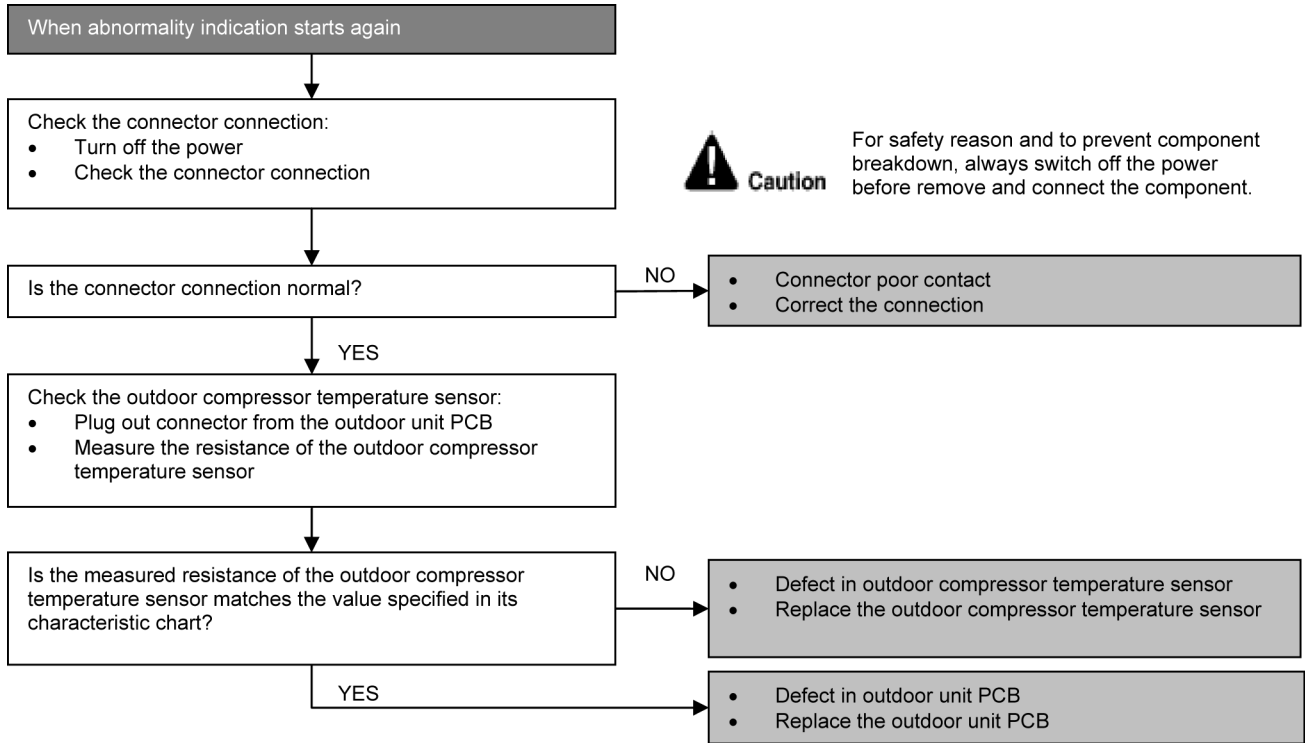

15.5.5. H16 (Outdoor Current Transformer Open Circuit)

Malfunction Decision Conditions

- A current transformer (CT) is detected by checking the compressor running frequency (\geq rated frequency) and CT detected input current (less than 0.65A) for continuously 20 seconds.

Malfunction Caused

- CT defective.
- Outdoor PCB defective.
- Compressor defective (low compression).

Troubleshooting

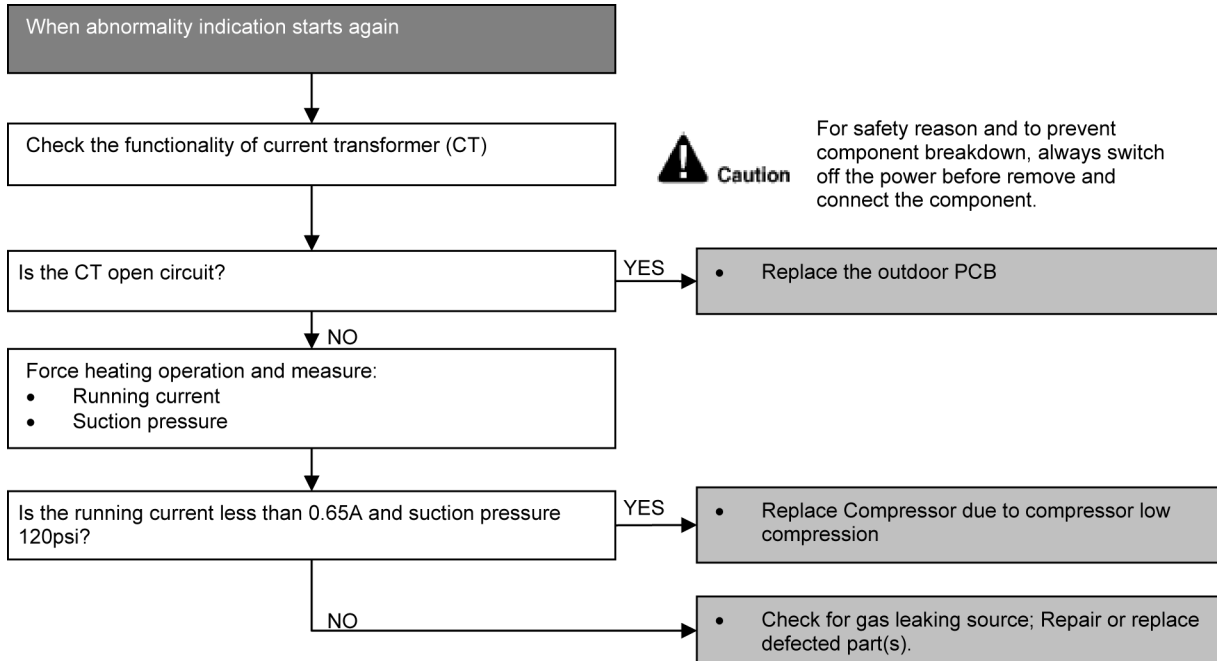

15.5.6. H19 (Indoor Fan Motor – DC Motor Mechanism Locked)

Malfunction Decision Conditions

- The rotation speed detected by the Hall IC during fan motor operation is used to determine abnormal fan motor (feedback of rotation > 2550rpm or < 50rpm).

Malfunction Caused

- Operation stops due to short circuit inside the fan motor winding.
- Operation stops due to breaking of wire inside the fan motor.
- Operation stops due to breaking of fan motor lead wires.
- Operation stops due to Hall IC malfunction.
- Operation error due to faulty indoor unit PCB.

Troubleshooting

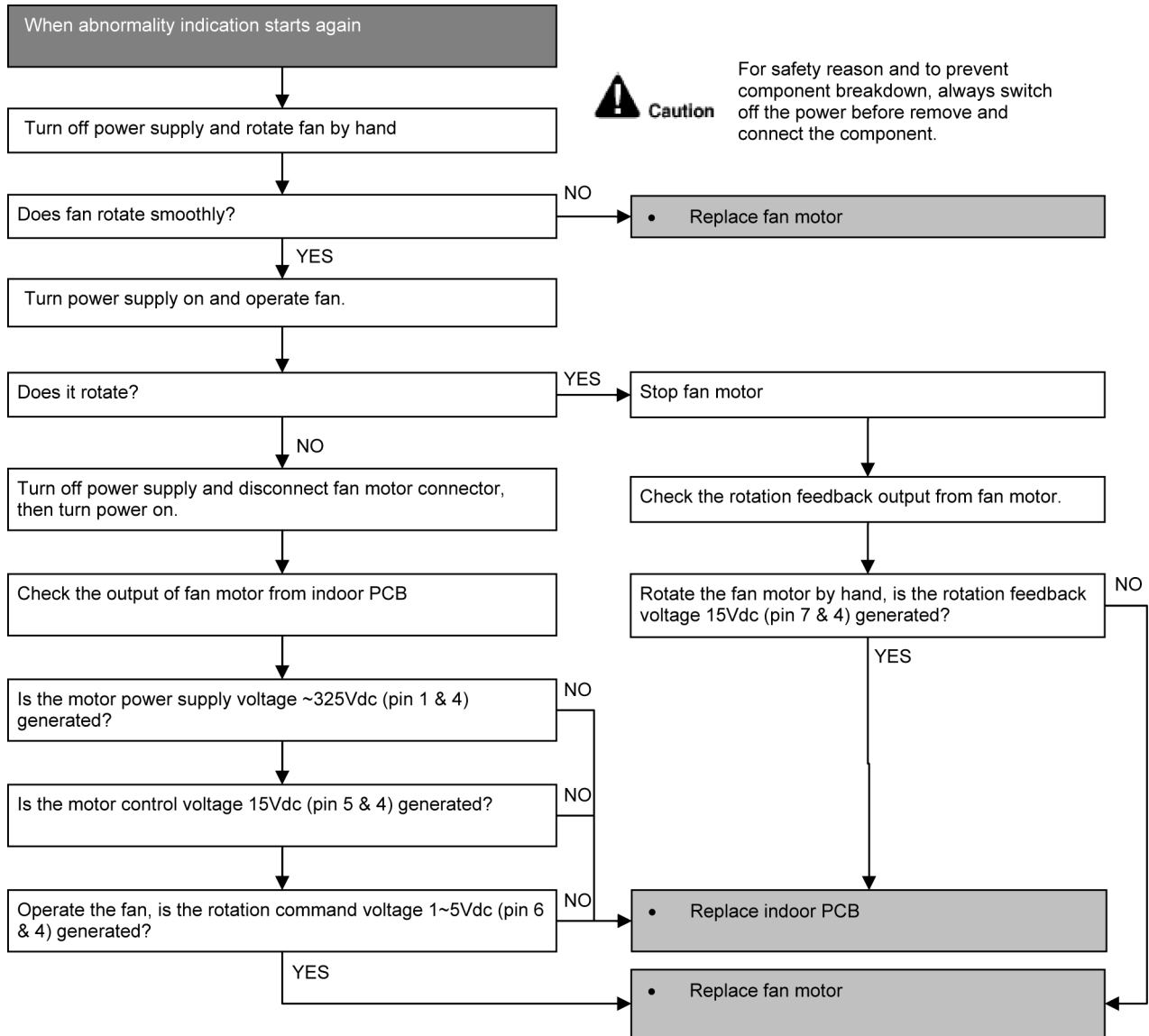

15.5.7. H23 (Indoor Pipe Temperature Sensor Abnormality)

Malfunction Decision Conditions

- During startup and operation of cooling and heating, the temperatures detected by the indoor heat exchanger temperature sensor are used to determine sensor errors.

Malfunction Caused

- Faulty connector connection.
- Faulty sensor.
- Faulty PCB.

Troubleshooting

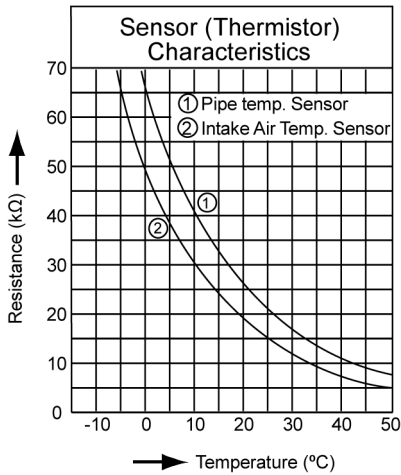
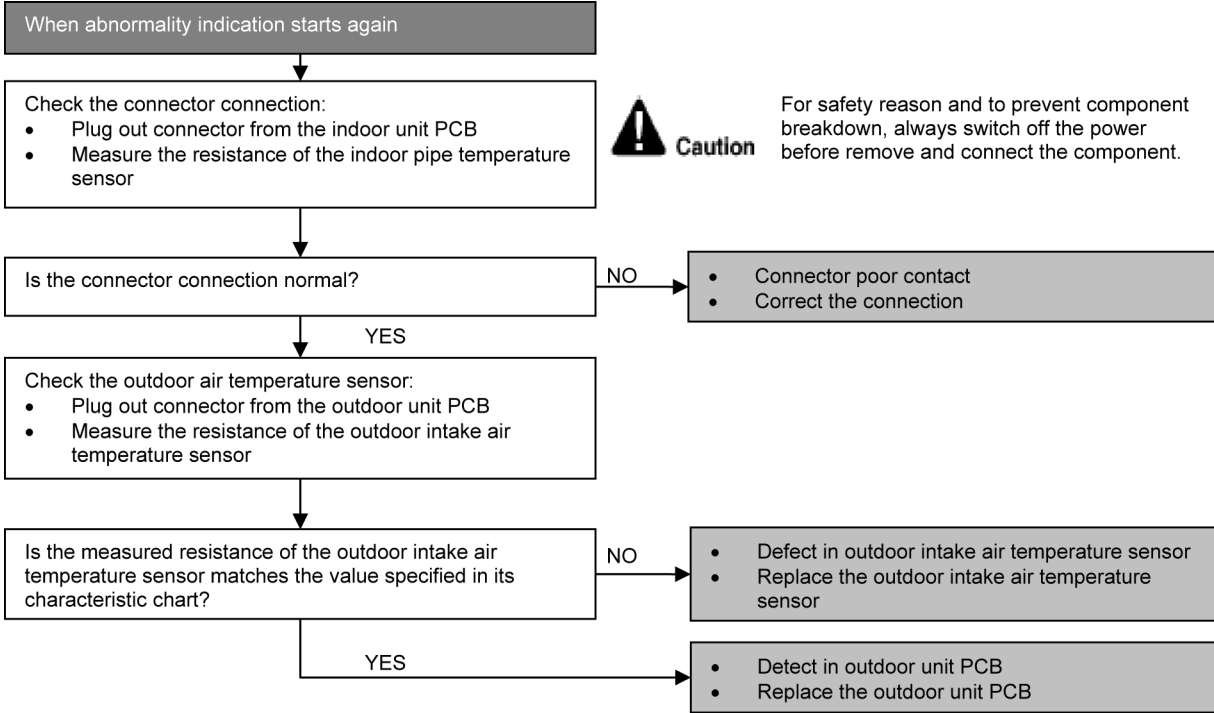

15.5.8. H27 (Outdoor Air Temperature Sensor Abnormality)

Malfunction Decision Conditions

- During startup and operation of cooling and heating, the temperatures detected by the outdoor air temperature sensor are used to determine sensor errors.

Malfunction Caused

- Faulty connector connection.
- Faulty sensor.
- Faulty PCB.

Troubleshooting

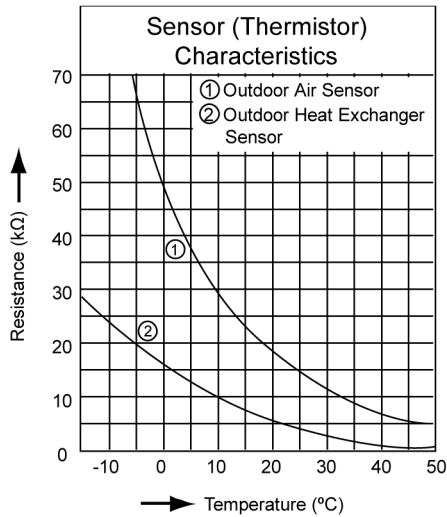
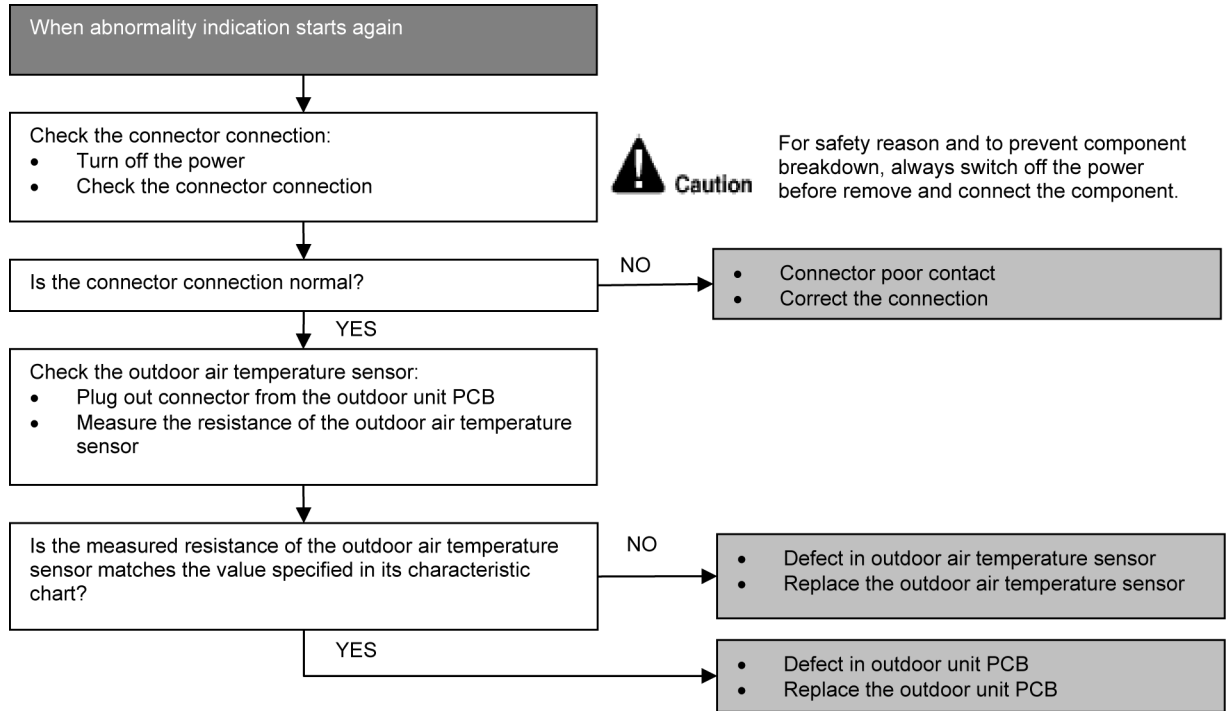

15.5.9. H28 (Outdoor Pipe Temperature Sensor Abnormality)

Malfunction Decision Conditions

- During startup and operation of cooling and heating, the temperatures detected by the outdoor pipe temperature sensor are used to determine sensor errors.

Malfunction Caused

- Faulty connector connection.
- Faulty sensor.
- Faulty PCB.

Troubleshooting

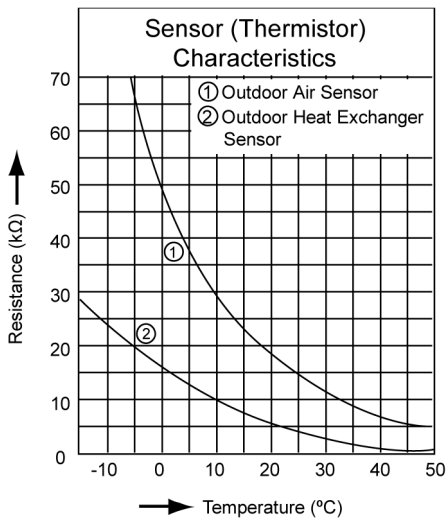
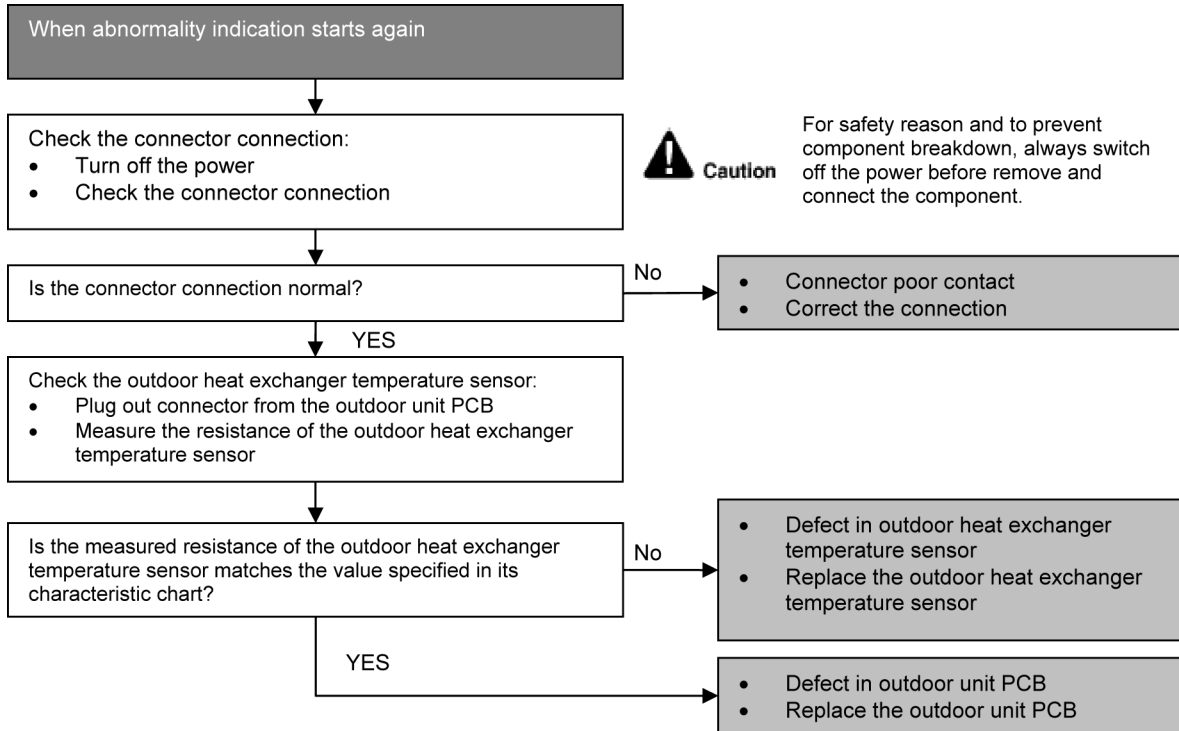

15.5.10. H30 (Compressor Discharge Temperature Sensor Abnormality)

Malfunction Decision Conditions

- During startup and operation of cooling and heating, the temperatures detected by the outdoor discharge pipe temperature sensor are used to determine sensor errors.

Malfunction Caused

- Faulty connector connection.
- Faulty sensor.
- Faulty PCB.

Troubleshooting

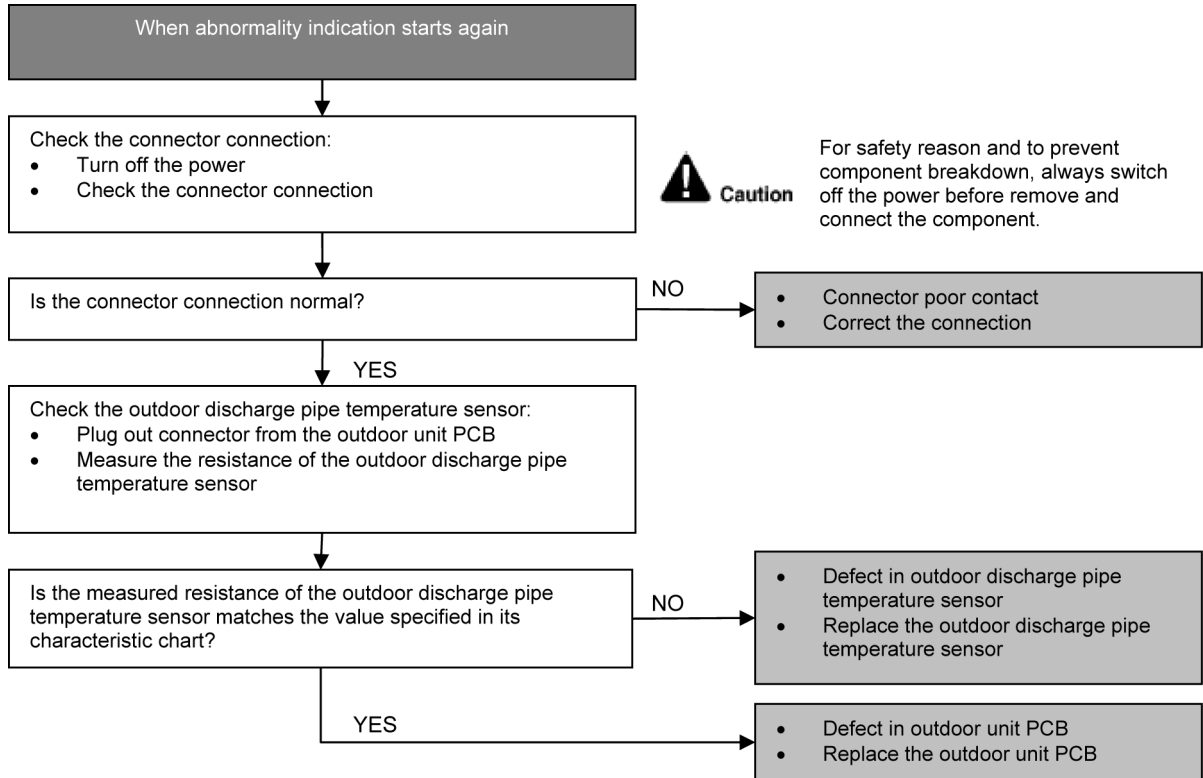

15.5.11. H33 (Unspecified Voltage between Indoor and Outdoor)

Malfunction Decision Conditions

- The supply power is detected for its requirement by the indoor/outdoor transmission.

Malfunction Caused

- Wrong models interconnected.
- Wrong indoor unit and outdoor unit PCBs used.
- Indoor unit or outdoor unit PCB defective.

Troubleshooting

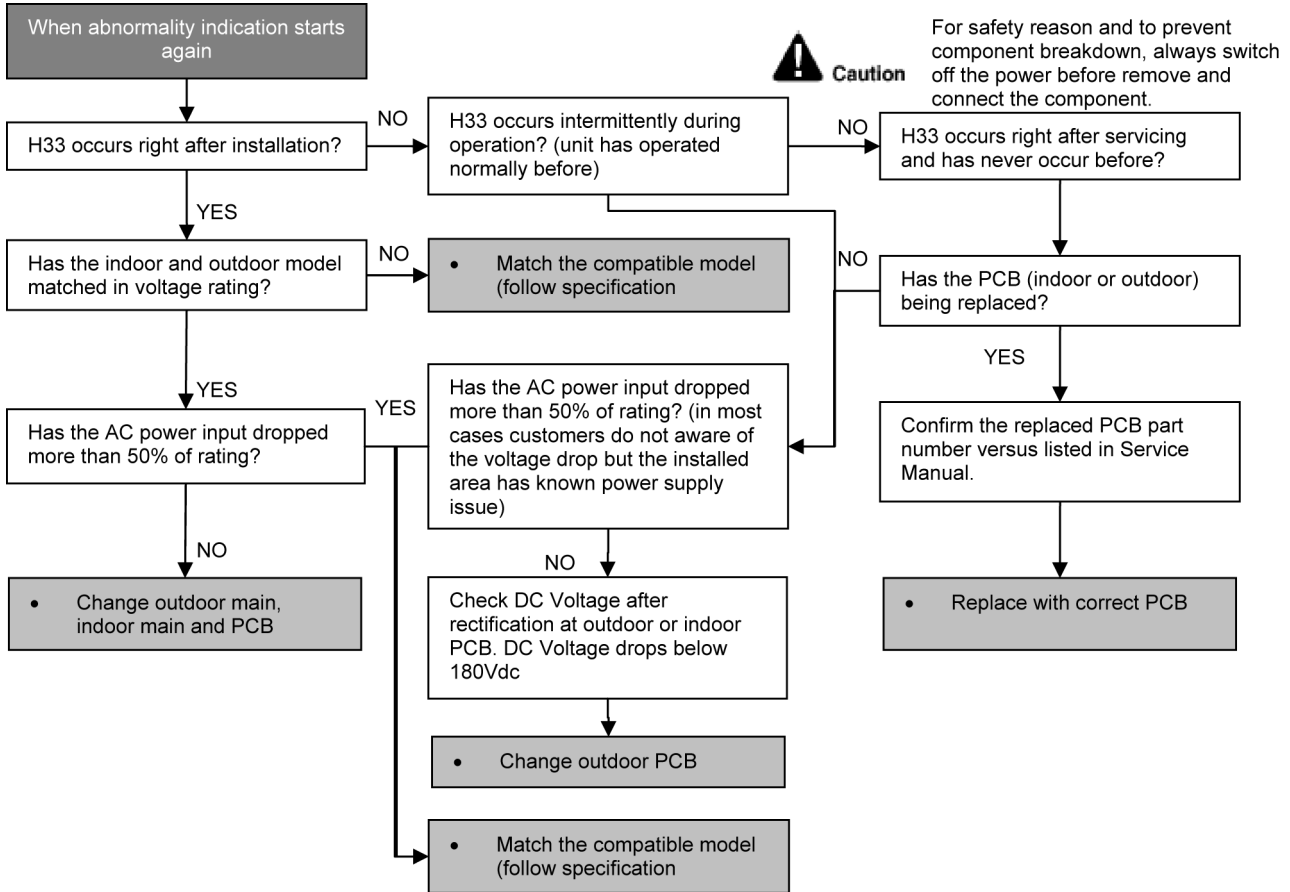

15.5.12. H58 (Patrol Sensor Abnormality)

Malfunction Decision Conditions

- If Patrol sensor feedback is 0V or 5V continuous for 6 hours.
- Error will display only when the Patrol operation is ON.

Malfunction Caused

- Faulty connector connection.
- Faulty Patrol sensor.

Troubleshooting

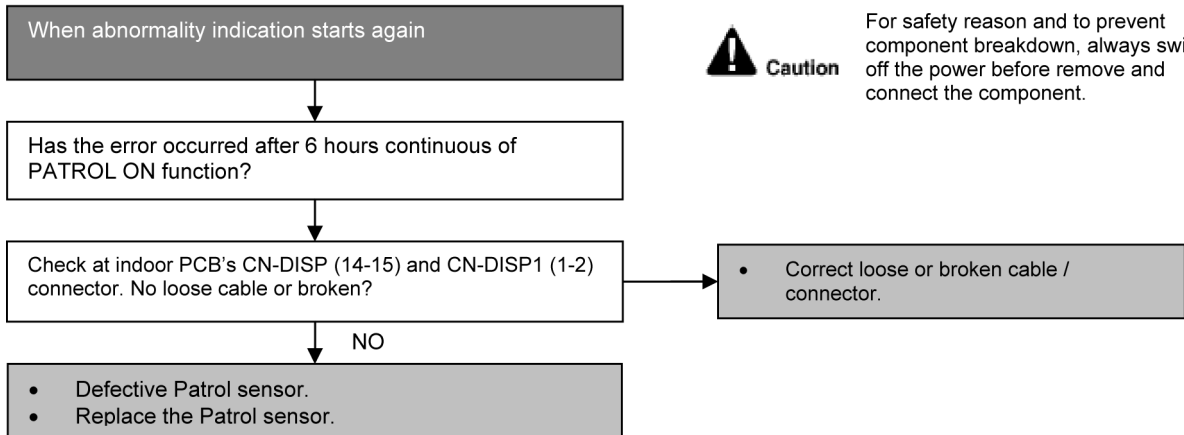

15.5.13. H97 (Outdoor Fan Motor – DC Motor Mechanism Locked)

Malfunction Decision Conditions

- The rotation speed detected by the Hall IC during fan motor operation is used to determine abnormal fan motor.

Malfunction Caused

- Operation stops due to short circuit inside the fan motor winding.
- Operation stops due to breaking of wire inside the fan motor.
- Operation stops due to breaking of fan motor lead wires.
- Operation stops due to Hall IC malfunction.
- Operation error due to faulty outdoor unit PCB.

Troubleshooting

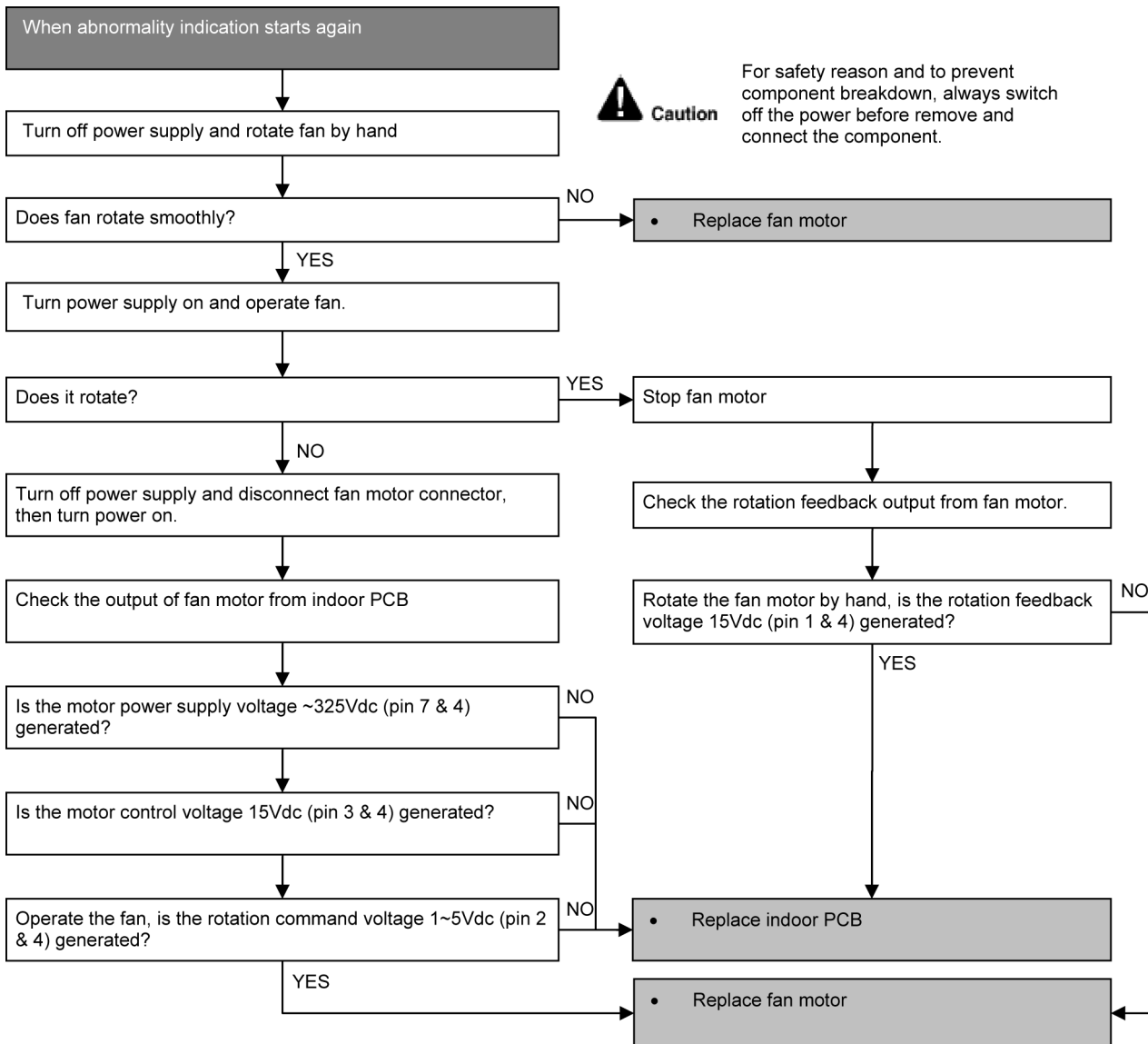

15.5.14. H98 (Indoor High Pressure Protection)

Error Code will not display (no Timer LED blinking) but store in EEPROM

Malfunction Decision Conditions

- During heating operation, the temperature detected by the indoor pipe temperature sensor is above 60°C.

Malfunction Caused

- Clogged air filter of the indoor unit.
- Dust accumulation on the indoor unit heat exchanger.
- Air short circuit.
- Detection error due to faulty indoor pipe temperature sensor.
- Detection error due to faulty indoor unit PCB.

Troubleshooting

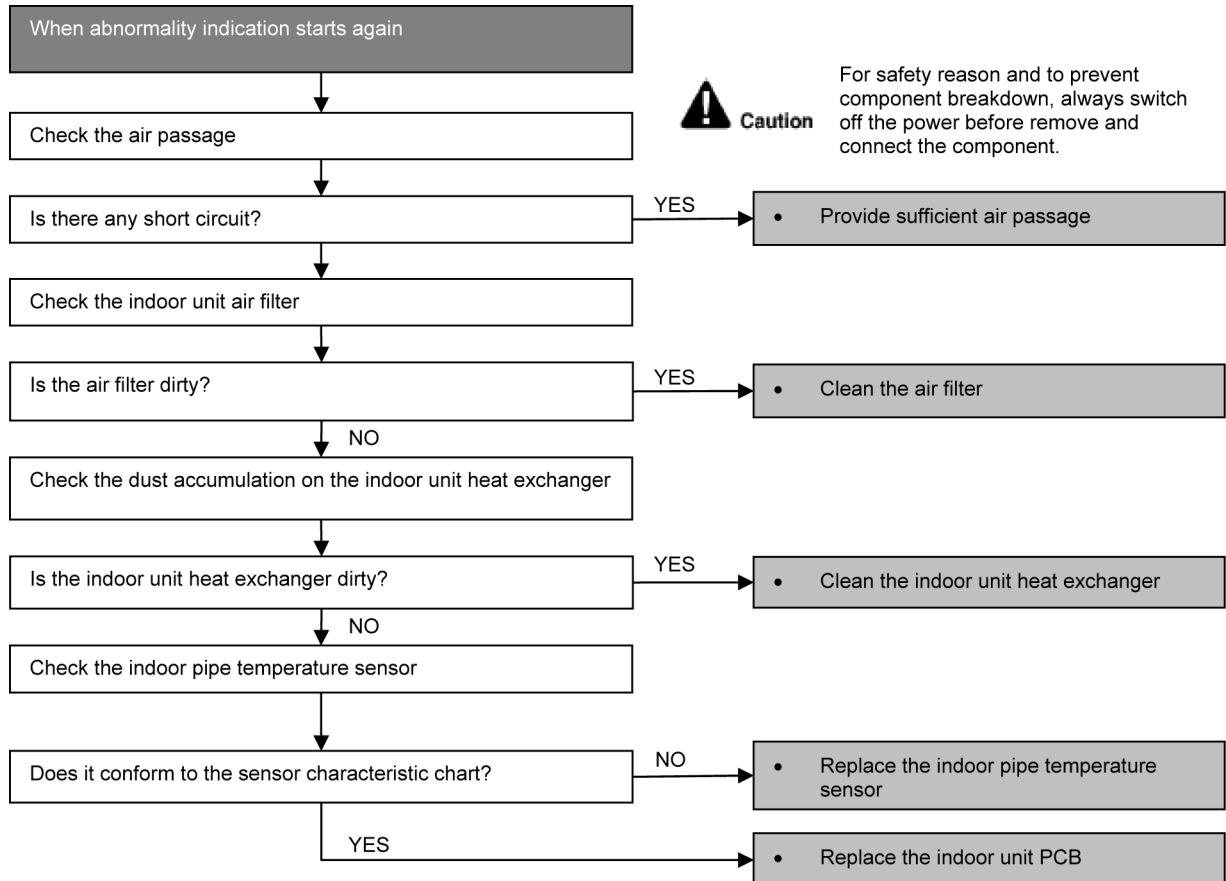

15.5.15. H99 (Indoor Freeze Prevention Protection: Cooling or Soft Dry)

Error code will not display (no TIMER LED blinking) but store in EEPROM

Malfunction Decision Conditions

- Freeze prevention control takes place (when indoor pipe temperature is lower than 2°C).

Malfunction Caused

- Clogged air filter of the indoor unit.
- Dust accumulation on the indoor unit heat exchanger.
- Air short circuit.
- Detection error due to faulty indoor pipe temperature sensor.
- Detection error due to faulty indoor unit PCB.

Troubleshooting

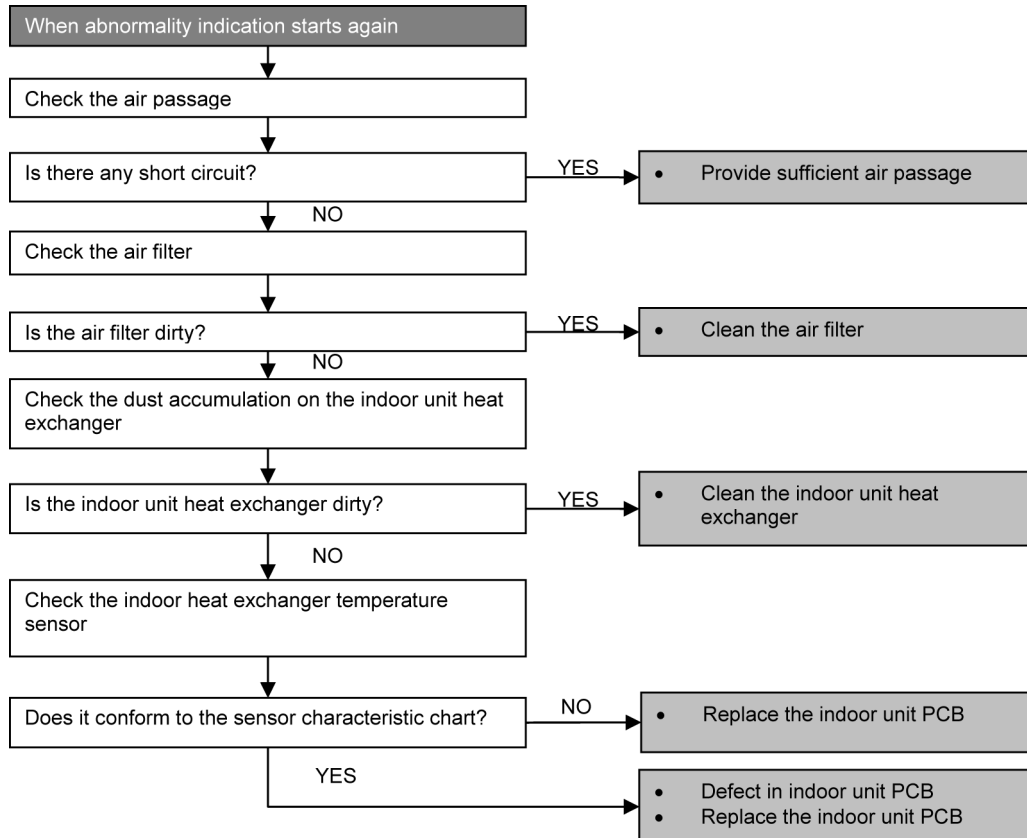

15.5.16. F11 (4-way valve Abnormality)

Malfunction Decision Conditions

- When heating operation, when indoor pipe temperature is below 10°C.
- When cooling operation, when indoor pipe temperature is above 45°C.

Malfunction Caused

- Connector in poor contact.
- Faulty sensor.
- Faulty outdoor unit PCB.
- 4-way valve defective.

Troubleshooting

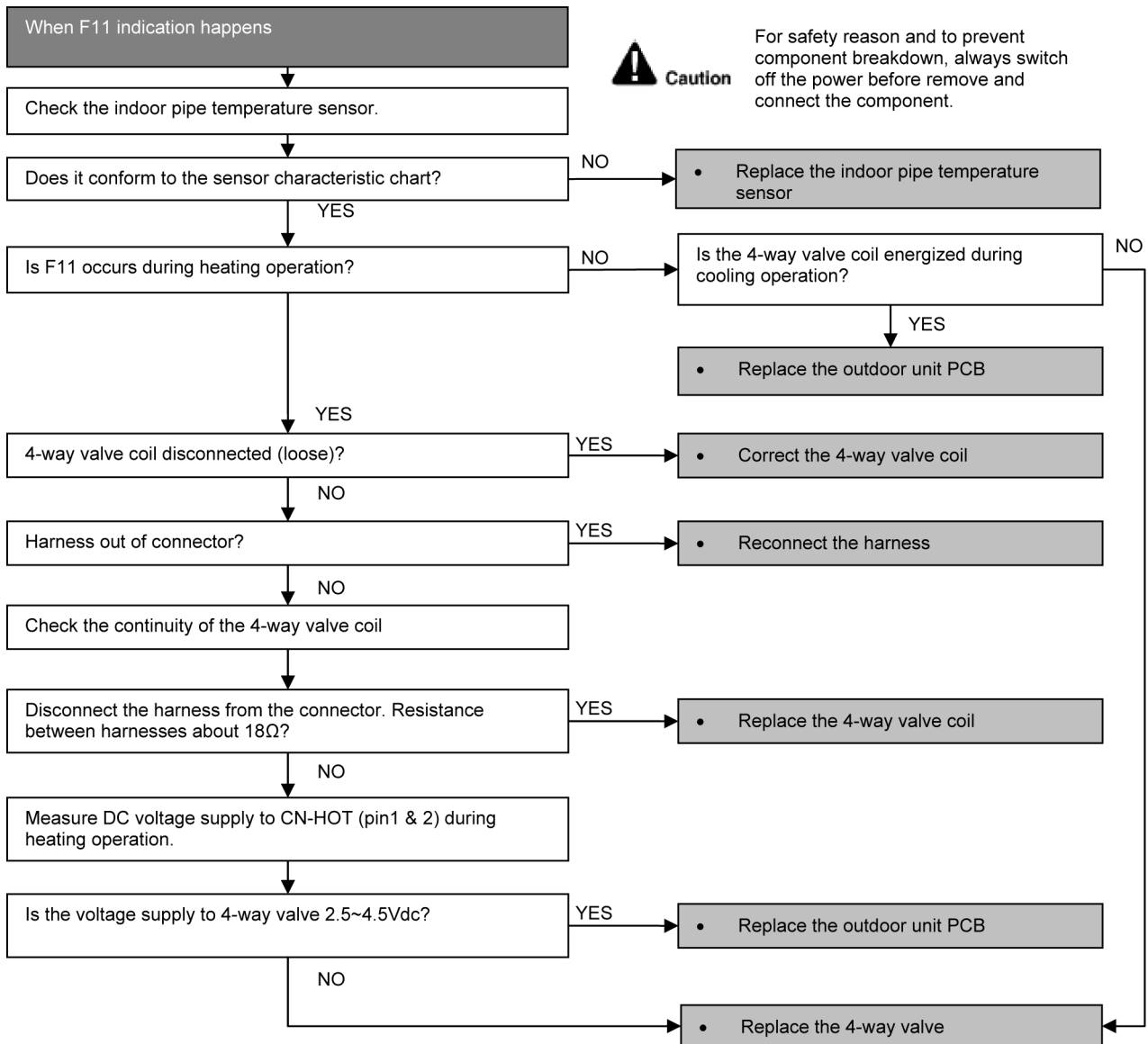

15.5.17. F90 (Power Factor Correction Protection)

Malfunction Decision Conditions

- During startup and operation of cooling and heating, when Power Factor Correction (PFC) protection circuitry at the outdoor unit main PCB senses abnormal high DC voltage level.

Malfunction Caused

- DC voltage peak due to power supply surge.
- DC voltage peak due to compressor windings not uniform.
- Faulty outdoor PCB.

Troubleshooting

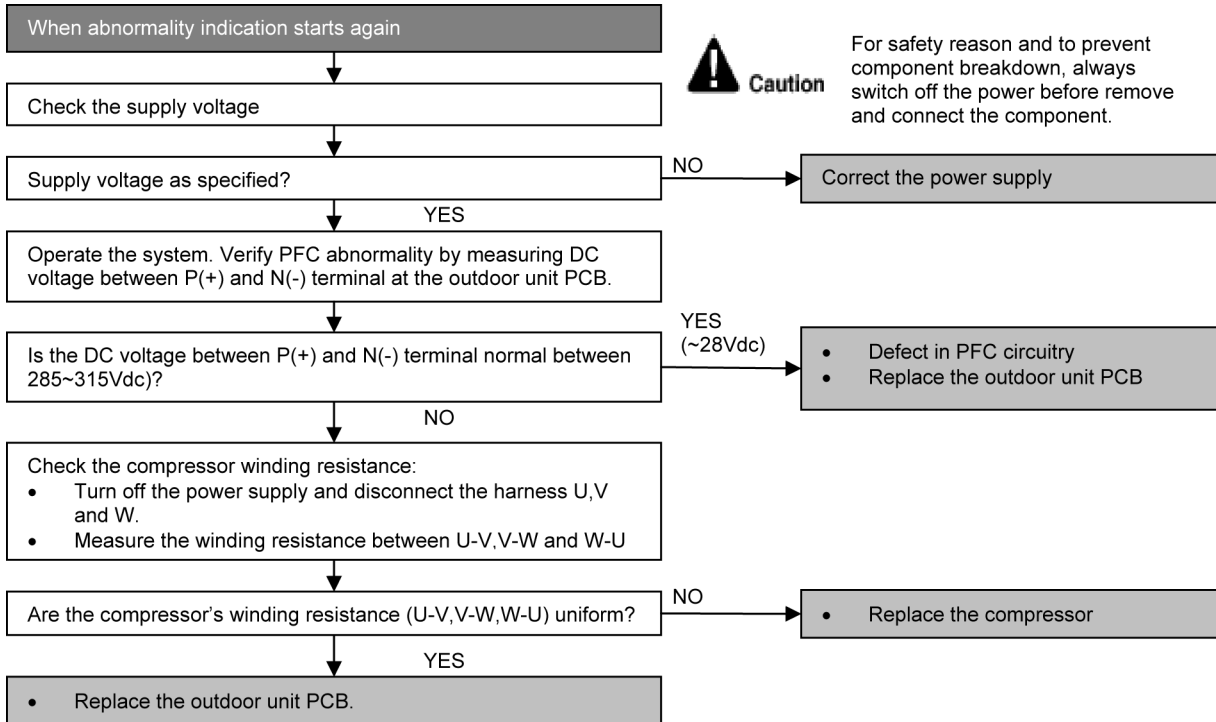

15.5.18. F91 (Refrigeration Cycle Abnormality)

Malfunction Decision Conditions

- During cooling, compressor frequency = F_{cmax}.
- During heating, compressor frequency > F_{hrated}.
- During cooling and heating operation, running current: 0.65A < I < 1.65A.
- During cooling, indoor intake - indoor pipe < 4°C.
- During heating, indoor pipe - indoor intake < 5°C.

Multi Models Only

- Gas shortage detection 1: A gas shortage is detected by checking the CT-detected input current value and the compressor running frequency. During startup and operating of cooling and heating, input current < 8.78/256 (A/Hz) × compressor running frequency + 0.25.
- Gas shortage detection 2: A gas shortage is detected by checking the difference between indoor pipe temperature and indoor intake air temperature during cooling and heating.

Malfunction Caused

- Refrigerant shortage (refrigerant leakage).
- Poor compression performance of compressor.
- 2/3 way valve closed.
- Detection error due to faulty indoor intake air or indoor pipe temperature sensors.

Troubleshooting

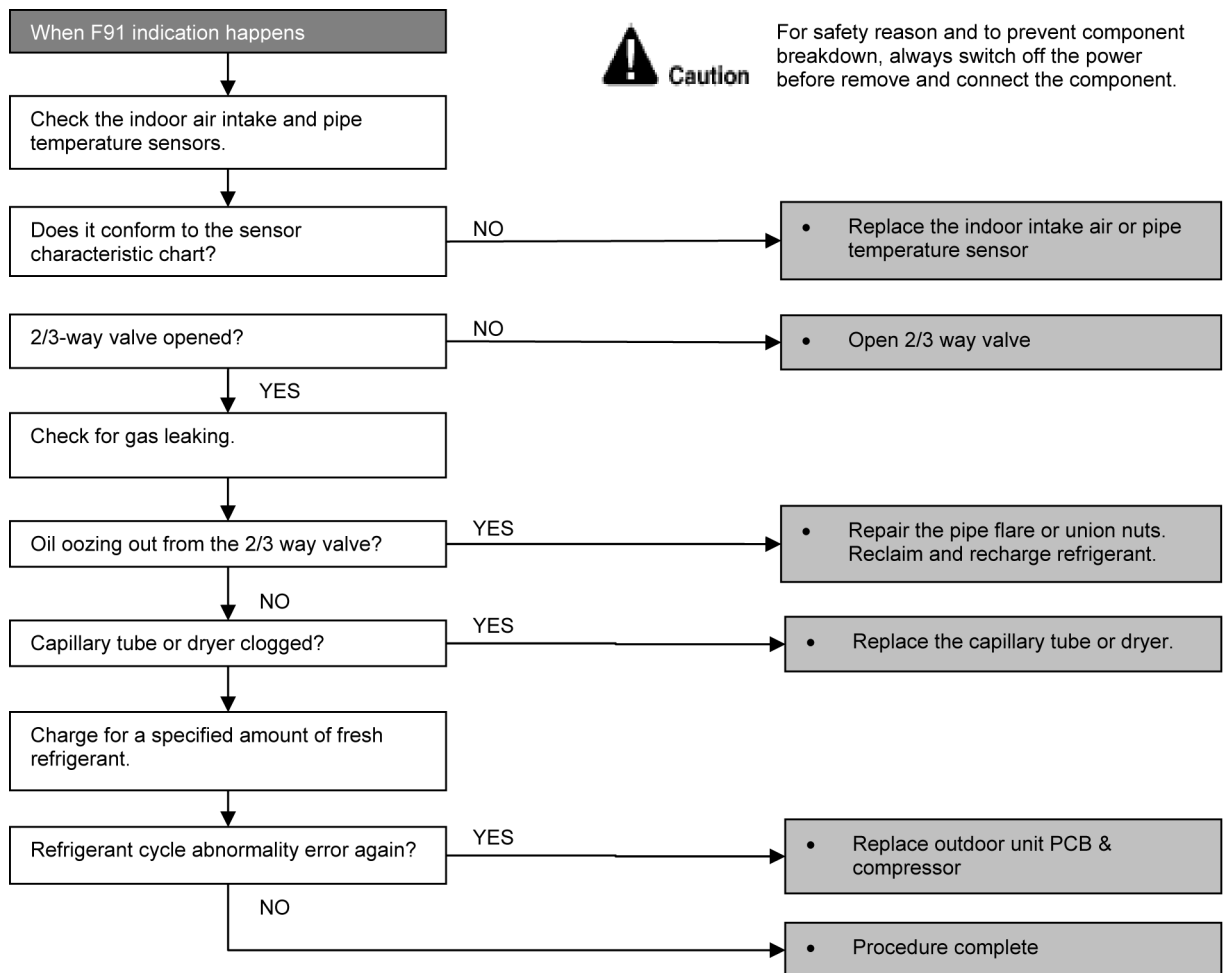

15.5.19. F93 (Compressor Rotation Failure)

Malfunction Decision Conditions

A compressor rotation failure is detected by checking the compressor running condition through the position detection circuit.

Malfunction Caused

- Compressor terminal disconnect.
- Outdoor PCB malfunction.

Troubleshooting

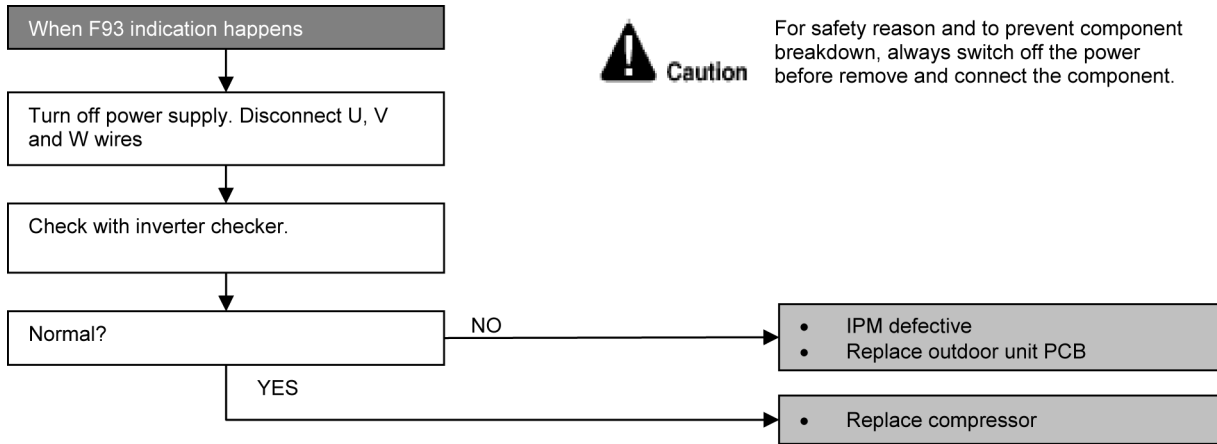

15.5.20. F95 (Cooling High Pressure Abnormality)

Malfunction Decision Conditions

During operation of cooling, when outdoor unit heat exchanger high temperature data (61°C) is detected by the outdoor pipe temperature sensor.

Malfunction Caused

- Outdoor pipe temperature rise due to short circuit of hot discharge air flow.
- Outdoor pipe temperature rise due to defective of outdoor fan motor.
- Outdoor pipe temperature rise due to defective outdoor pipe temperature sensor.
- Outdoor pipe temperature rise due to defective outdoor unit PCB.

Troubleshooting

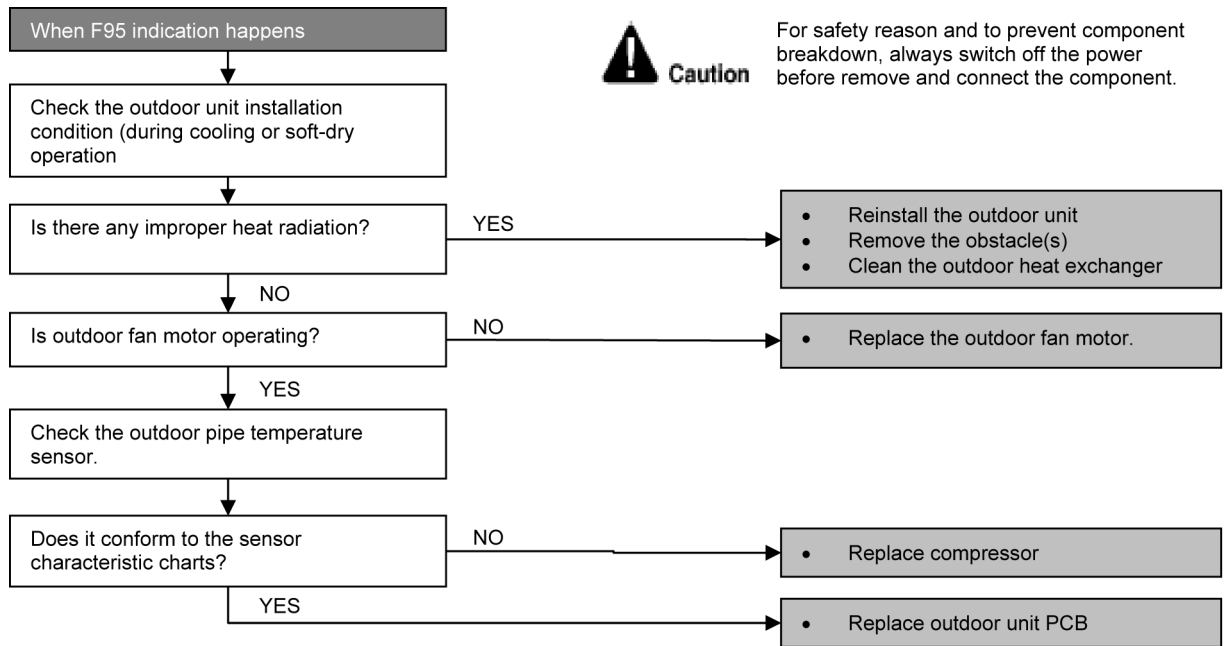

15.5.21. F96 (IPM Overheating)

Malfunction Decision Conditions

During operating of cooling and heating, when IPM temperature data (100°C) is detected by the IPM temperature sensor.

Multi Models Only

- Compressor Overheating: During operation of cooling and heating, when the compressor OL is activated.
- Heat Sink Overheating: During operation of cooling and heating, when heat sink temperature data (90°C) is detected by the heat sink temperature sensor.

Malfunction Caused

- IPM overheats due to short circuit of hot discharge air flow.
- IPM overheats due to defective of outdoor fan motor.
- IPM overheats due to defective of internal circuitry of IPM.
- IPM overheats due to defective IPM temperature sensor.

Multi Models Only

- Compressor OL connector poor contact.
- Compressor OL faulty.

Troubleshooting

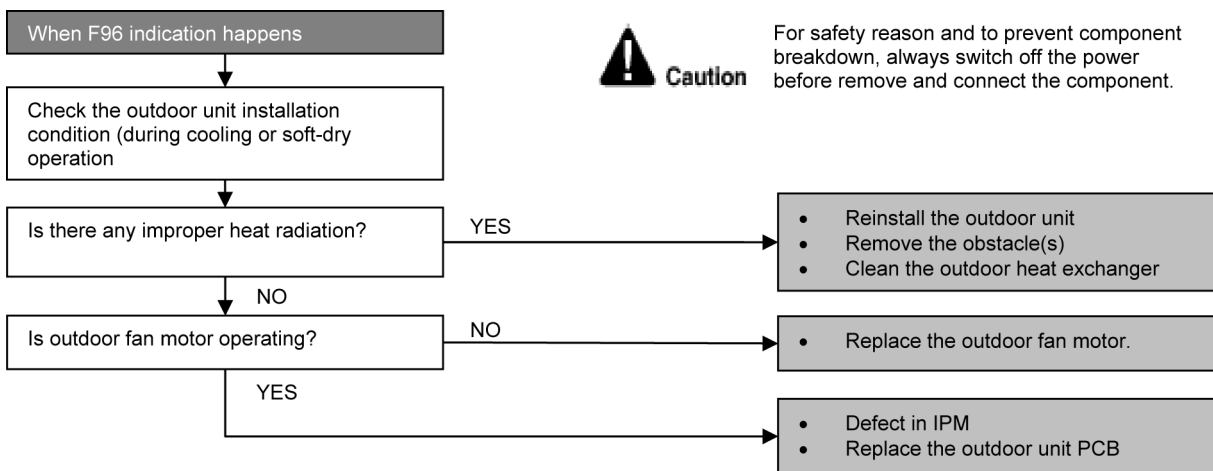

15.5.22. F97 (Compressor Overheating)

Malfunction Decision Conditions

During operation of cooling and heating, when compressor tank temperature data (112°C) is detected by the compressor tank temperature sensor.

Malfunction Caused

- Refrigerant shortage (refrigerant leakage).
- 2/3 way valve closed.
- Detection error due to faulty compressor tank temperature sensor.

Troubleshooting

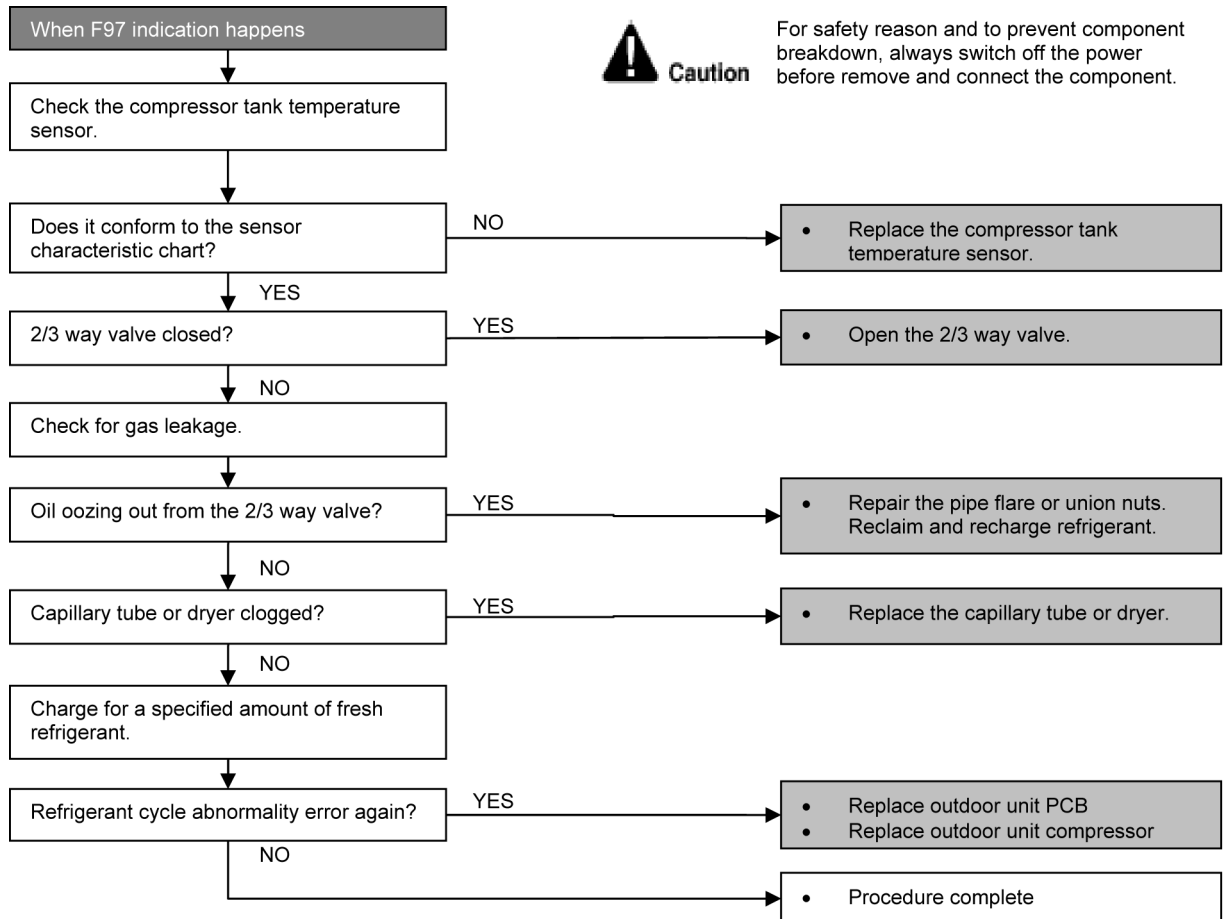

15.5.23. F98 (Input Over Current Detection)

Malfunction Decision Conditions

During operation of cooling and heating, when an input over-current (16.8A) is detected by checking the input current value being detected by current transformer (CT) with the compressor running.

Malfunction Caused

- Over-current due to compressor failure.
- Over-current due to defective outdoor unit PCB.
- Over-current due to defective inverter main circuit electrolytic capacitor.
- Over-current due to excessive refrigerant.

Troubleshooting

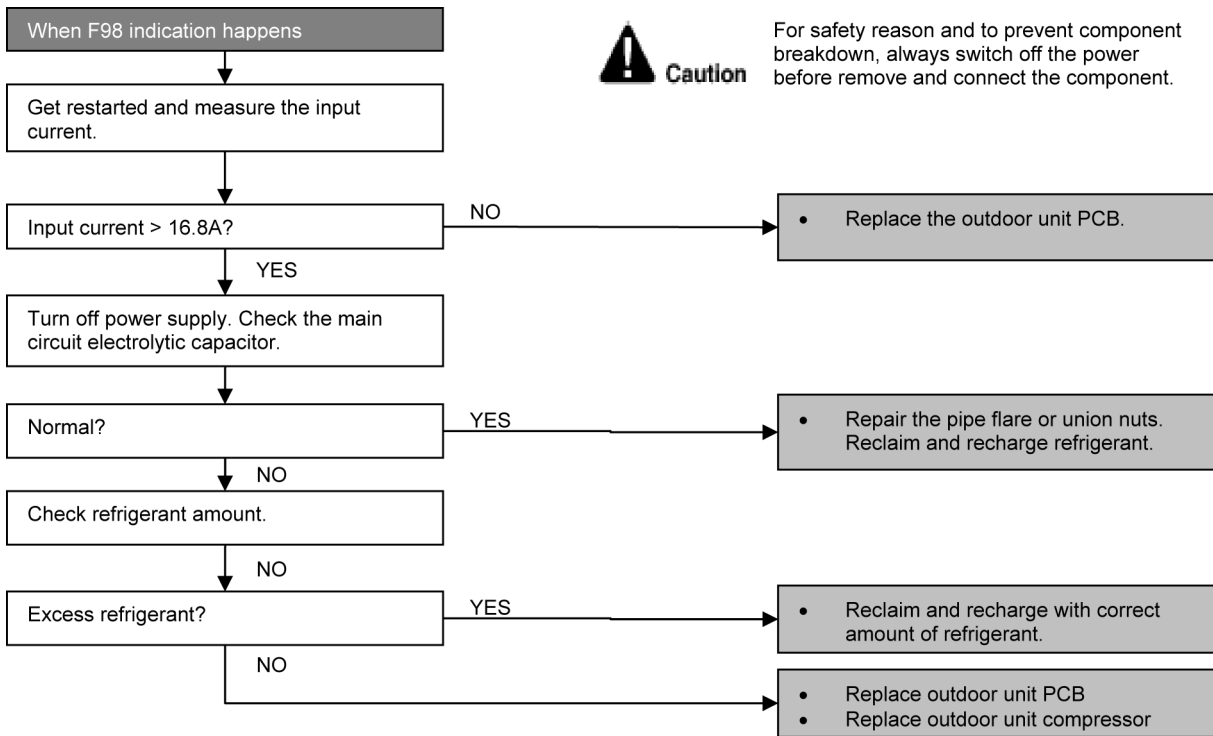

15.5.24. F99 (Output Over Current Detection)

Malfunction Decision Conditions

During operation of cooling and heating, when an output over-current (18.5A) is detected by checking the current that flows in the inverter DC peak sensing circuitry.

Malfunction Caused

- DC peak due to compressor failure.
- DC peak due to defective power transistor(s).
- DC peak due to defective outdoor unit PCB.

Troubleshooting

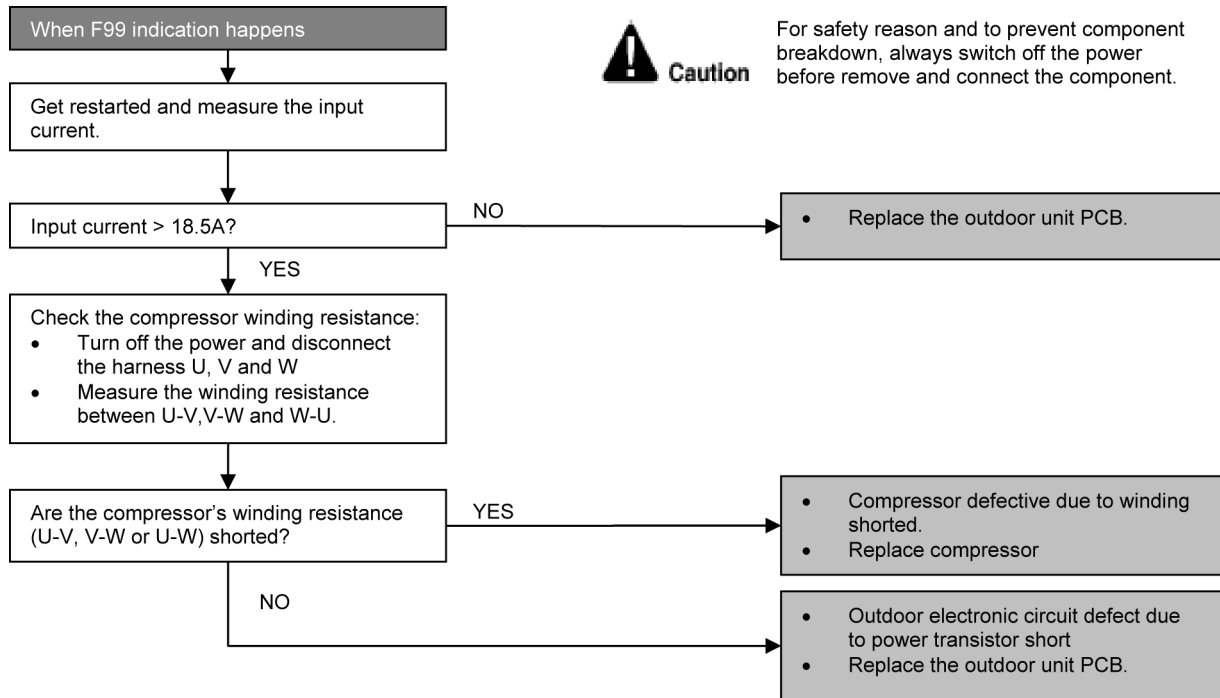

Caution

For safety reason and to prevent component breakdown, always switch off the power before remove and connect the component.

- Checking the power transistor.
- Never touch any live parts for at least 10 minutes after turning off the circuit breaker.
- If unavoidable necessary to touch a live part, make sure the power transistor's supply voltage is below 50V using the tester.
- For the UVW, make measurement at the Faston terminal on the board of the relay connector.

Tester's negative terminal	Power transistor (+)	UVW	Power transistor (-)	UVW
Tester's positive terminal	UVW	Power transistor (+)	UVW	Power transistor (-)
Normal resistance	Several kΩ to several MΩ			
Abnormal resistance	0 or ∞			

16 Disassembly and Assembly Instructions

WARNING

High Voltage are generated in the electrical parts area by the capacitor. Ensure that the capacitor has discharged sufficiently before proceeding with repair work. Failure to heed this caution may result in electric shocks.

16.1. Indoor Electronic Controllers, Cross Flow Fan and Indoor Fan Motor Removal Procedures

16.1.1. To remove front grille

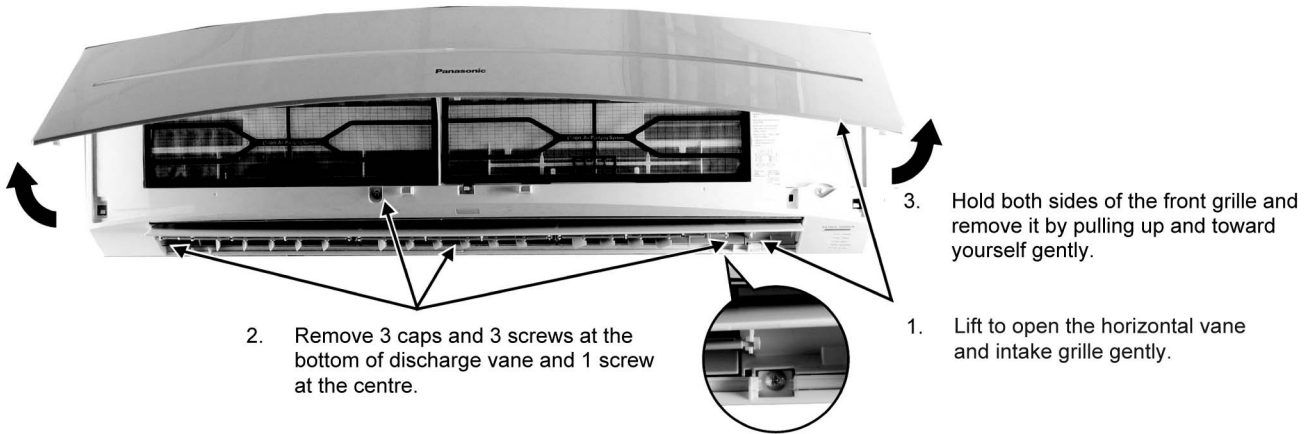

Figure 1

16.1.2. To remove horizontal vane

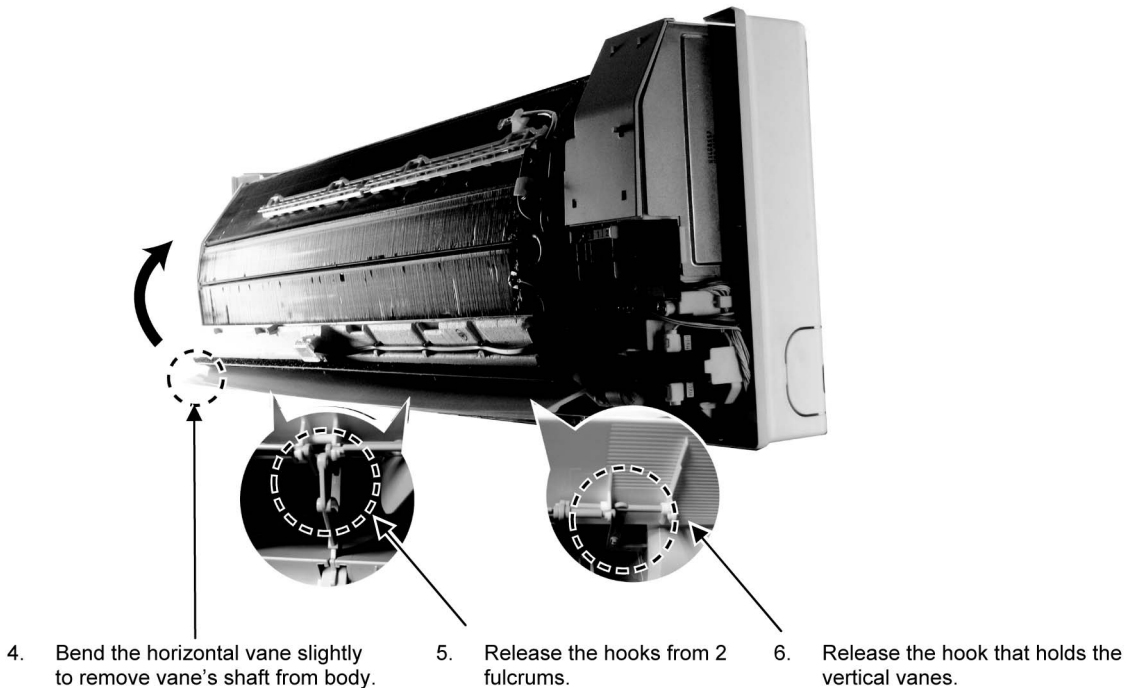

Figure 2

16.1.3. To remove power electronic controller

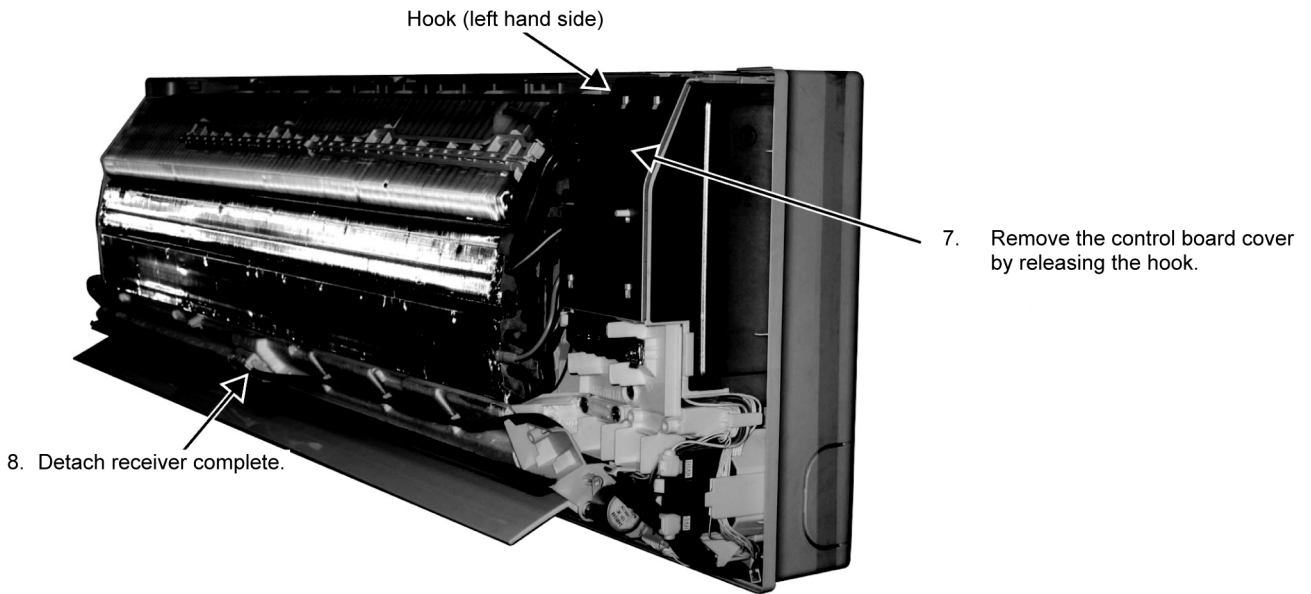

Figure 3

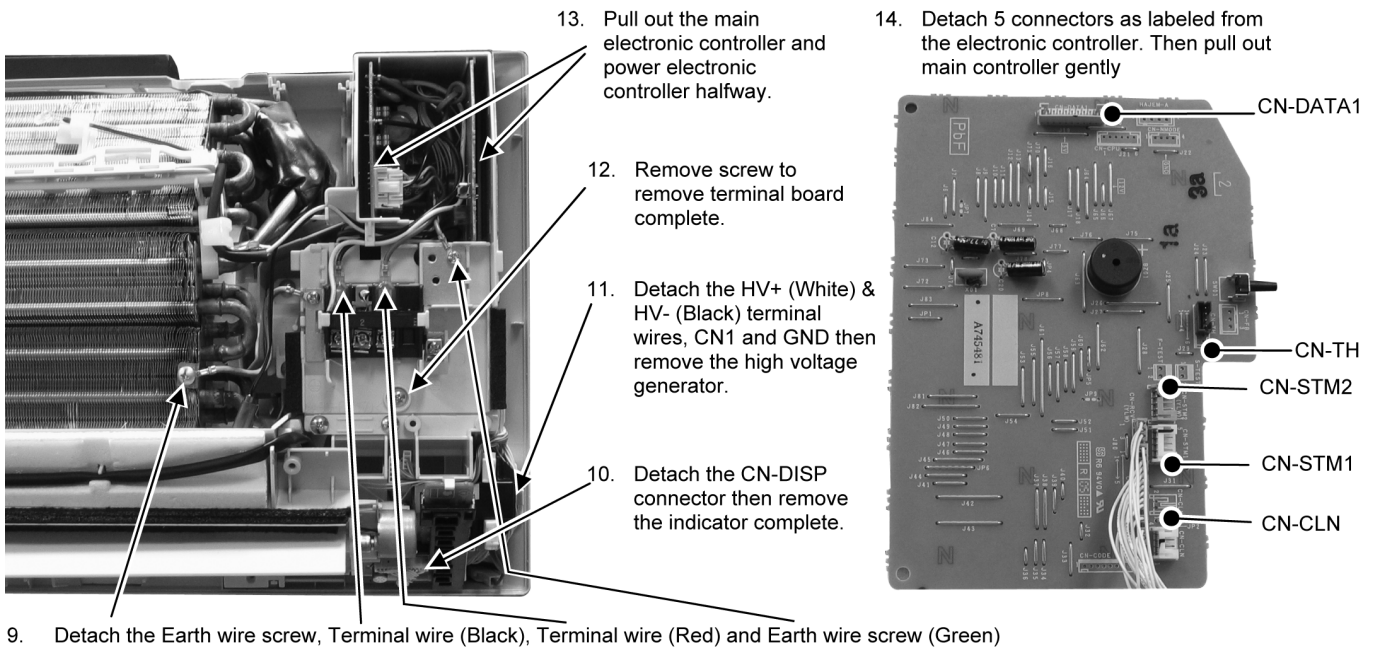

Figure 4

Figure 5

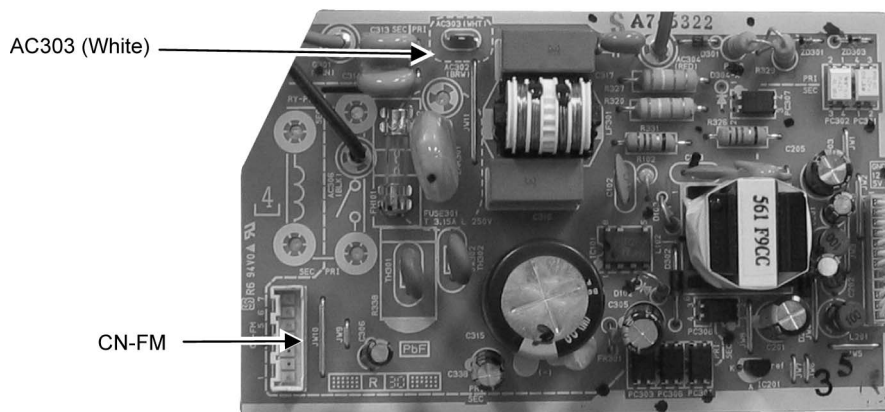

Figure 6

15. Detach the AC303 and CN-FM connectors from the electronic controller. Then pull out power electronic controller gently.

16.1.4. To remove discharge grille

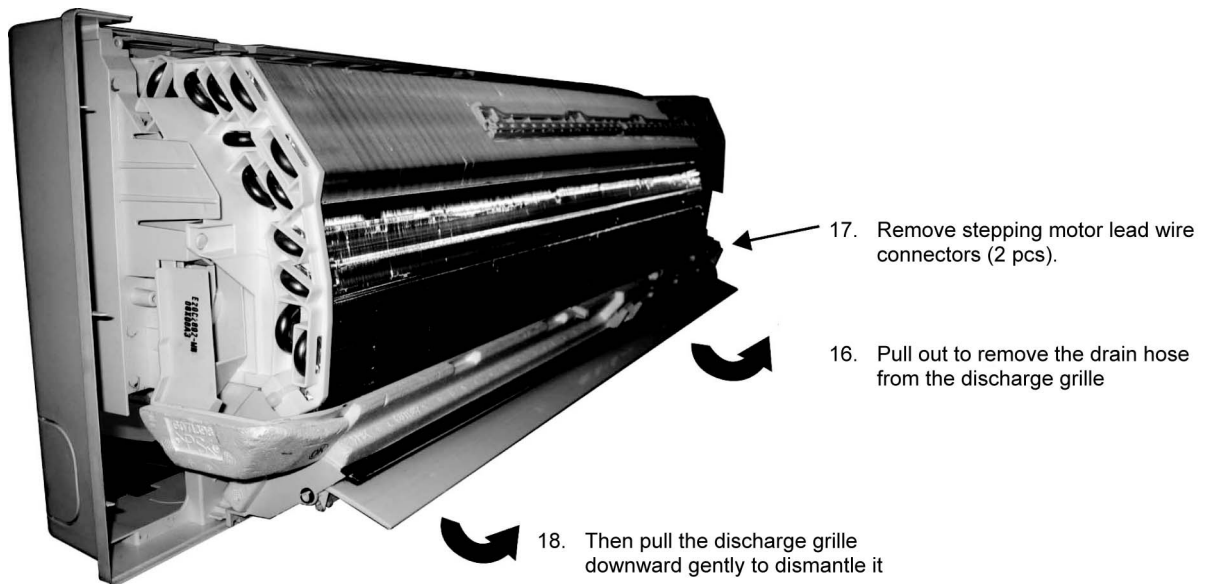

Figure 7

16.1.5. To remove control board

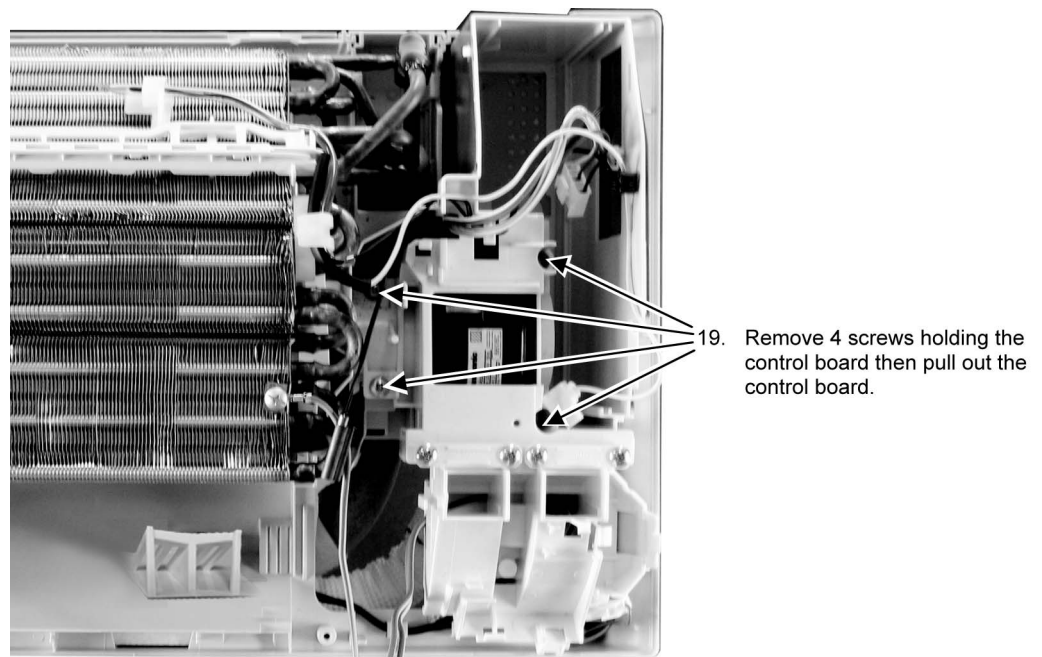
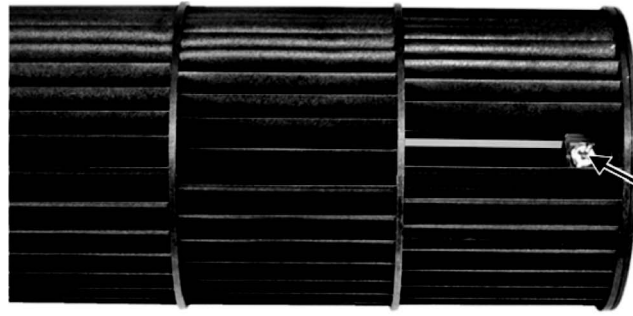

Figure 8

16.1.6. To remove cross flow fan and indoor fan motor



- 20. Remove the screw that holding the cross flow fan and fan motor axis.

Figure 9

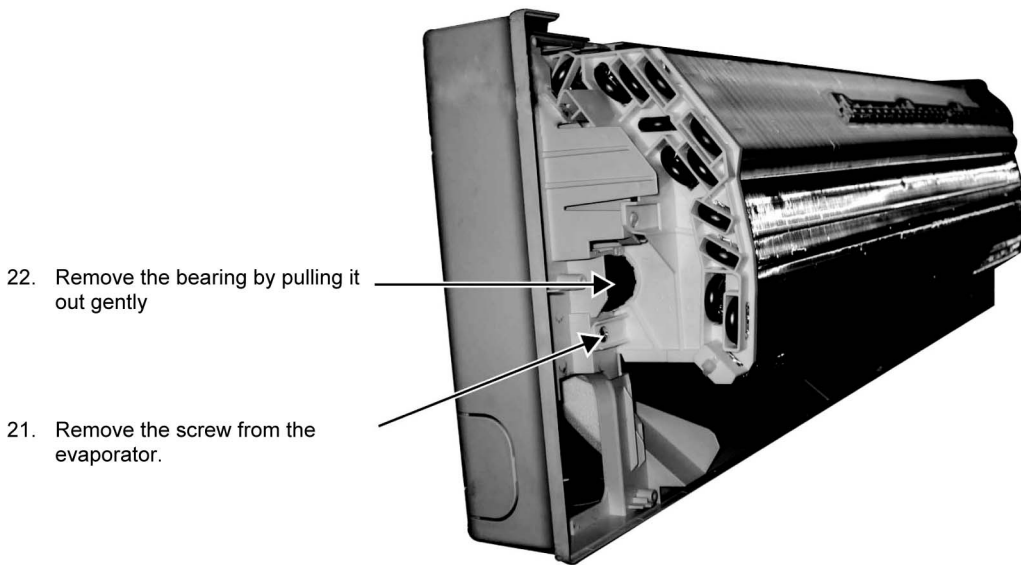

- 22. Remove the bearing by pulling it out gently
- 21. Remove the screw from the evaporator.

Figure 10

- 23. Push the holdfast to the left and lift up the evaporator.

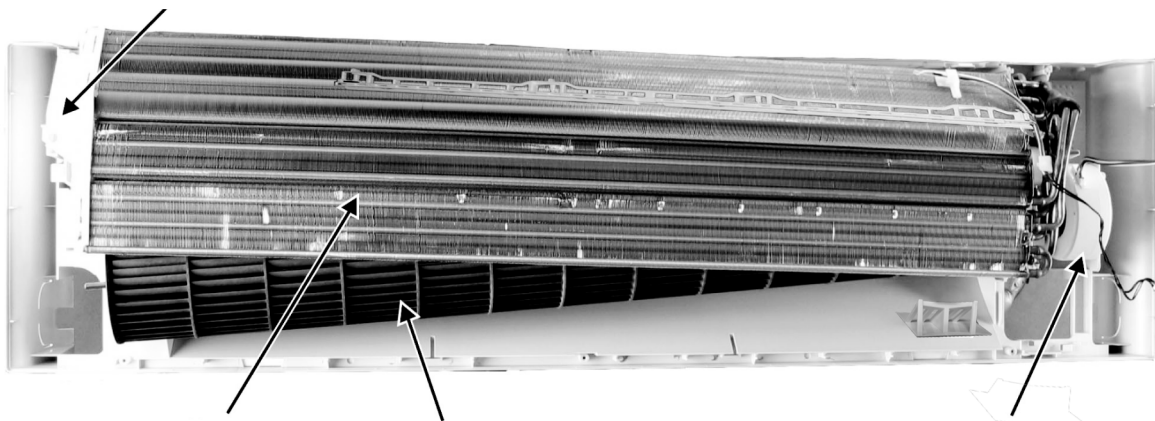

Evaporator

- 24. Remove the cross flow fan from the unit by pulling it to the left and downward.

- 25. Fan motor can be removed after the removal of cross flow fan.

Reminder: To reinstall the fan motor, adjust the fan motor connector to 45° towards you before fixing control board.

Figure 11

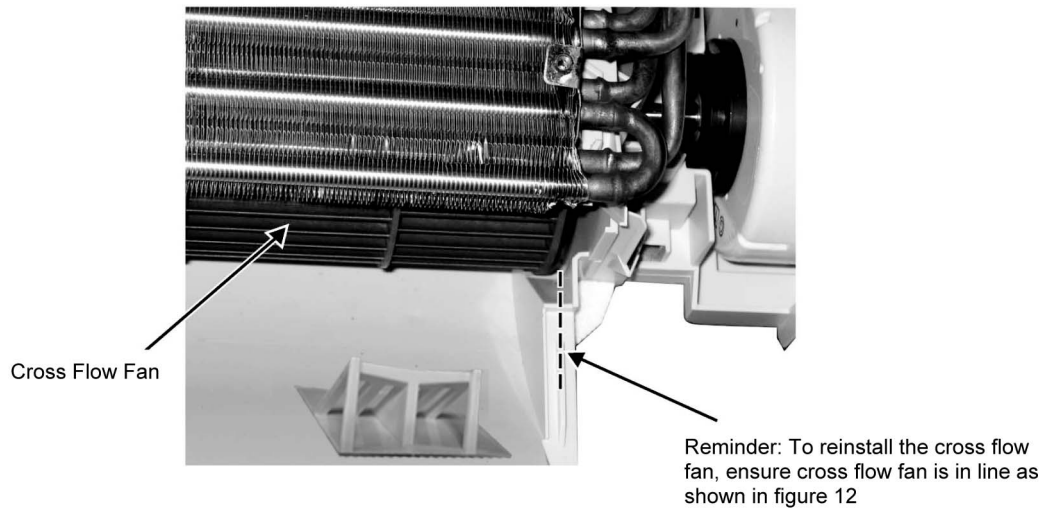

Figure 12

16.2. Outdoor Electronic Controller Removal Procedure (RE18JK)

1. Remove the 4 screws of the Top Panel.

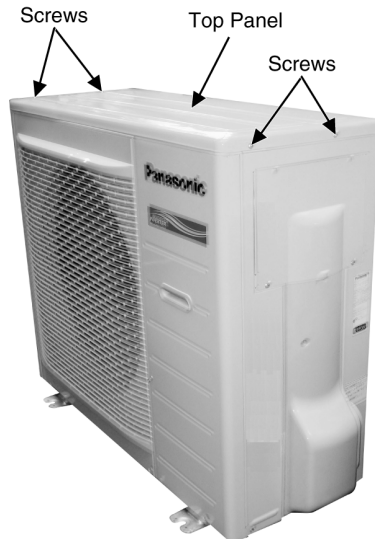

Fig. 1

2. Remove the 10 screws of the Front Panel.

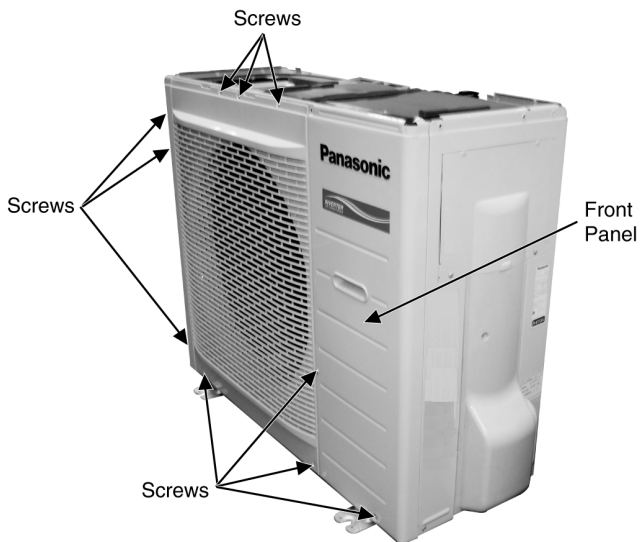

Fig. 2

3. Remove the Top Cover of the Electronic Controller.



Fig. 3

4. Remove the Control Board.

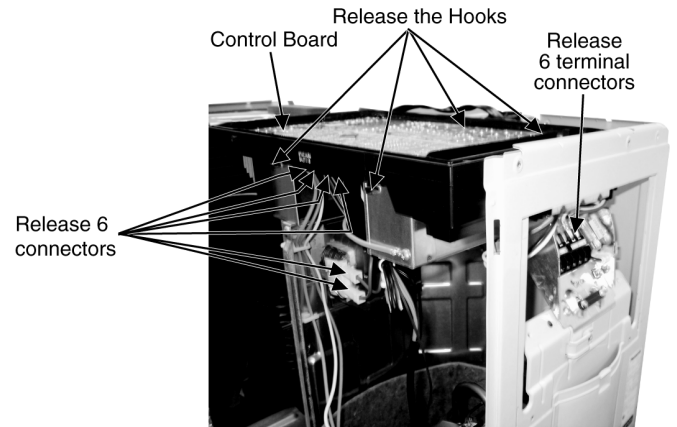

Fig. 4

5. Remove the 8 screws of the Electronic Controller.

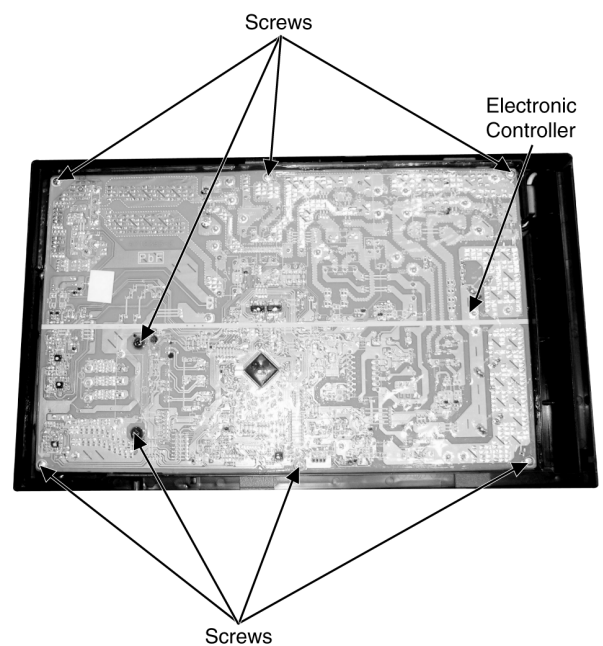

Fig. 5

⚠ Caution! When handling electronic controller, be careful of electrostatic discharge.

17 Technical Data

17.1. Operation Characteristics

17.1.1. CS-RE18JKE-1 CU-RE18JKE-1

Cooling Characteristic at Different Outdoor Air Temperature

Condition

Indoor room temperature: 27/19°C

Remote control setting: HI FAN, COOL 16°C

Compressor frequency: F_c

Voltage: 230 V

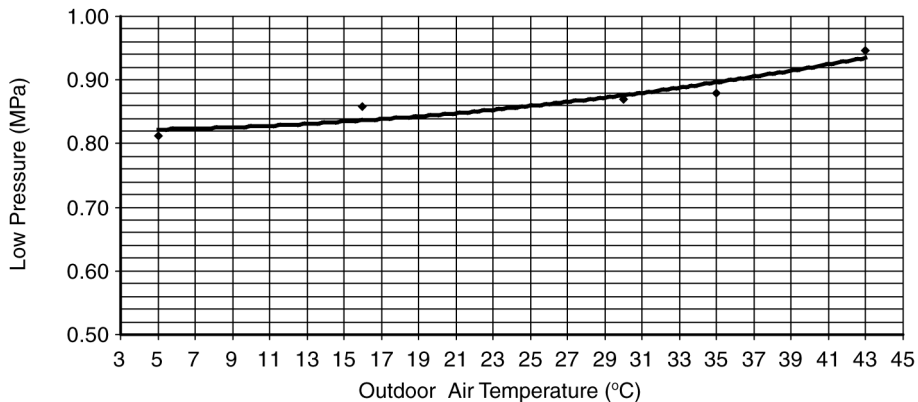
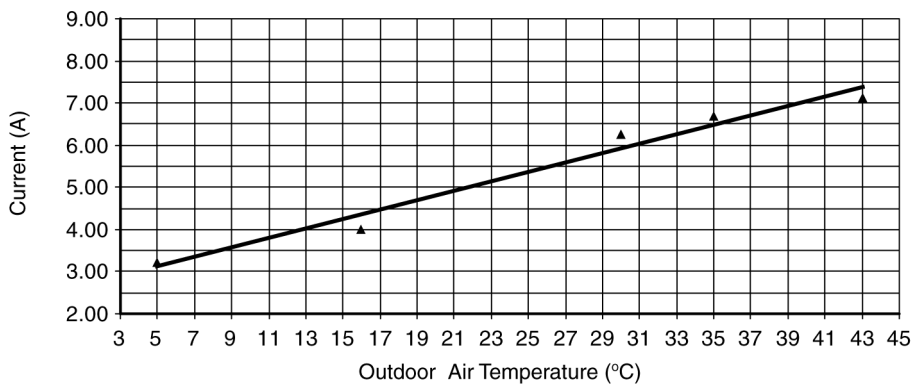
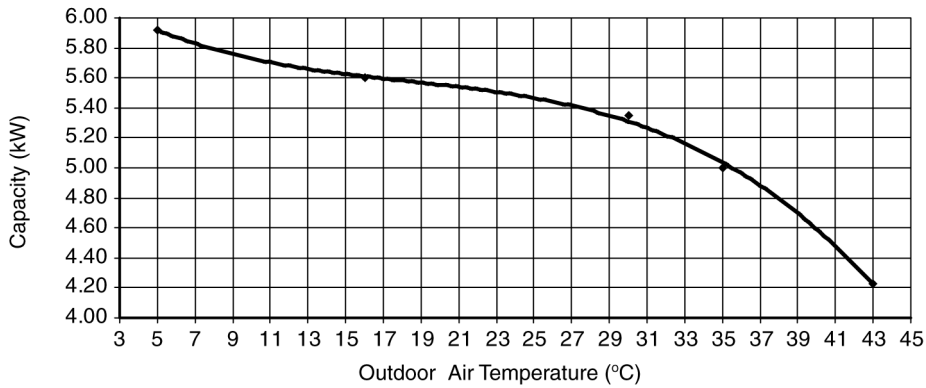
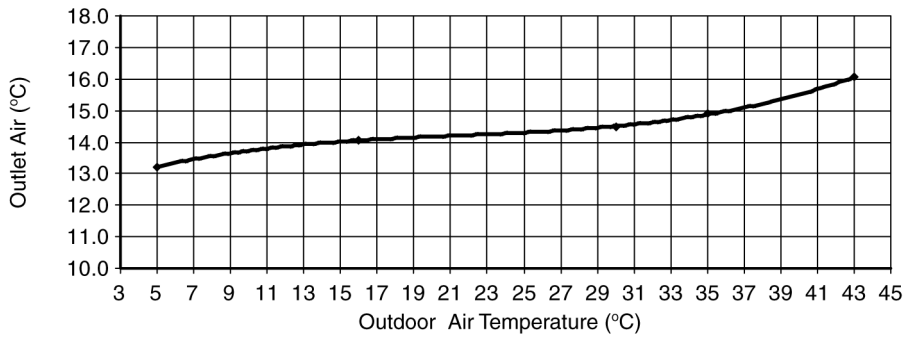

Cooling Characteristic at Different Piping Length

Condition

Indoor room temperature: 27/19°C, 35/-°C

Remote control setting: HI FAN, COOL 16°C

Compressor frequency: F_c

Voltage: 230 V

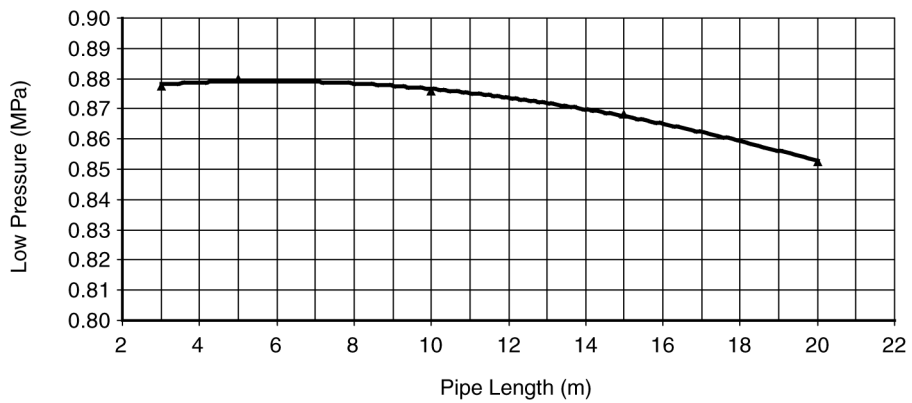
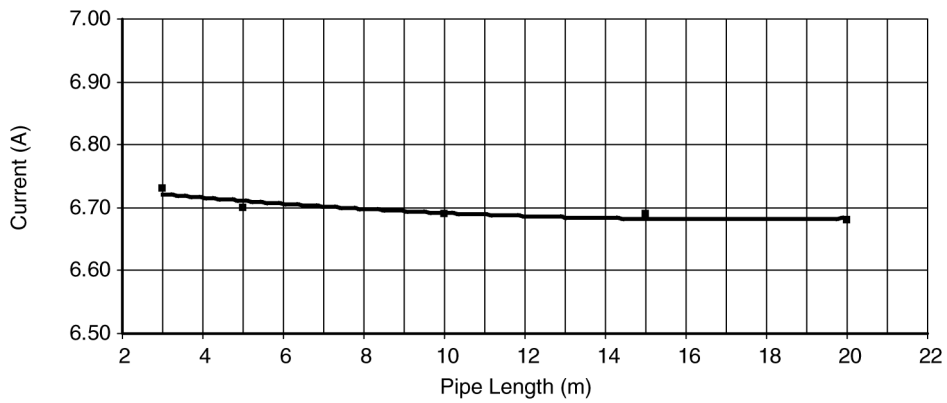
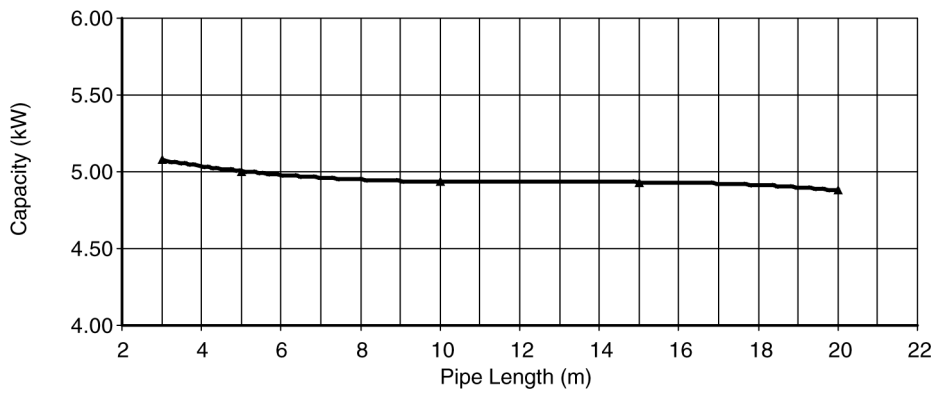
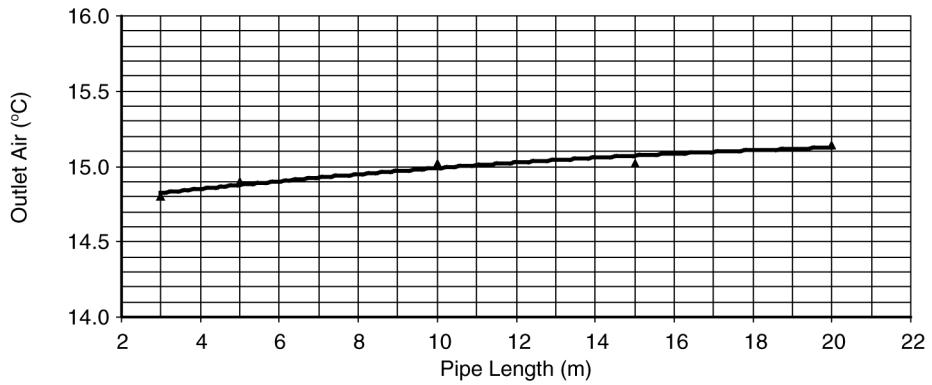

Heating Characteristic at Different Outdoor Air Temperature

Condition

Indoor room temperature: 20/-°C

Remote control setting: HI FAN, HEAT 30°C

Compressor frequency: F_h

Voltage: 230 V

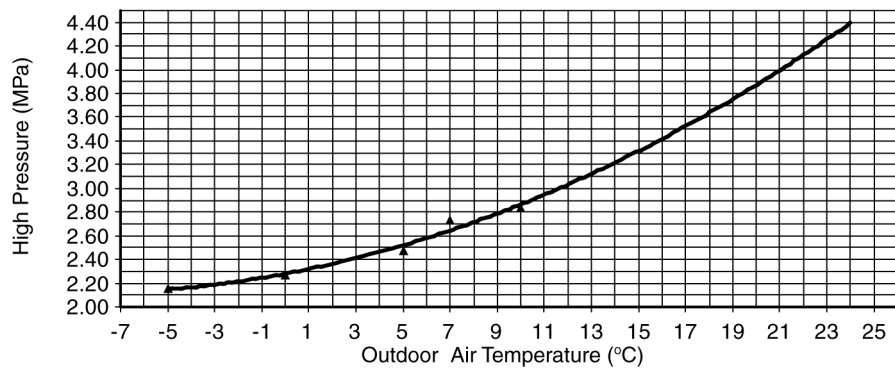
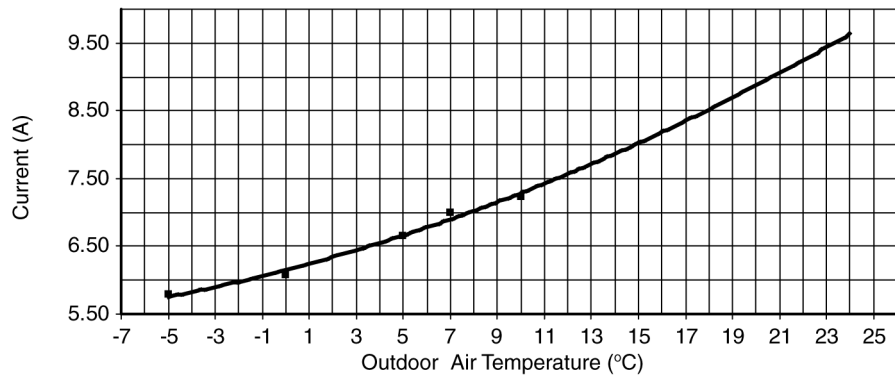
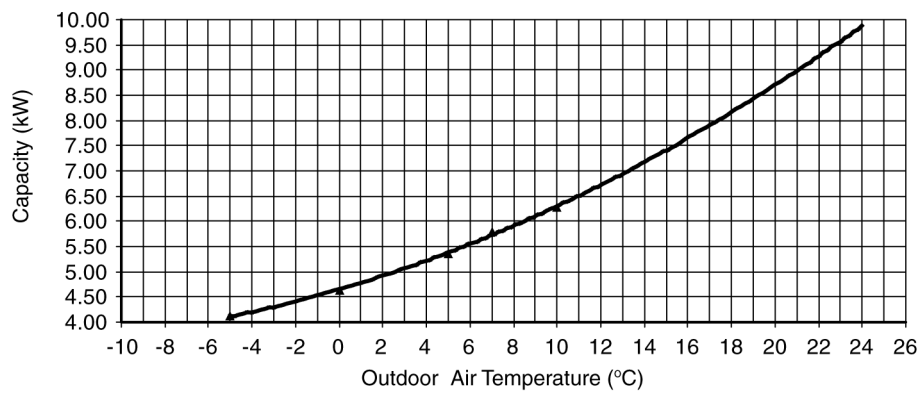
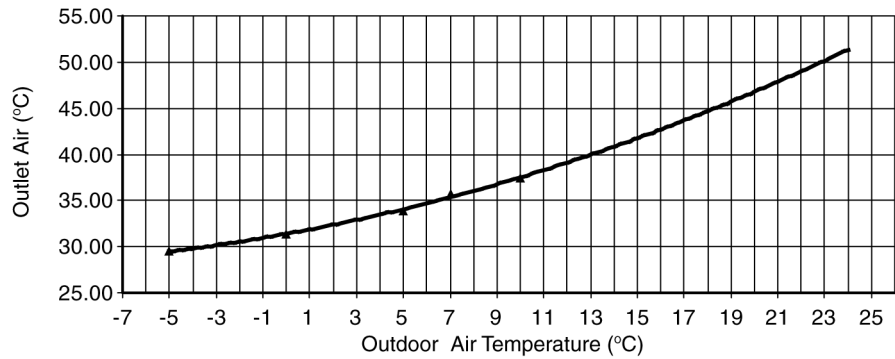

Heating Characteristic at Different Piping Length

Condition

Indoor room temperature: 20/-°C, 7/6°C

Remote control setting: HI FAN, HEAT 30°C

Compressor frequency: F_h

Voltage: 230 V

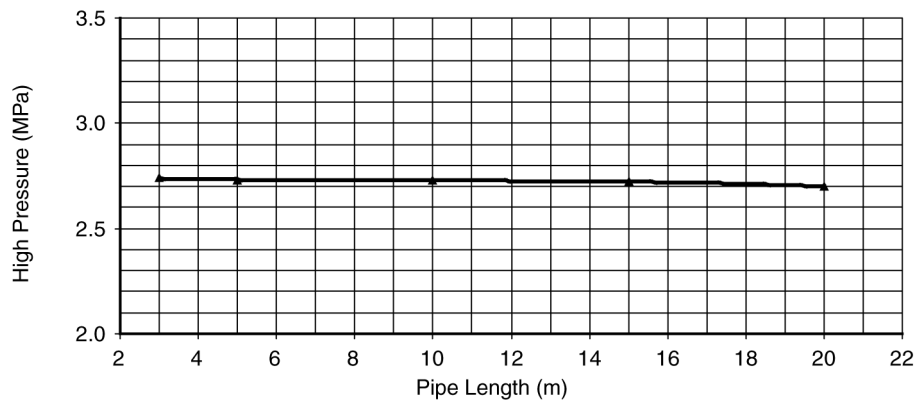
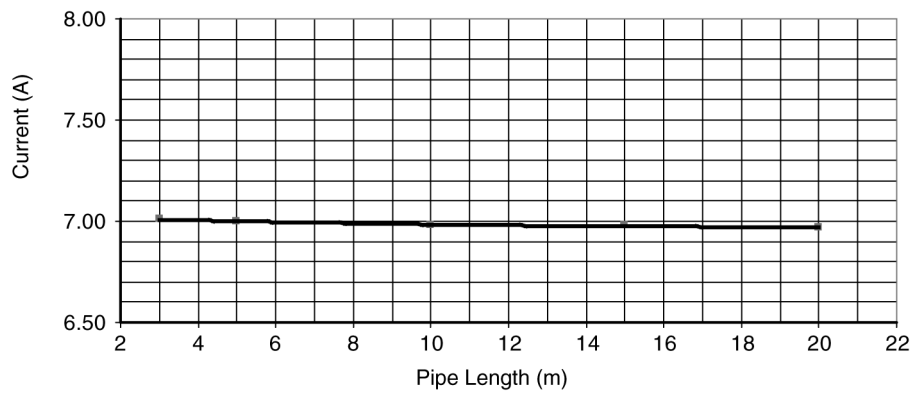
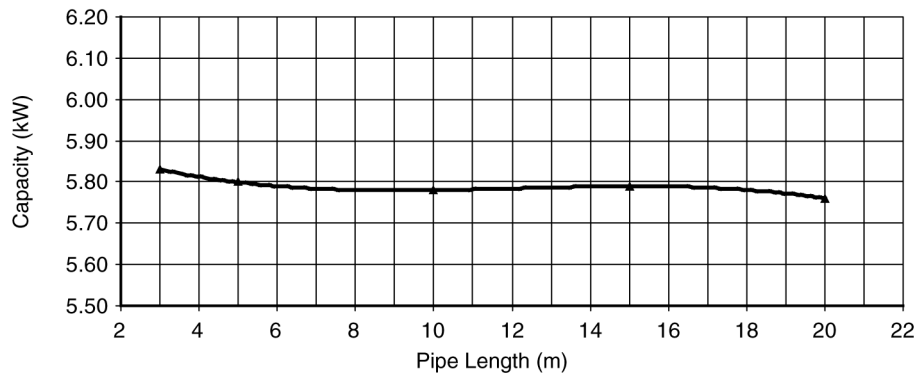
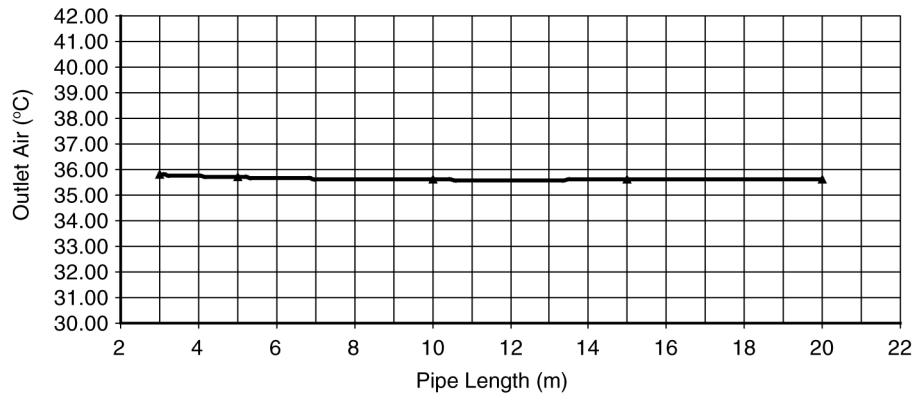

17.1.2. CS-RE24JKE-1 CU-RE24JKE-1

Cooling Characteristic at Different Outdoor Air Temperature

Condition

Indoor room temperature: 27/19°C

Remote control setting: HI FAN, COOL 16°C

Compressor frequency: F_c

Voltage: 230 V

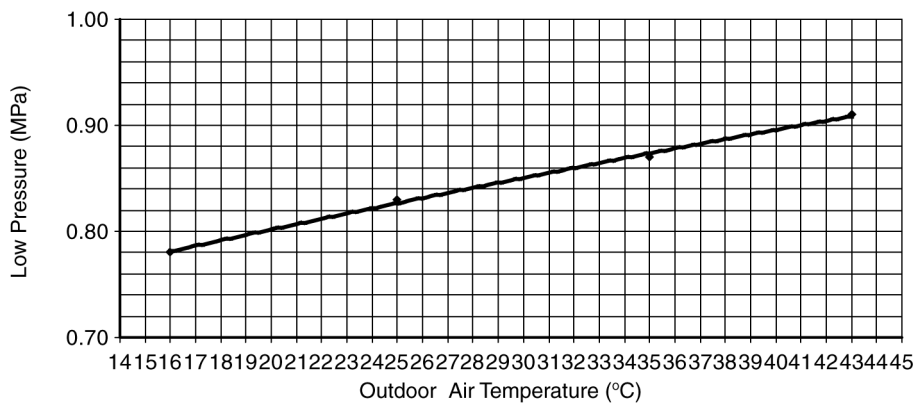
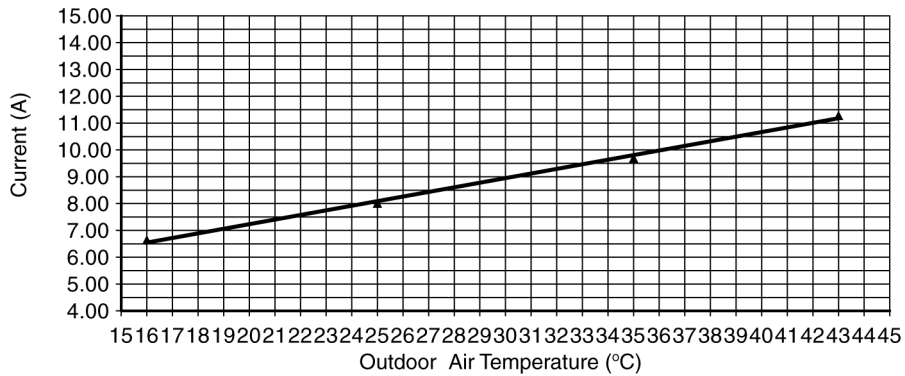
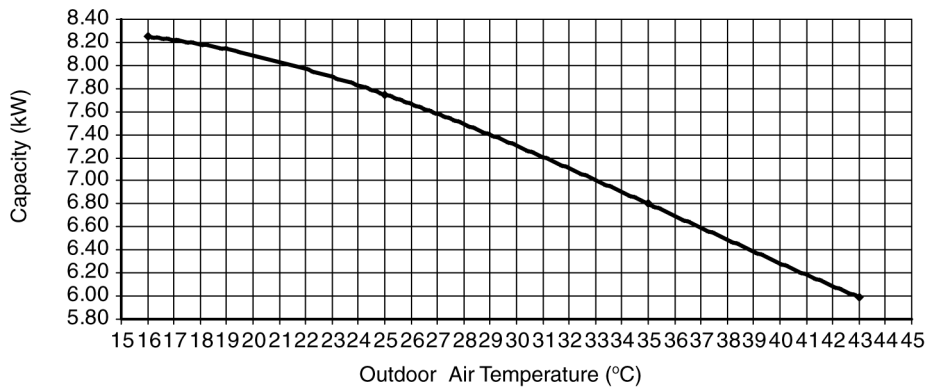
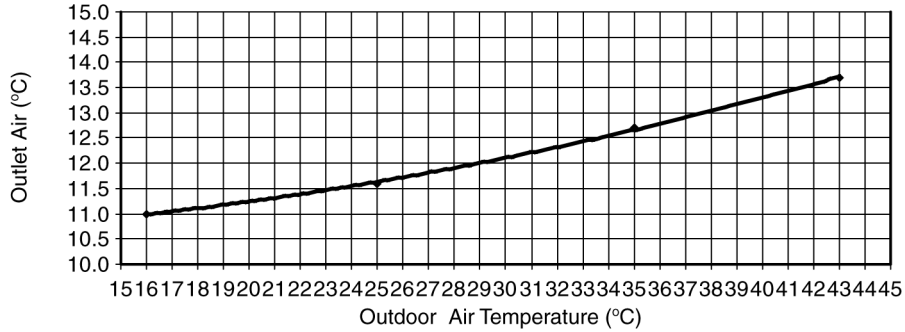

Cooling Characteristic at Different Piping Length

Condition

Indoor room temperature: 27/19°C, 35/-°C

Remote control setting: HI FAN, COOL 16°C

Compressor frequency: F_c

Voltage: 230 V

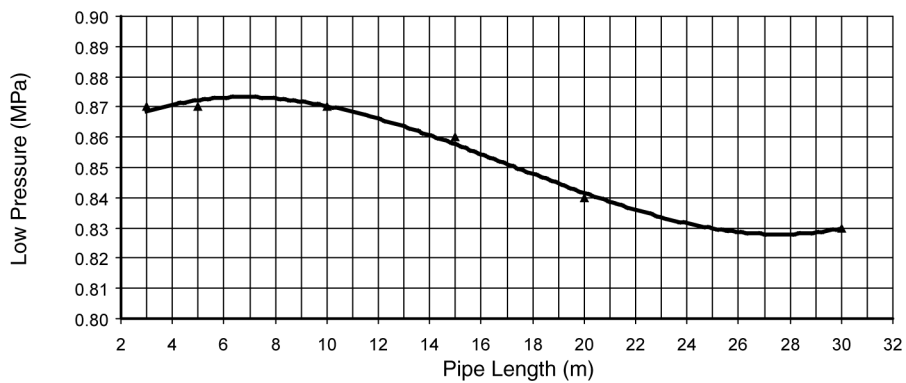
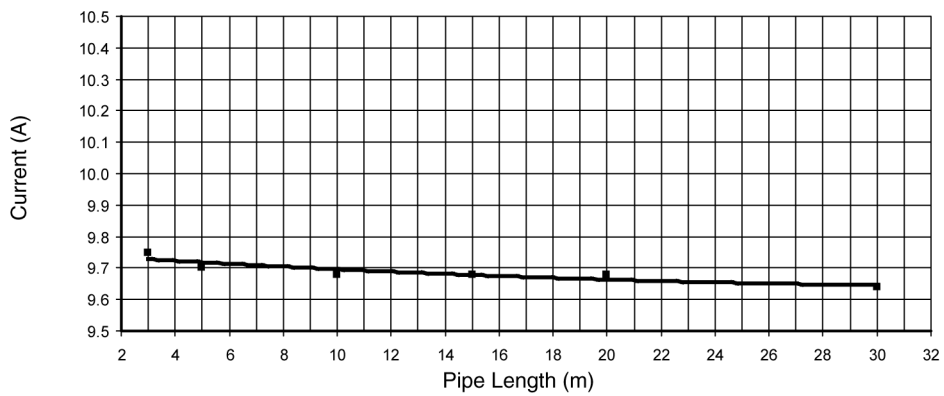
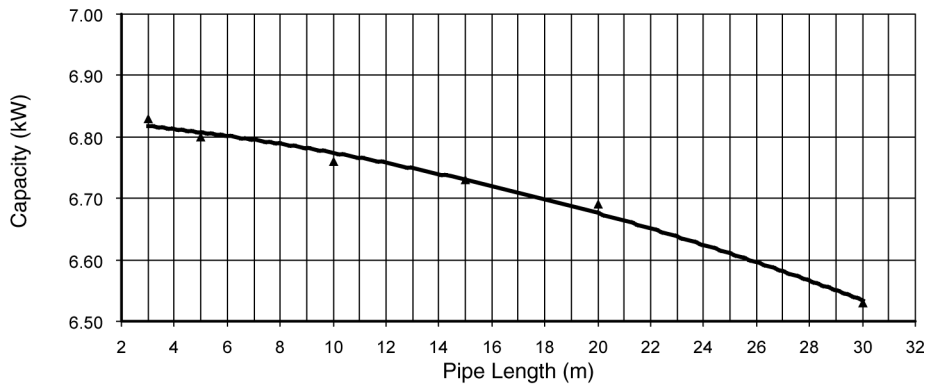
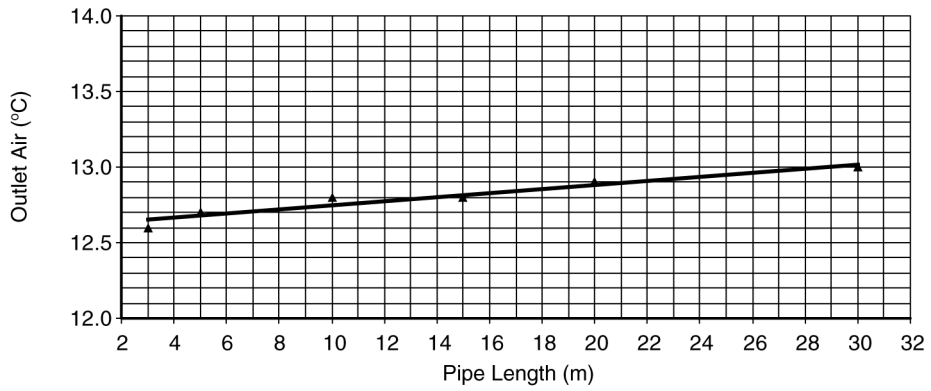

Heating Characteristic at Different Outdoor Air Temperature

Condition

Indoor room temperature: 20/-°C

Remote control setting: HI FAN, HEAT 30°C

Compressor frequency: F_h

Voltage: 230 V

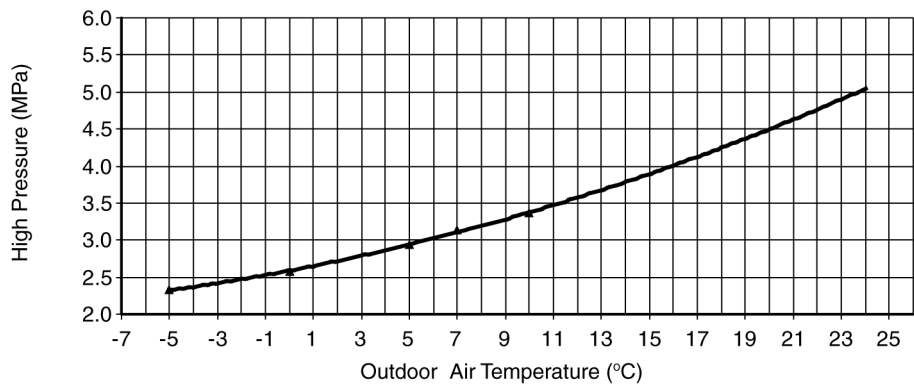
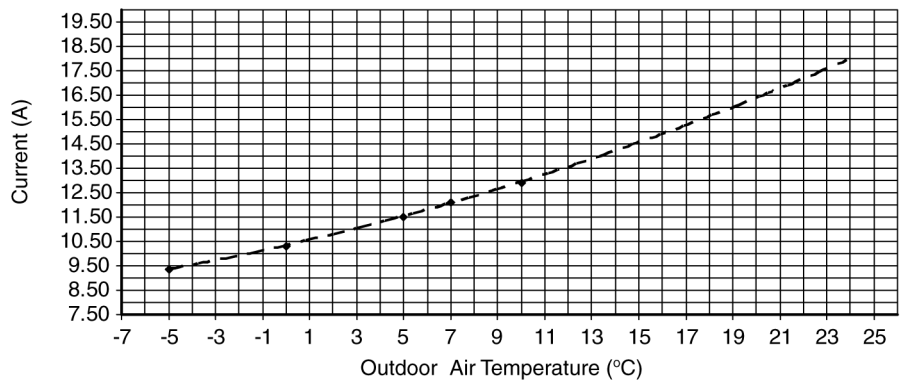
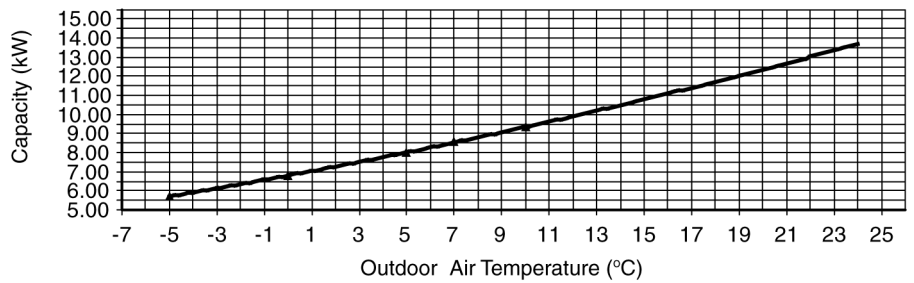
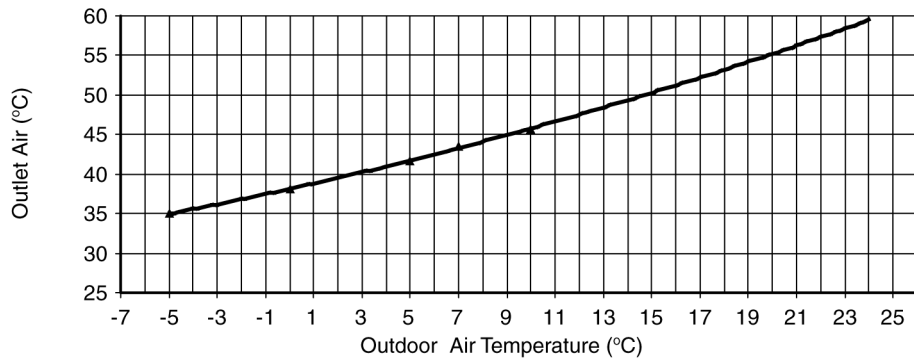

Heating Characteristic at Different Piping Length

Condition

Indoor room temperature: 20/-°C, 7/6°C

Remote control setting: HI FAN, HEAT 30°C

Compressor frequency: F_h

Voltage: 230 V

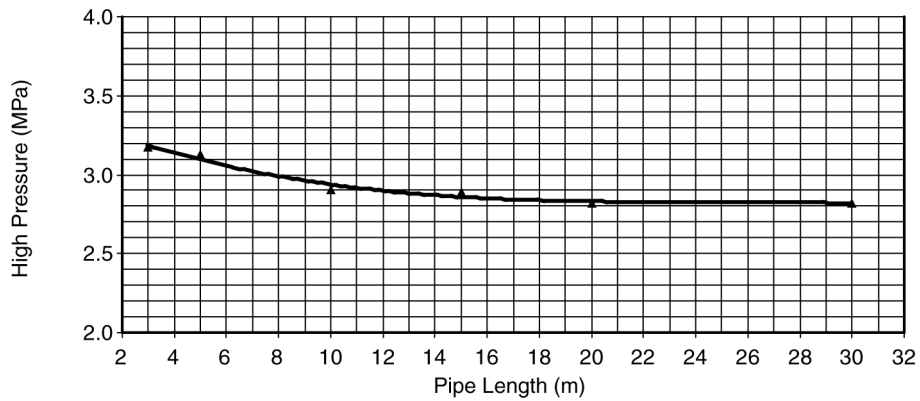
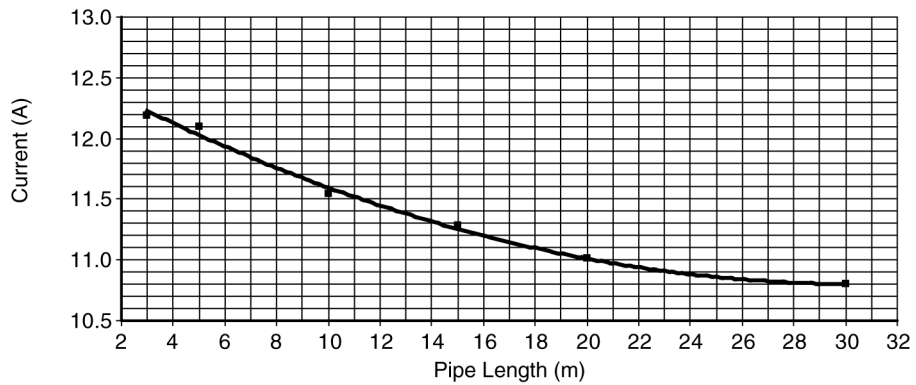
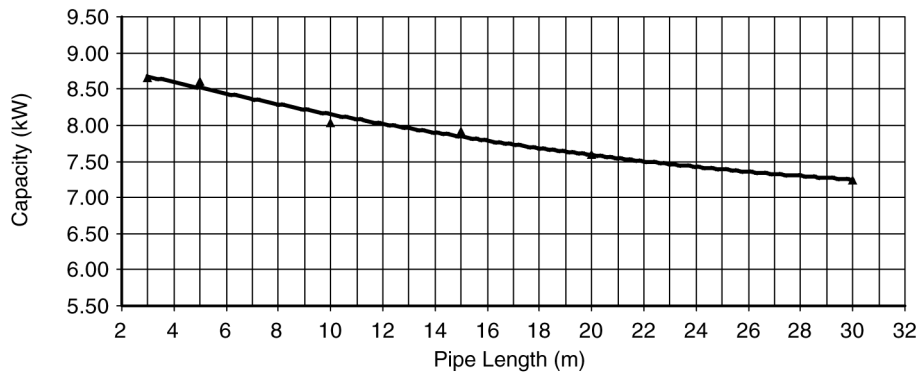
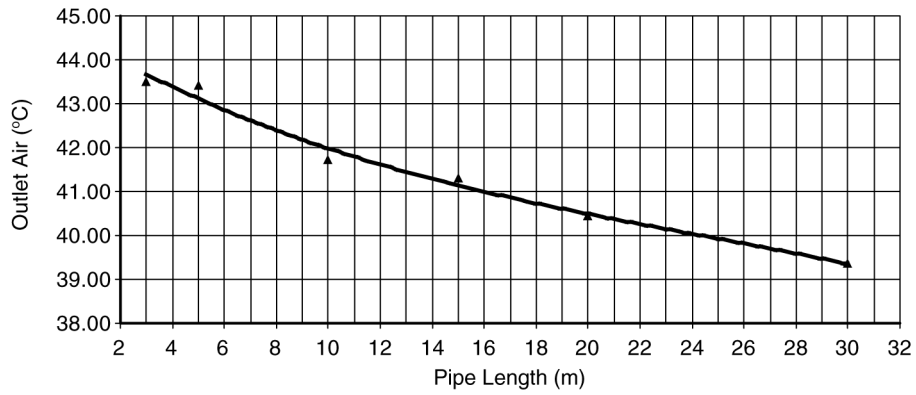

17.2. Sensible Capacity Chart

● CS-RE18JKE-1 CU-RE18JKE-1

Indoor wet bulb temp.	Outdoor Temp. (°C)											
	30			35			40			46		
	TC	SHC	IP	TC	SHC	IP	TC	SHC	IP	TC	SHC	IP
17.0°C	4.96	3.76	1.35	4.64	3.61	1.45	4.31	3.47	1.55	3.92	3.29	1.67
19.0°C				5.00		1.47						
19.5°C	5.45	3.94	1.37	5.09	3.78	1.48	4.74	3.64	1.58	4.31	3.47	1.70
22.0°C	5.94	4.08	1.40	5.55	3.93	1.50	5.16	3.79	1.61	4.69	3.61	1.73

● CS-RE24JKE-1 CU-RE24JKE-1

Indoor wet bulb temp.	Outdoor Temp. (°C)											
	30			35			40			46		
	TC	SHC	IP	TC	SHC	IP	TC	SHC	IP	TC	SHC	IP
17.0°C	6.75	5.11	1.94	6.30	4.90	2.09	5.86	4.71	2.23	5.33	4.48	2.41
19.0°C				6.80		2.12						
19.5°C	7.41	5.35	1.98	6.92	5.14	2.13	6.44	4.95	2.28	5.85	4.71	2.45
22.0°C	8.07	5.55	2.01	7.54	5.34	2.17	7.02	5.15	2.32	6.38	4.91	2.50

TC - Total Cooling Capacity (kW)
 SHC - Sensible Heat Capacity (kW)
 IP - Input Power (kW)

Indoor 27°C/19°C
 Outdoor 35°C/24°C

18 Exploded View and Replacement Parts List

18.1. Indoor Unit

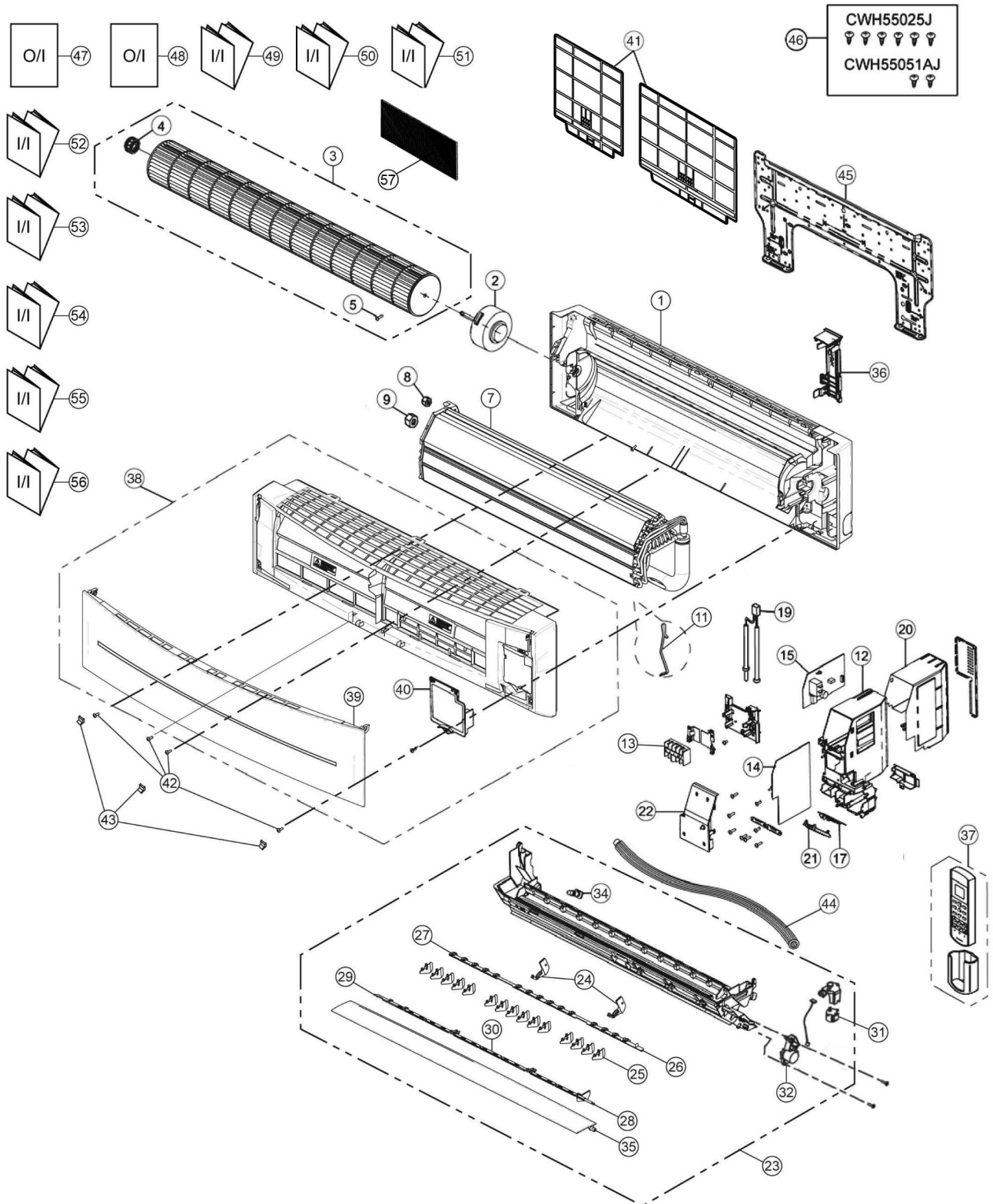

<Model: CS-RE18JKE-1 CS-RE24JKE-1>

REF NO.	PART NAME & DESCRIPTION	QTY.	CS-RE18JKE-1	CS-RE24JKE-1	REMARKS
1	CHASSY COMPLETE	1	CWD50C1654	←	
2	FAN MOTOR	1	L6CBYYYYL0039	←	O
3	CROSS FLOW FAN COMPLETE	1	CWH02C1077	←	
4	BEARING ASS'Y	1	CWH64K007	←	
5	SCREW - CROSS FLOW FAN	1	CWH551146	←	
7	EVAPORATOR	1	CWB30C2900	CWB30C2777	
8	FLARE NUT (LIQUID)	1	CWT251030	←	
9	FLARE NUT (GAS)	1	CWT251032	CWT251033	
11	HOLDER SENSOR	1	CWH32143	←	
12	CONTROL BOARD CASING	1	CWH102370	←	
13	TERMINAL BOARD COMPLETE	1	CWA28C2357	←	O
14	ELECTRONIC CONTROLLER - MAIN	1	CWA73C4488	CWA73C4490	O
15	ELECTRONIC CONTROLLER - POWER	1	CWA745322	←	O
17	ELECTRONIC CONTROLLER-INDICATOR & RECEIVER	1	CWA745300	←	O
19	SENSOR COMPLETE	1	CWA50C2401	←	O
20	CONTROL BOARD TOP COVER	1	CWH131350	←	
21	INDICATOR HOLDER	1	CWD933021	←	
22	CONTROL BOARD FRONT COVER	1	CWH13C1183	←	
23	DISCHARGE GRILLE COMPLETE	1	CWE20C3007	←	
24	FULCRUM	2	CWH621103	←	
25	VERTICAL VANE	15	CWE241289	←	
26	CONNECTING BAR	1	CWE261156	←	
27	CONNECTING BAR	1	CWE261158	←	
28	CONNECTING BAR	1	CWE261157	←	
29	CONNECTING BAR	1	CWE261159	←	
30	CONNECTING BAR	1	CWE261160	←	
31	AIR SWING MOTOR	1	CWA981241	←	O
32	AIR SWING MOTOR	1	CWA98K1014	←	O
33	LEAD WIRE - AIR SWING MOTOR	1	-	-	
34	CAP - DRAIN TRAY	1	CWH521096	←	
35	HORIZONTAL VANE	1	CWE24C1295	←	
36	BACK COVER CHASSIS	1	CWD933031	←	
37	REMOTE CONTROL COMPLETE	1	CWA75C3293	←	O
38	FRONT GRILLE COMPLETE	1	CWE11C4163	CWE11C4162	O
39	INTAKE GRILLE COMPLETE	1	CWE22C1512	←	O
40	GRILLE DOOR	1	CWE14C1029	←	
41	AIR FILTER	2	CWD001283	←	
42	SCREW - FRONT GRILLE	3	XTT4+16CFJ	←	
43	CAP - FRONT GRILLE	3	CWH521194	←	
44	DRAIN HOSE	1	CWH851173	←	
45	INSTALLATION PLATE	1	CWH361098	←	
46	BAG COMPLETE - INSTALLATION SCREW	1	CWH82C1705	←	
47	OPERATING INSTRUCTION	1	CWF567353	←	
48	OPERATING INSTRUCTION	1	CWF567354	←	
49	INSTALLATION INSTRUCTION	1	CWF613909	←	
50	INSTALLATION INSTRUCTION	1	CWF613910	←	
51	INSTALLATION INSTRUCTION	1	CWF613911	←	
52	INSTALLATION INSTRUCTION	1	CWF613912	←	
53	INSTALLATION INSTRUCTION	1	CWF613913	←	
54	INSTALLATION INSTRUCTION	1	CWF613914	←	
55	INSTALLATION INSTRUCTION	1	CWF613915	←	
56	INSTALLATION INSTRUCTION	1	CWF613916	←	

REF NO.	PART NAME & DESCRIPTION	QTY.	CS-RE18JKE-1	CS-RE24JKE-1	REMARKS
57	SUPER ALLERU BUSTER FILTER	1	CWD00C1263	←	

(Note)

- All parts are supplied from PHAAM, Malaysia (Vendor Code: 00029488).
- "O" marked parts are recommended to be kept in stock.

18.2. CU-RE18JKE-1

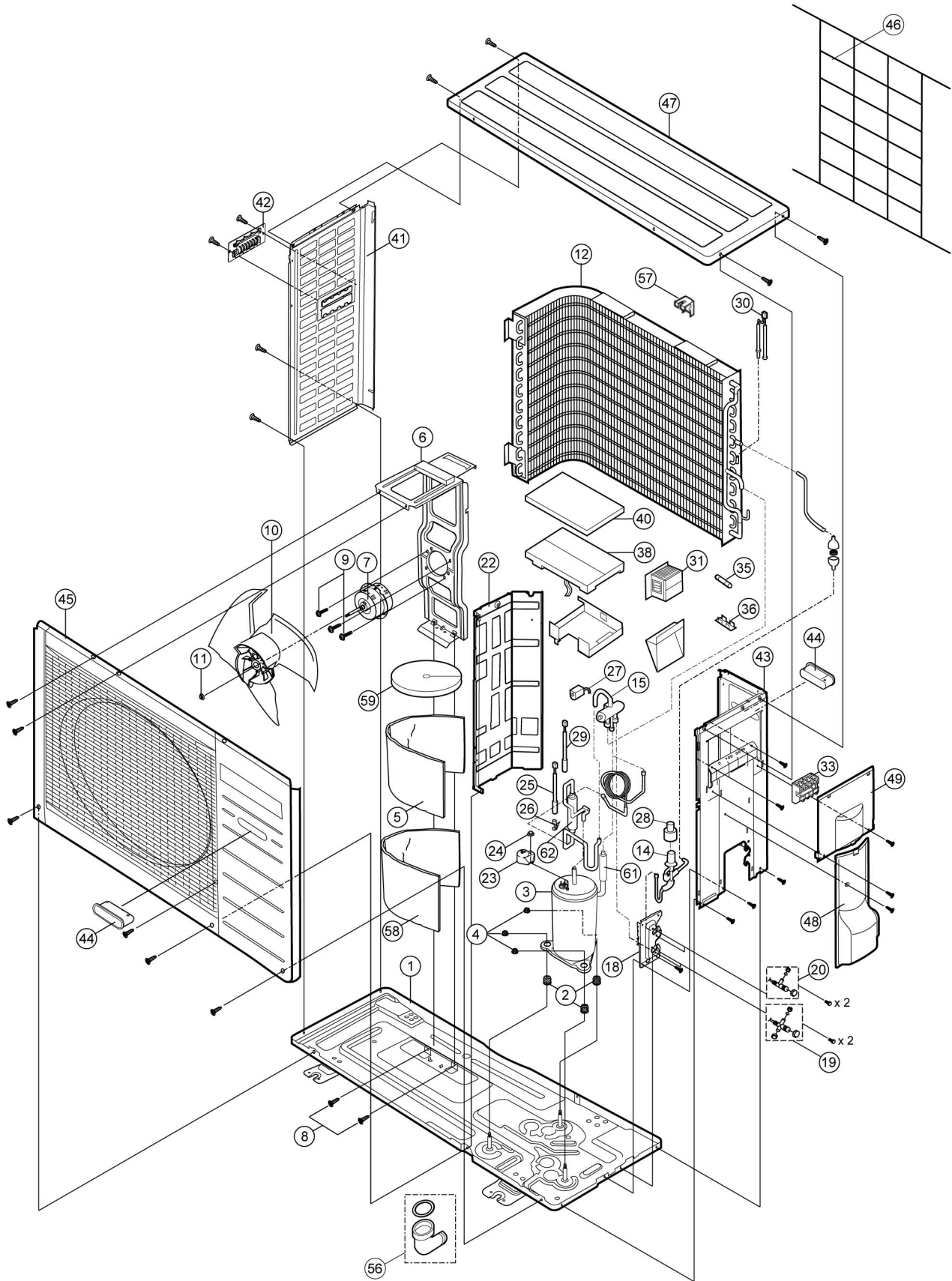

Note:
The above exploded view is for the purpose of parts disassembly and replacement.
The non-numbered parts are not kept as standard service parts.

REF NO.	PART NAME & DESCRIPTION	QTY.	CU-RE18JKE-1	REMARKS
1	CHASSY ASS'Y	1	CWD50K2085	
2	ANTI-VIBRATION BUSHING	3	CWH50077	
3	COMPRESSOR	1	5CS130XAD04	O
4	NUT-COMPRESSOR MOUNT	3	CWH56000J	
5	SOUND PROOF MATERIAL	1	CWG302302	
6	FAN MOTOR BRACKET	1	CWD541054	
7	FAN MOTOR	1	CWA981166J	O
8	SCREW - FAN MOTOR BRACKET	3	CWH551217	
9	SCREW - FAN MOTOR MOUNT	3	CWH551106J	
10	PROPELLER FAN ASSY	1	CWH03K1016	
11	NUT - PROPELLER FAN	1	CWH56053J	
12	CONDENSER	1	CWB32C2816	
14	TUBE ASSY (EXP.VALVE)	1	CWT023679	O
15	4-WAYS VALVE	1	CWB001026J	
16	STRAINER	1	CWB11094	
18	HOLDER - COUPLING	1	CWH351056	
19	3 WAYS VALVE (GAS)	1	CWB011361	O
20	2 WAYS VALVE (LIQUID)	1	CWB021292	O
22	SOUND PROOF BOARD	1	CWH151050	
23	TERMINAL COVER	1	CWH171039A	
24	NUT-TERMINAL COVER	1	CWH7080300J	
25	SENSOR CO-OUTDOOR COMPRESSOR TEMP	1	CWA50C2185	
26	HOLDER SENSOR	1	CWH32074	
27	V-COIL COMPLETE FOR 4 WAY VALVE	1	CWA43C2168J	
28	V-COIL COMPLETE FOR EXP.VALVE	1	CWA43C2058J	
29	SENSOR CO-OUTDOOR DISCHARGE TEMP.	1	CWA50C2180	
30	SENSOR CO-OUTDOOR AIR TEMP AND HEAT EXCHANGE TEMP.	1	CWA50C2181	
31	REACTOR	1	G0C203J00003	
33	TERMINAL BOARD ASSY	1	CWA28K1110J	
35	FUSE CAP TERMINAL	1	K5D303BBA002	
36	FUSE HOLDER	1	K3GB1PH00016	
37	EXPANSION VALVE	1	CWB051016J	
38	ELECTRONIC CONTROLLER - MAIN	1	CWA73C4476R	O
40	CONTROL BOARD COVER (TOP PCB)	1	CWH131167	
41	CABINET SIDE PLATE (L)	1	CWE041255A	
42	HANDLE	1	CWE161010	
43	CABINET SIDE PLATE (R)	1	CWE041158A	
44	HANDLE	2	CWE16000E	
45	CABINET FRONT PLATE CO.	1	CWE06K1043	
46	WIRE NET	1	CWD041041A	
47	CABINET TOP PLATE	1	CWE031031A	
48	CONTROL BOARD COVER (BOTTOM)	1	CWH131168	
49	CONTROL BOARD COVER (RIGHT-TOP)	1	CWH131169A	
56	ACCESSORY CO.(DRAIN ELBOW)	1	CWG87C900	
57	HOLDER SENSOR	1	CWMH320001	
58	SOUND PROOF MATERIAL	1	CWG302270	
59	SOUND PROOF MATERIAL	1	CWG302300	
61	ACCUMULATOR	1	CWB131024	

REF NO.	PART NAME & DESCRIPTION	QTY.	CU-RE18JKE-1	REMARKS
62	RECEIVER	1	CWB14011	

(Note)

- All parts are supplied from PHAAM, Malaysia (Vendor Code: 00029488).
- "O" marked parts are recommended to be kept in stock.

18.3. CU-RE24JKE-1

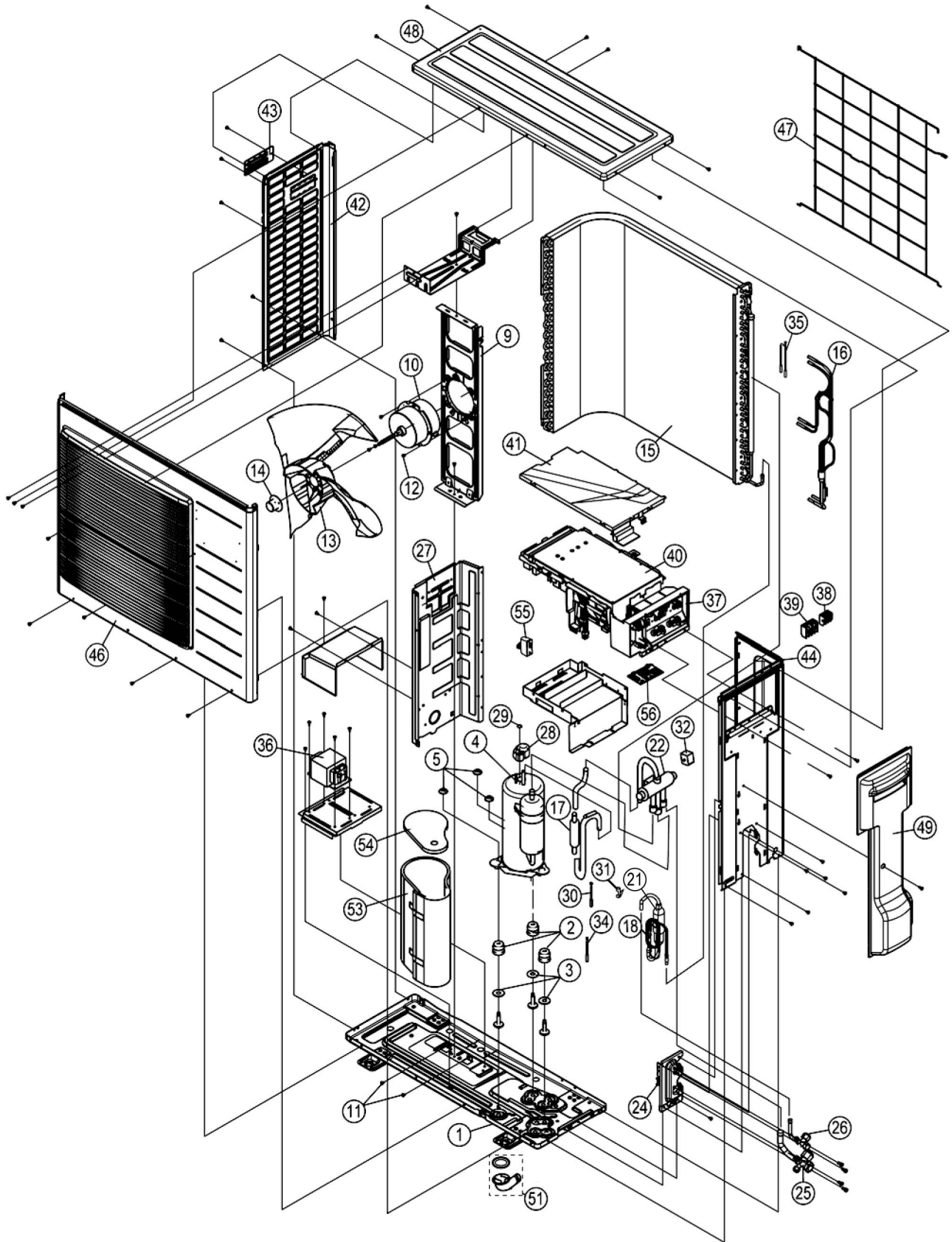

Note:

The above exploded view is for the purpose of parts disassembly and replacement.
The non-numbered parts are not kept as standard service parts.

REF NO.	PART NAME & DESCRIPTION	QTY.	CU-RE24JKE-1	REMARKS
1	CHASSY ASS'Y	1	CWD52K1190	
2	ANTI - VIBRATION BUSHING	3	CWH50055	
3	PACKING	3	CWB81043	
4	COMPRESSOR	1	5KD240XAF21	O
5	NUT - COMPRESSOR MOUNT	3	CWH561049	
9	FAN MOTOR BRACKET	1	CWD541126	
10	FAN MOTOR	1	CWA951636	O
11	SCREW - FAN MOTOR BRACKET	3	CWH551217	
12	SCREW - FAN MOTOR MOUNT	3	CWH551040J	
13	PROPELLER FAN ASS'Y	1	CWH001019	
14	NUT - PROPELLER FAN	1	CWH561038J	
15	CONDENSER COMPLETE	1	CWB32C2715	
16	TUBE ASSY (CAP.TUBE)	1	CWT01C4686	
17	DISCHARGE MUFFLER	1	CWB121013	
18	TUBE ASSY (CAP.TUBE & RECEIVER)	1	CWT01C4733	
21	RECEIVER	1	CWB14030	
22	4 WAYS VALVE	1	CWB001026J	O
24	HOLDER - COUPLING	1	CWH351057	
25	3 WAYS VALVE (GAS)	1	CWB011363	O
26	2 WAYS VALVE (LIQUID)	1	CWB021434	O
27	SOUND PROOF BOARD	1	CWH151197	
28	CONTROL BOARD CASING (SIDE)	1	CWH102361	
29	TERMINAL COVER	1	CWH171039A	
30	TERMINAL BOARD ASSY	1	CWA28K1076J	
31	NUT - TERMINAL COVER	1	CWH7080300J	
32	TERMINAL BOARD ASSY	1	CWA28K1162	
34	SENSOR COMPLETE (COMP. TOP)	1	CWA50C2185	
35	HOLDER SENSOR	1	CWH711010	
36	V-COIL COMPLETE	1	CWA43C2169J	
37	SENSOR CO (COMP.DISCHARGE)	1	CWA50C2515	
38	SENSOR COMPLETE	1	CWA50C2517	O
39	REACTOR	2	G0C403J00001	O
40	ELECTRONIC CONTROLLER - MAIN	1	CWA73C4478R	O
41	CONTROL BOARD COVER (TOP)	1	CWH131333	
42	CABINET SIDE PLATE (L)	1	CWE041317A	
43	HANDLE	1	CWE161010	
44	CABINET SIDE PLATE (R)	1	CWE041319A	
46	CABINET FRONT PLATE ASSY	1	CWE06K1063	
47	WIRE NET	1	CWD041128A	
48	CABINET TOP PLATE	1	CWE031083A	
49	CONTROL BOARD COVER (R)	1	CWH13C1185	
51	ACCESSORY CO. (DRAIN ELBOW)	1	CWG87C900	
53	SOUND PROOF MATERIAL	1	CWG302245	
54	SOUND PROOF MATERIAL	1	CWG302246	
55	CAPACITOR-FM (3.5MF/460V)	1	DS461305QP-A	
56	ELECTRONIC CONTROLLER	1	CWA745133	

(Note)

- All parts are supplied from PHAAM, Malaysia (Vendor Code: 00029488).
- "O" marked parts are recommended to be kept in stock.