

Service Manual

Room Air Conditioner

CS-V28BKP5/CU-V28BKP5
(Refrigerant:R407C)



⚠ WARNING

This service information is designed for experienced repair technicians only and is not designed for use by the general public. It does not contain warnings or cautions to advise non-technical individuals of potential dangers in attempting to service a product. Products powered by electricity should be serviced or repaired only by experienced professional technicians. Any attempt to service or repair the product or products dealt with in this service information by anyone else could result in serious injury or death.

CONTENTS

	Page		Page
1 Features	2	11 3-way Valve	50
2 Functions	3	12 Servicing Information	57
3 Product Specifications	6	13 Troubleshooting Guide	61
4 Dimensions	8	14 Technical Data	63
5 Refrigeration Cycle Diagram	9	15 Exploded View	65
6 Block Diagram	10	16 Replacement Parts List	66
7 Wiring Diagram	11	17 Exploded View	67
8 Operation Details	12	18 Replacement Parts List	68
9 Operating Instructions	19	19 Electronic Parts List	69
10 Installation Instructions	39	20 Electronic Circuit Diagram	70

Panasonic

© 2001 Matsushita Air-Conditioning Corp. Sdn. Bhd. (183914D) All rights reserved. Unauthorized copying and distribution is a violation of law.

1 Features

- High Efficiency
- High Efficiency Airflow Circuit
- Compact Design
- Auto Restart after Power Failure
- Long Piping up to 30m
- Catechin Deodorizing Air Filter
- Deodorizing Control during operation

2 Functions

Remote Control

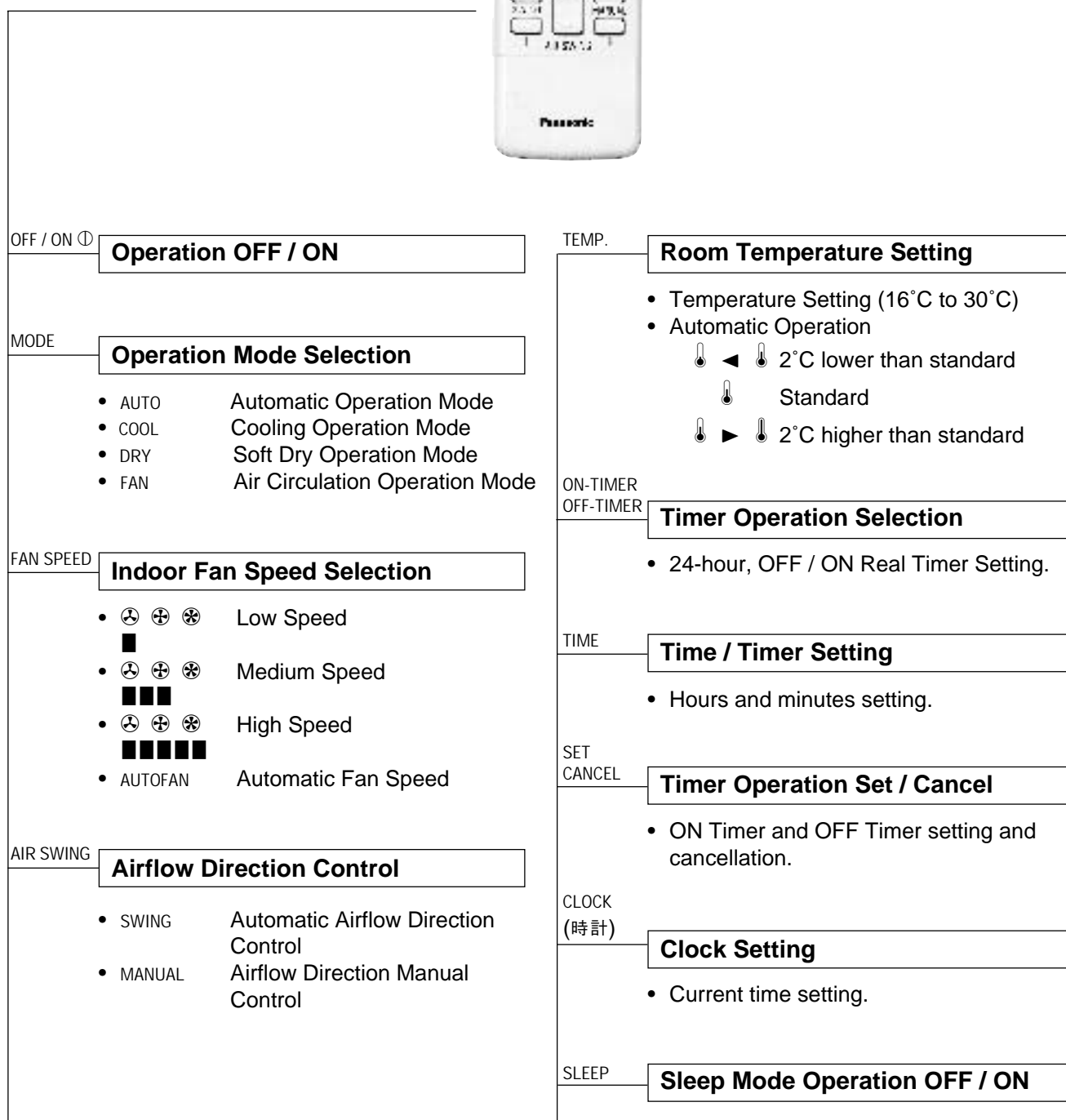

Indoor Unit

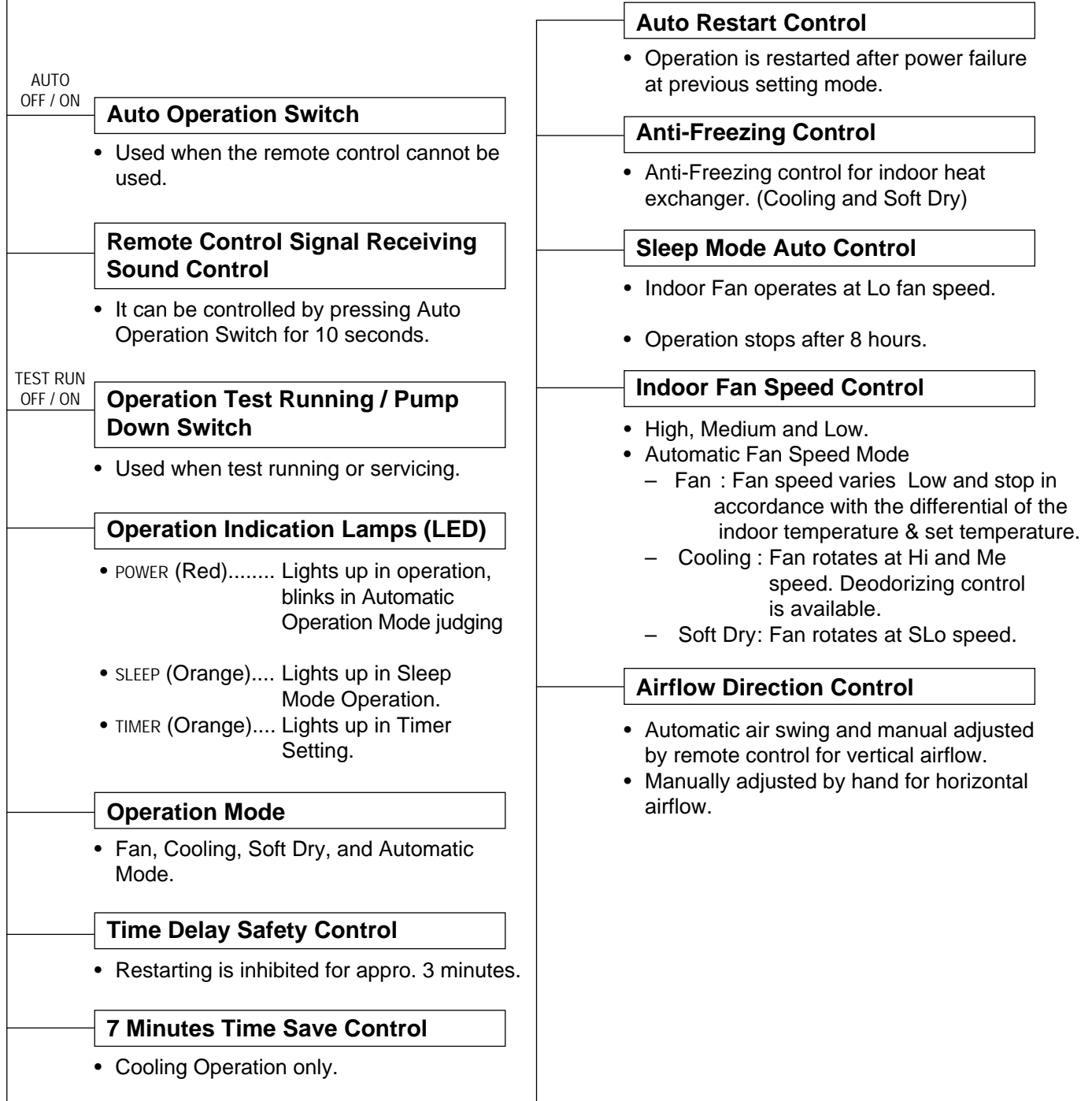

Outdoor Unit



Overload Protector

- Inner protector (Compressor, Fan Motor).

60 Secs. Forced Operation Control

- Once the compressor is activated, it does not stop for 60 secs. (Stops immediately with remote control stop signal.)

Outdoor Fan Operation Control

- 4-pole induction motor (2-speed)
- For Cooling or Soft Dry Operation
 - Hi-speed ... when outdoor temperature reaches to 31°C
 - Lo-speed ... when outdoor temperature reaches to 29°C

3 Product Specifications

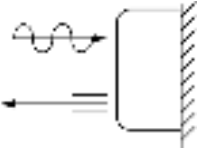
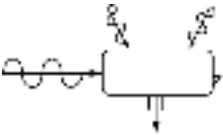
		Unit	CS-V28BKP5	CU-V28BKP5
Cooling Capacity		kW Btu/h	7.90 - 7.80 27,000 - 26,600	
_____		kW Btu/h	_____	
Moisture Removal		l/h Pint/h	4.6 9.7	
Power Source		Phase V Cycle	Single 230 - 220 50	
Airflow Method		OUTLET = ' . INTAKE = . . .	SIDE VIEW 	TOP VIEW 
Air Volume	Indoor Air (Lo)	m ³ /min (cfm)	Cooling; 14.2 (501)	—
	Indoor Air (Me)	m ³ /min (cfm)	Cooling; 15.0 (530)	—
	Indoor Air (Hi)	m ³ /min (cfm)	Cooling; 16.3 (575)	—
	Outdoor Air	m ³ /min (cfm)	—	Cooling; 59.0 (2,083)
Noise Level		dB (A)	Cooling; 48/46/44	Cooling; 63/55
Electrical Data	Input	kW	Cooling; 2.98 -2.95	
	Running Current	A	Cooling; 14.0 - 14.5	
	COP	W/W	Cooling; 2.7 - 2.6	
	Starting Current	A	82	
Piping Connection Port (Flare piping)		inch inch	G ; Half Union 5/8" L ; Half Union 1/4"	G ; 3-way valve 5/8" L ; 3-way valve 1/4"
Pipe Size (Flare piping)		inch inch	G (gas side); 5/8" L (liquid side); 1/4"	G (gas side); 5/8" L (liquid side); 1/4"
Drain Hose	Inner diameter	mm	14	
	Length	m	0.73	
				—

Power Cord Length		m	2.1	—	
Number of core-wire			3 (2.5 mm ²)	—	
Dimensions	Height	inch (mm)	14 - 9/16 (370)	26 - 31/32 (685)	
	Width	inch (mm)	48 - 1/32 (1,220)	34 - 21/32 (880)	
	Depth	inch (mm)	8 - 21/32 (220)	13 - 19/32 (345)	
Net Weight		lb (kg)	40 (18)	146 (66)	
Compressor	Type		—	Scroll type	
	Motor Type		—	Induction (2-poles)	
	Rated Output	kW	—	2.88	
Air Circulation	Type		Cross-flow Fan	Propeller Fan	
	Material		AS + Glass Fiber 30%	AS + Glass Fiber 20%	
	Motor Type		Induction (4-poles)	Induction (4-poles)	
	Input	W	—	—	
	Rated Output	W	40	100	
	Fan Speed	Low	rpm	Cooling; 1,262 Heating; 1,250	920 - 880
		Medium	rpm	Cooling; 1,322 Heating; 1,328	—
High		rpm	Cooling; 1,418 Heating; 1,420	1,200 - 1,170	
Heat Exchanger	Description		Evaporator	Condenser	
	Tube material		Copper	Copper	
	Fin material		Aluminium	Aluminium	
	Fin Type		Louver	Louver	
	Row / Stage		(Plate fin configuration, forced draft)		
			2 x 10	2 x 26	
	FPI		18	18	
Size (W x H x L)	mm	966.5 x 254 x 44	826 x 663.9 x 44		
Refrigerant Control Device			—	Capillary Tube	
Refrigeration Oil		(cm ³)	—	SONTEX 200 LT (1,242)	
Refrigerant (R-407C)		g (oz)	—	1,760 (62.1)	
Thermostat			Electronic Control	Electronic Control	
Protection Device			Inner Protector	Inner Protector	
Capillary Tube	Length	mm	—	Cooling; 300	
	Flow Rate	l/min	—	Cooling; 29.2 (0.03MPa)	
	Inner Diameter	mm	—	Cooling; 2.3	
Air Filter	Material		A.B.S	—	
	Style		Honeycomb	—	
Compressor Capacitor		μF, VAC	—	50 μF, 370VAC	
Fan Motor Capacitor		μF, VAC	2.0 μF, 450VAC	3.0 μF, 450VAC	

- Specifications are subject to change without notice for further improvement.

4 Dimensions

CS-V28BKP5/ CU-V28BKP5

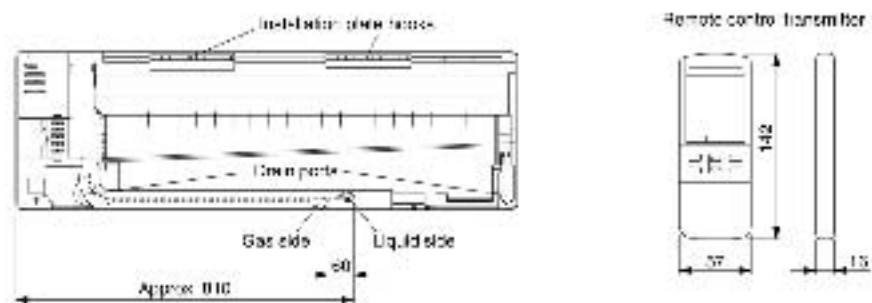
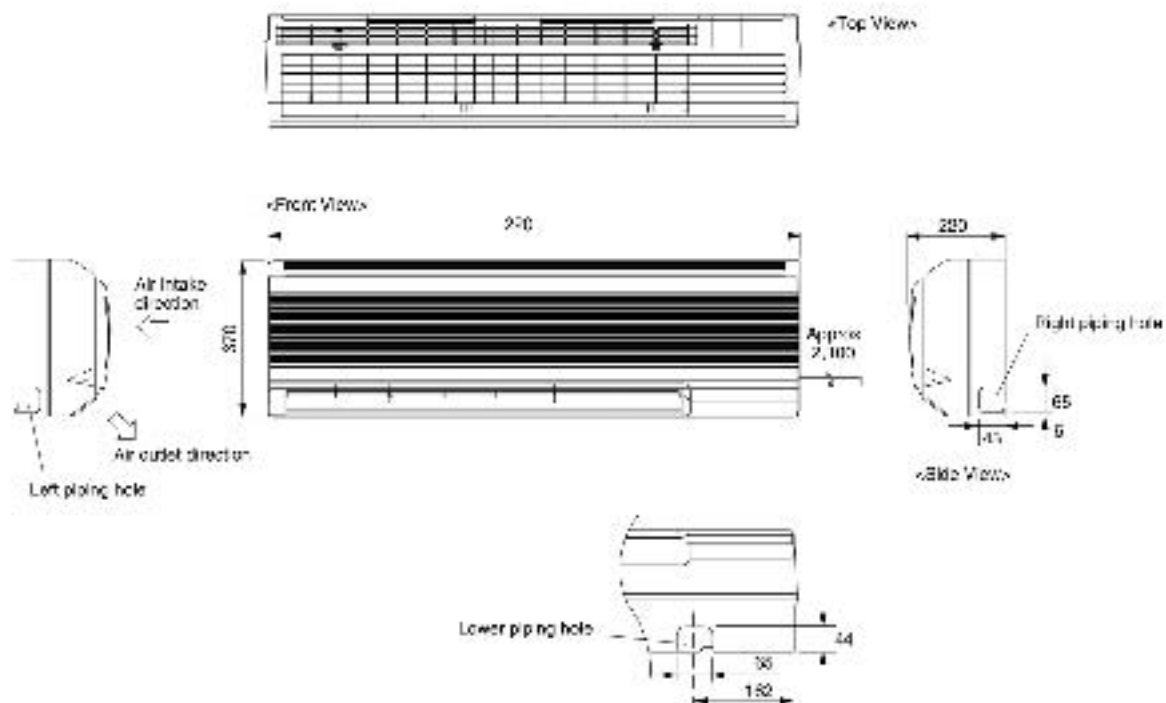

Relative position between the indoor unit and the installation plate (Front View)

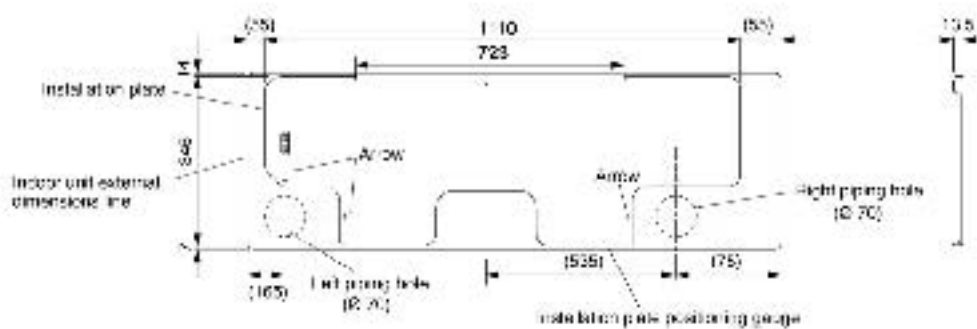

Unit : mm

6 Block Diagram

OUTDOOR UNIT

INDOOR UNIT

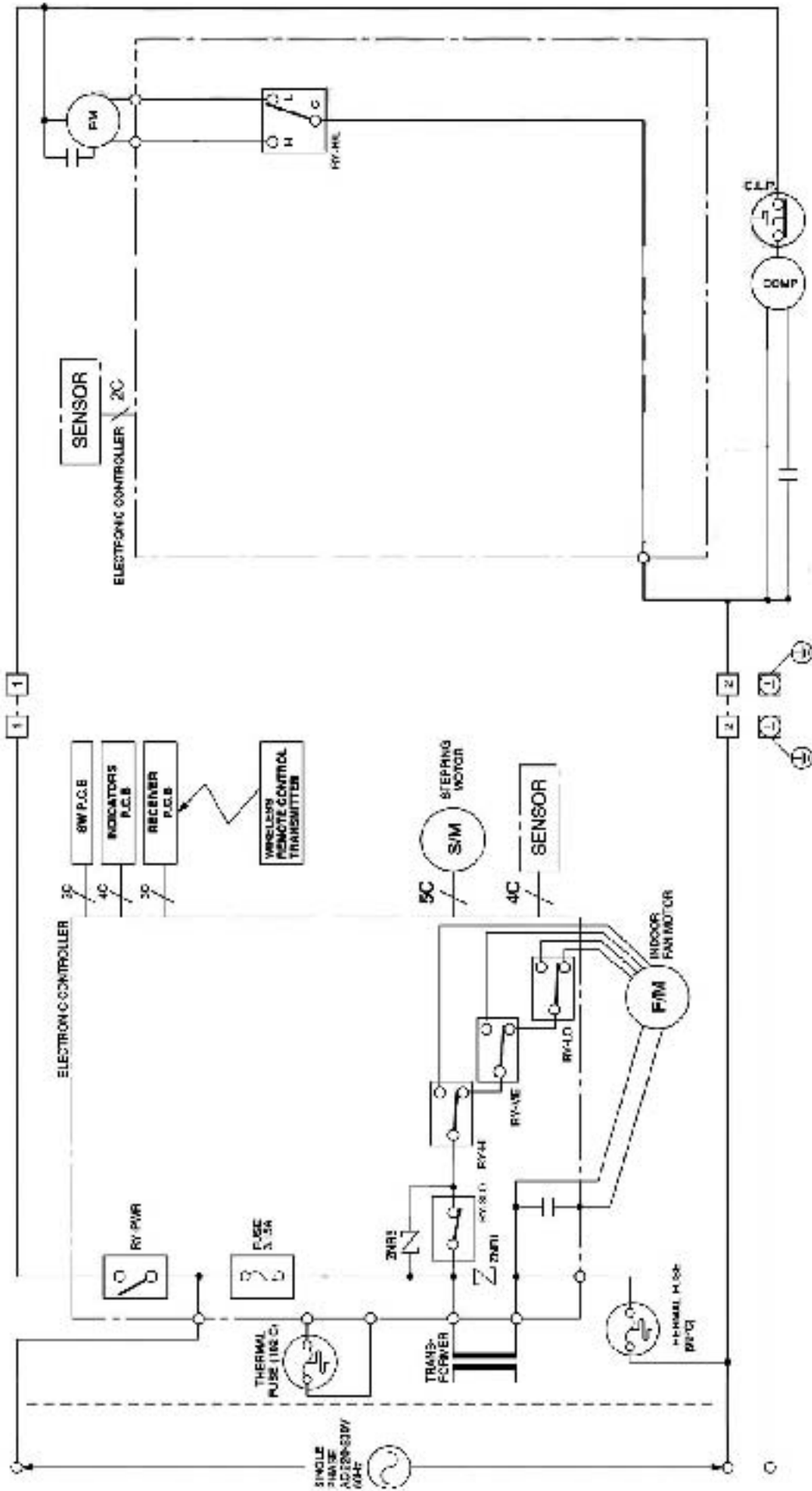

- ⊠ Indicates the electronic control unit.
- ⊠*C Indicates the number of core wires. (Example: 6C=6 core wires)

7 Wiring Diagram

CS-V28BKP5 / CU-V28BKP5

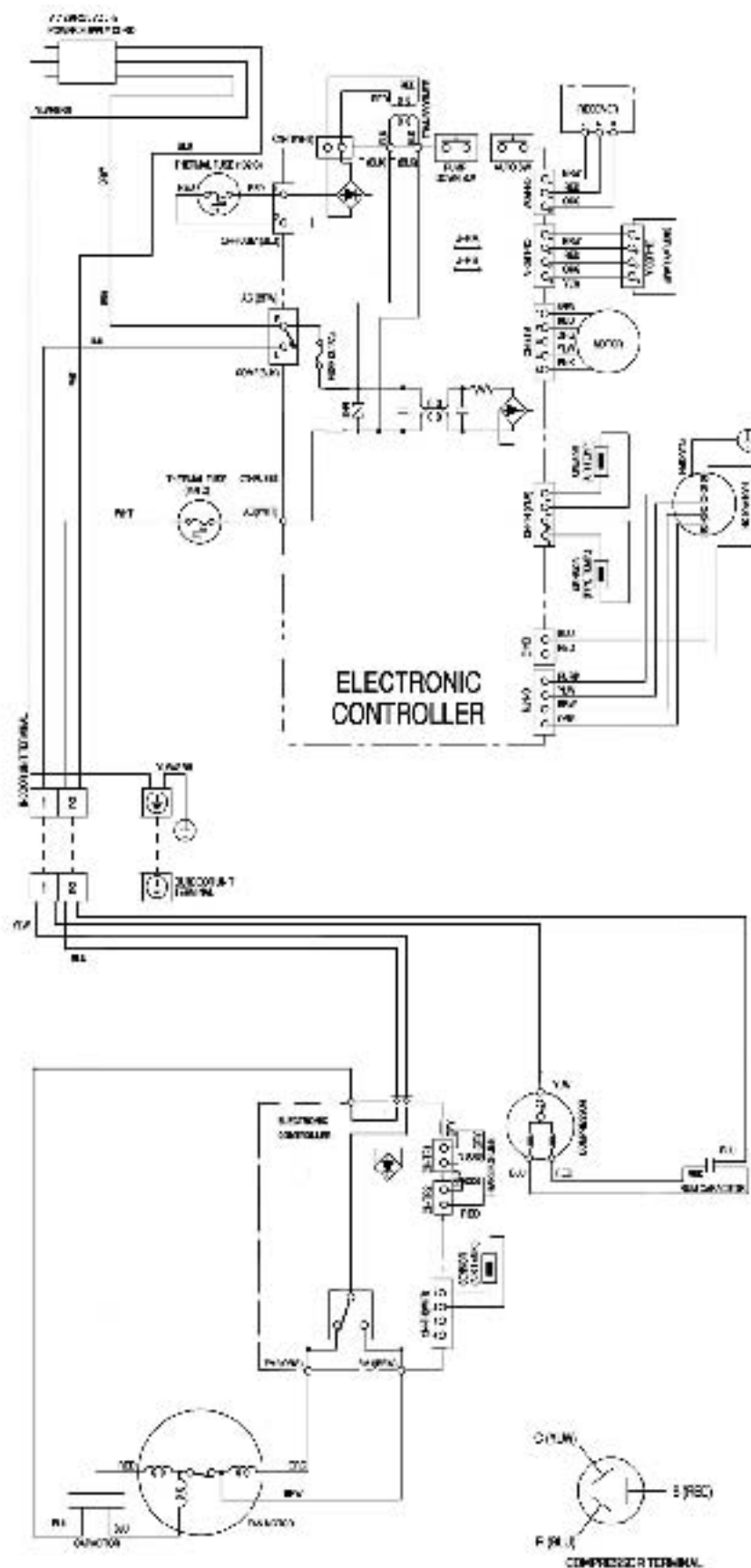

- Remarks:**
- BLU : BLUE
 - BRW : BROWN
 - BLK : BLACK
 - WHT : WHITE
 - RED : RED
 - ORG : ORANGE
 - PNK : PINK
 - YLW : YELLOW
 - GRN : GREEN
 - GRY : GRAY
 - VLV : VIOLET
 - PURP : PURPLE

Resistance of Indoor Fan Motor Windings

CONNECTION	CWC4301-370
BLUE - PURP	126.2
PURP - YLW	104.5
YLW - BRW	48.1
BRW - ORG	48.5
RED - PURP	181.0

Resistance of Outdoor Fan Motor Windings

CONNECTION	CWC4301-380
BLUE - BROWN	50.81
BROWN - ORANGE	34.3
RED - BROWN	92.4

Resistance of Compressor Windings

CONNECTION	ZR38K3EPFJ512
C - R	0.687 Ω
C - S	1.84 Ω

8 Operation Details

8.1. Cooling Mode Operation

Cooling in operation according to Remote Control setting.

Time Delay Safety Control (3 minutes)

- When the compressor is stopped by Power Switch, Remote Control or there is a power failure, it restarts after 3 minutes when the Power Switch, Remote Control is turned ON or the power supply is resumed.
- When the setting temperature is reached during cooling operation, the compressor stops and it will not start for 3 minutes.

7 minutes Time Saved Control

- The compressor will start automatically if it has stopped for 7 minutes even if the room temperature is below the compressor ON temperature.

Anti-Freezing Control

- If the temperature of the indoor heat exchanger falls continuously below 1°C for 4 minutes, the compressor turns off to protect the indoor heat exchanger from freezing. The fan speed setting remains the same.
- Compressor recommences when the indoor heat exchanger temperature rises to 10°C (Recovery).
 - ❖ 3 minutes waiting of Time Delay Safety Control is valid for Cooling Operation.

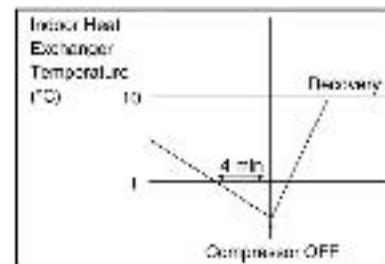

Automatic Fan Speed Mode

When Automatic Fan Speed is selected at Remote Control during cooling operation.

- Fan speed rotates in the range of Hi to Me.
- Deodorizing Control.

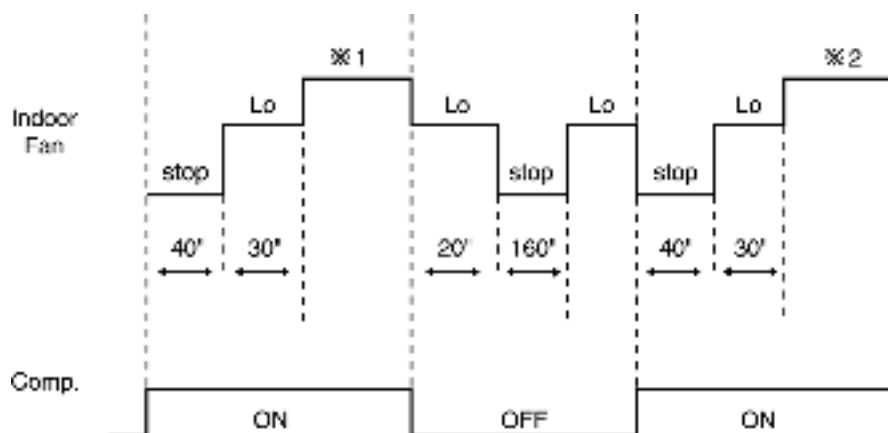

※ 1 Fan Speed is Hi until the compressor stops (when the room temperature reaches setting temperature).

※ 2 Fan Speed is Me after the compressor restarts.

Cooling Operation Time Diagram

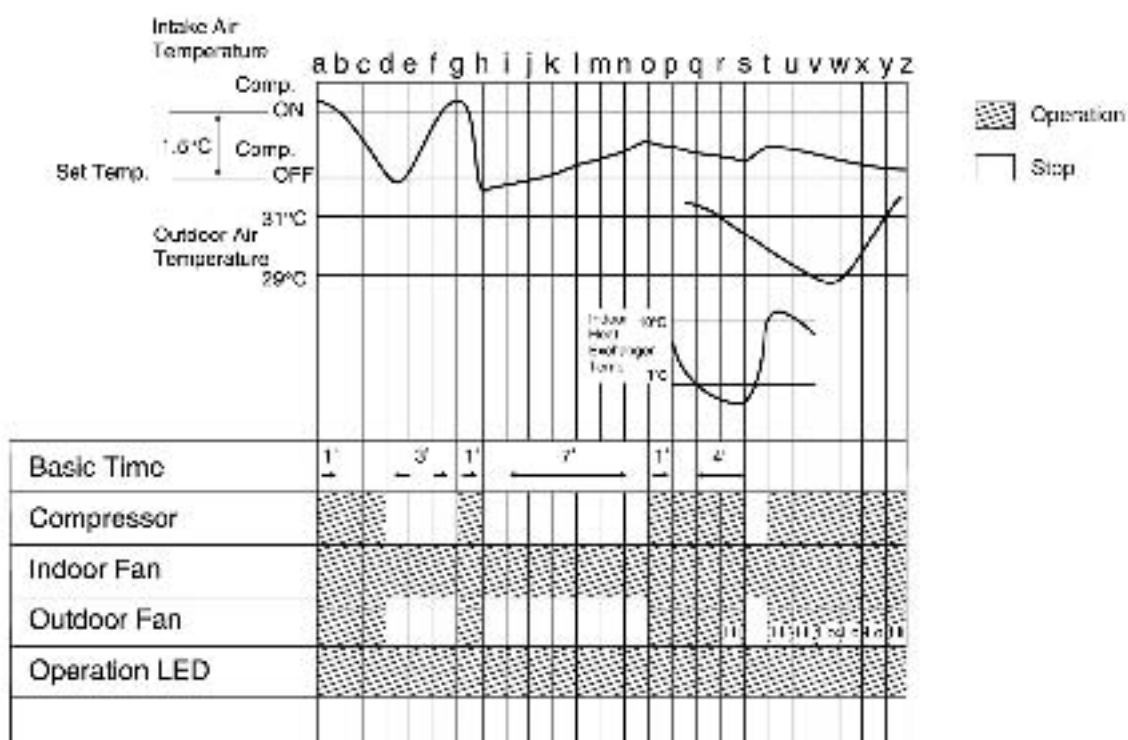

<Description of operation>

d - g : Time Delay Safety Control (waiting for 3 minutes)

g - h : 60 sec. Forced Operation

h - o : 7 min. Time Saved Control

q - t : Anti Freezing Control

v - y : Outdoor Fan Control

8.2. Soft Dry Mode Operation

- The unit starts cooling operation until the room temperature reaches the setting temperature set on the Remote Control, and then Soft Dry operation will start.
- During Soft Dry operation, the Indoor Fan operates with SLo speed.
- Once room temperature reaches below Soft Dry OFF temperature, Indoor Fan, Compressor and Outdoor Fan Stop for 6 minutes.

Time Delay Safety Control

- Once the compressor stops, it will not start for 3 minutes during Cooling operation.

Anti-Freezing Control

- Same as Anti-Freezing Control for Cooling Mode operation. (For Soft Dry region, 6 minutes waiting is valid during compressor stops.)

Automatic Fan Speed Mode

When Automatic Fan Speed is selected at Remote Control during Soft Dry operation.

- Fan speed rotates at SLo speed.
- Deodorizing Control.

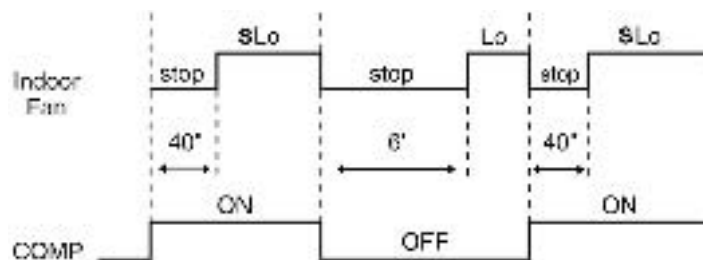

Soft Dry Operation Time Diagram

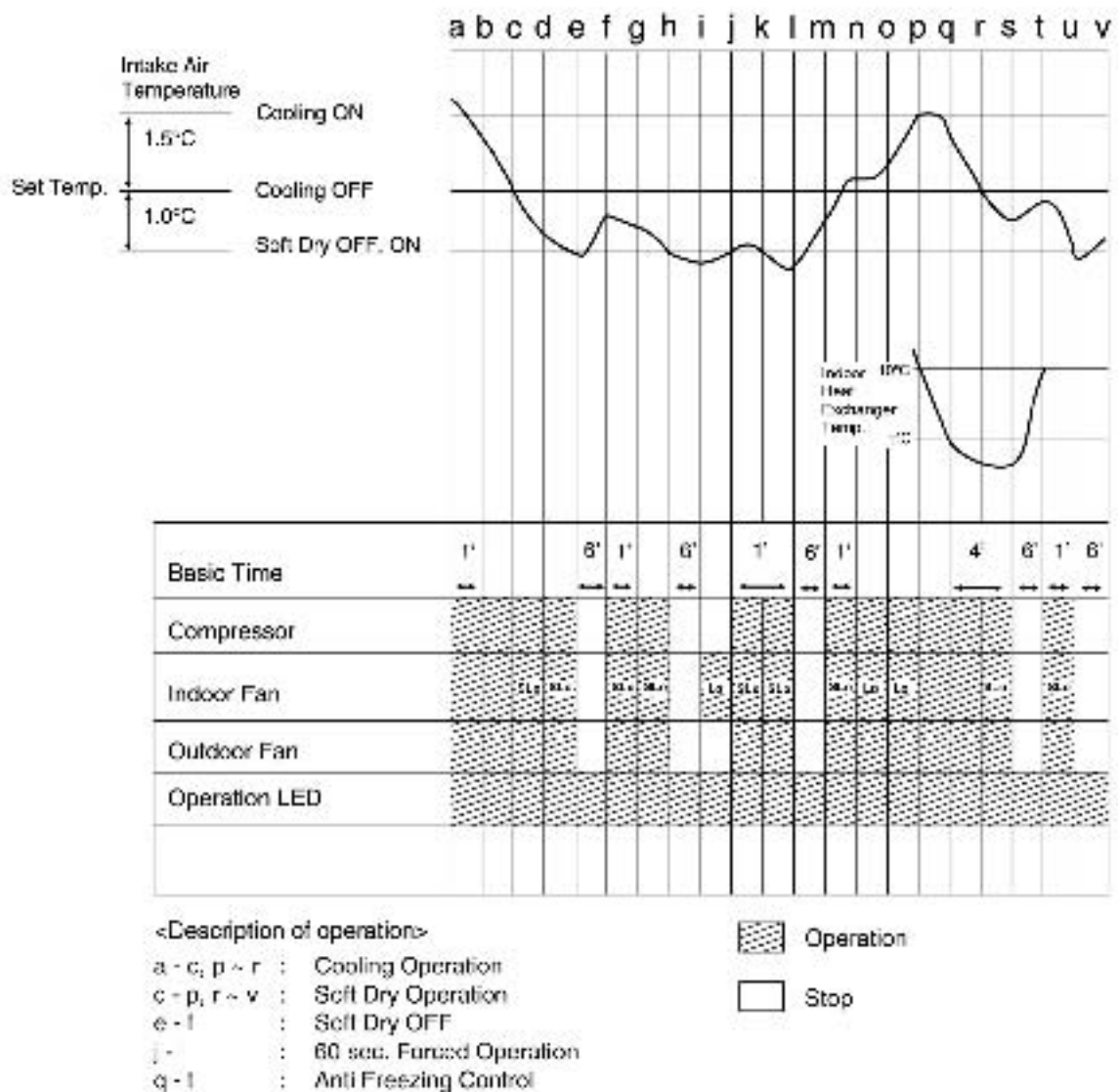

8.3. Automatic Mode Operation

1. When the Automatic Mode Operation is selected, the indoor fan operates at SLo fan speed for 20 seconds to sense intake air temperature and determine the 1st operation mode.

Standard for Determining Operation Mode Judgement

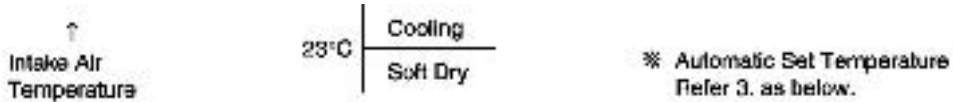

Note: Below setting is available by cutting jumper wire (J-TMP)

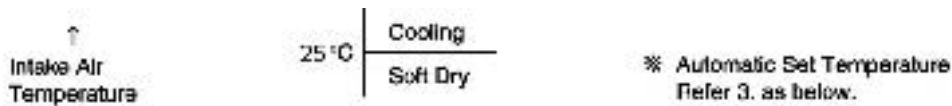

2. After judging operation mode will not shift. However during soft dry operation mode, cooling operation is available.

※ Automatic Set Temperature Refer 3. as below.

3. Automatic Set Temperature

For each operation, set temperature will automatically set as shown below.

However it can be selected 2°C higher or 2°C lower from standard set temperature by pressing the "Room Temperature Setting button".

* .As the J-TMP be cutted.

Operation Mode	Higher	Standard	Lower
	(+2°C)	(±0°C)	(-2°C)
Cooling	27°C	25°C	23°C
Soft Dry	24°C	22°C	20°C

Operation Mode	Higher	Standard	Lower
	(+2°C)	(±0°C)	(-2°C)
Cooling	29°C	27°C	25°C
Soft Dry	28°C	24°C	22°C

8.4. Sleep Mode Auto Operation

Cooling or Soft Dry Operation

When you press the SLEEP Mode, the following movement will start to avoid overcooling.

- The fan speed refer to Indoor Fan Motor Control.
- The setting temperature will be risen by **0.5°C** at the start of operation and by **0.5°C** one hour later.
- The operation will stop after **8 hours**.
- When using together with the Timer, the ON-Timer has priority.

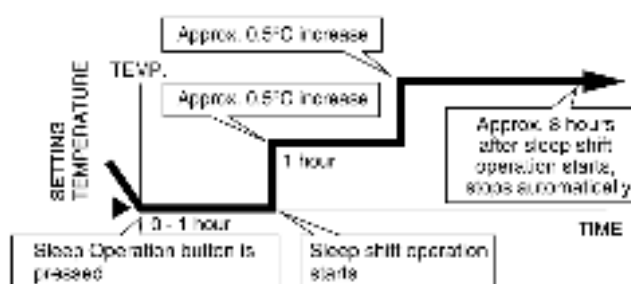

Fan Operation

- The fan speed refer to Indoor Fan Motor Control.
- The operation will stop after **8 hours**.
- When using together with the Timer, the ON-Timer has priority.

8.5. Auto Restart Control

- If there is a power failure, operation will be automatically restarted when the power is resumed. It will start with previous operation mode and airflow direction. (Time Delay Safety Control is valid)
- Auto Restart Control is not available when Timer or Sleep Mode is set.
- This control can be omitted by cutting the jumper wire J2. (Refer Circuit Diagram)

8.6. Indoor Fan Speed Control

- Auto Fan Speed Control

When set to Auto Fan Speed, the fan speed is adjusted between maximum and minimum setting as shown in the table.

- Manual Fan Speed Control

Basic fan speed adjustment (3 settings, from Lo to Hi) can be carried out by using the Fan Speed selection button.

Fan Speed		High Speed ←→ Low Speed						
Cooling	Manual	○	○	○				
	Auto	○	○	○				○
	Sleep			○				
Soft Dry	Manual, Auto			○	○			○
	Sleep			○				
Fan	Manual			○				
	Auto			○				○
		Hi	Me	Lo	SLo			STOP

8.7. Airflow Direction Control

Airflow Direction Auto-Control

- When set a Airflow Direction Auto-Control with remote control, the louver swings up and down as shown in the diagram.
- The louver does not swing when the Indoor Fan stops during operation.
- When stopped with remote control, the discharge vent is closed with the louver.

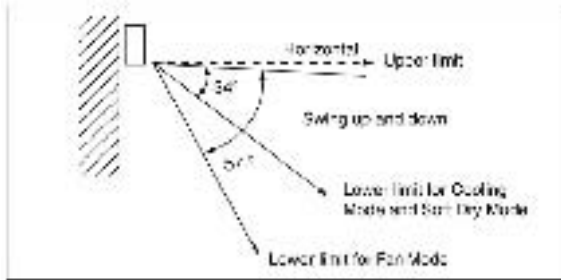

- ❖ The left and right airflow direction louvers can be adjusted manually.
- ❖ 1 There is no swinging while indoor fan is stopped during Cooling and Soft Dry operation.

Airflow Direction Manual Control

- When the airflow direction set button is pressed, the automatic airflow is released and the airflow direction louver move up and down in the range shown in the diagram. The louver can be stopped by releasing the button at the desired louver position.
- When the remote control is used to stop the operation, the discharge vent is closed with airflow direction louver.

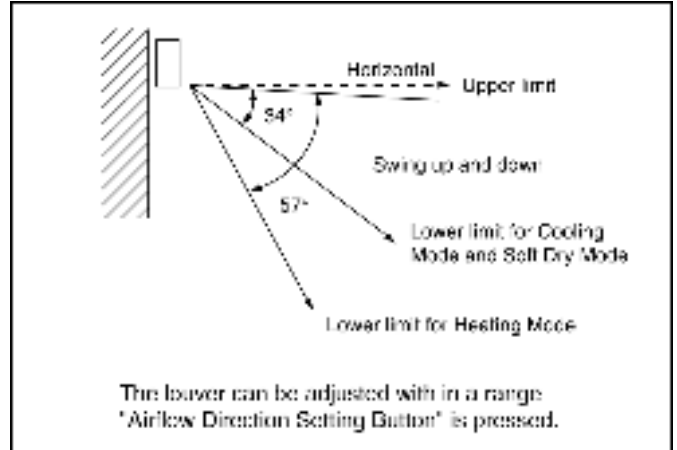

- ❖ The left and right airflow direction louvers can be adjusted manually.

8.8. Delay ON Timer Control

- When the Delayed ON Timer is set by using the remote control, the unit will start operate slightly before the set time, so that the room will reach nearly to the set temperature by the desired time.
- For Cooling and Soft Dry mode, the operation will start 15 minutes before the set time.
- For Automatic mode, the indoor fan will operate at SLo speed for 20 seconds, 15 minutes before the set time to detect the intake air temperature to determine the operation mode. The operation indication lamp will blink at this time.

9 Operating Instructions

Safety Precautions

Before operating, please read the following “Safety Precautions” carefully.

To prevent personal injury, injury to others and property damage, the following instructions must be followed.

- Incorrect operation due to ignoring of instructions will cause harm or damage, the seriousness of which is classified as follows :



Warning : This sign warns of death or serious injury.



Caution : This sign warns of injury or damage to property only.

- The instructions to be followed are classified by the following symbols :



This symbol (with a white background) denotes an action that is PROHIBITED.



These symbols (with a black background) denote an action that is COMPULSORY.

Installation precautions



Warning

- **Do not install, remove and reinstall the unit yourself.**
Improper installation will cause leakage, electric shock or fire. Please consult an authorized dealer or specialist for the installation work.



Caution

- **This room air conditioner must be earthed.**
Improper grounding could cause electric shock.
- **Ensure that drainage piping is connected properly.**
Otherwise, water will leak out.
- **Do not install the unit in a place where there may be explosive gas leaks.**
Gas leaks near the unit could cause fires.

Operation precautions



■ **Insert the power plug properly.**

Heat generated by a loose power plug could cause electric shock or fire. Electrical outlet and power plug shall be easily accessible.

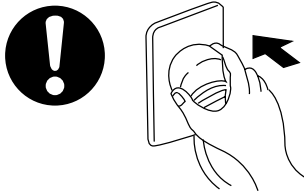

■ **Do not operate or stop the unit by inserting or pulling out the power plug.**

It could cause electric shock or fire.

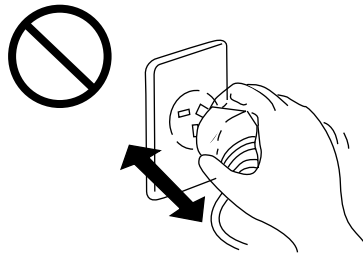

■ **Do not damage or use an unspecified power cord.**

It will cause electrical shock or fire.

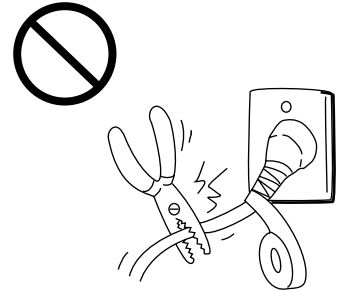

■ **Do not modify the length of the power cord or use an extension cord.**

It could cause electric shock or fire.



■ **Do not operate the unit with wet hands.**

It could cause an electric shock.



■ **Do not insert finger, sticks or other objects into the units.**

It could lead to physical injury and cause damage to the units.



■ **Do not be directly exposed to the cold airstream for too long.**

It could lead to health problems.

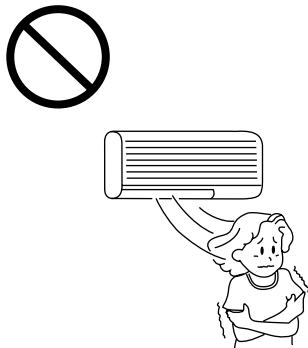

■ **If there is a smell of burning, stop the air conditioner and disconnect the power supply.**

The heat generated could cause electric shock or fire. Please consult an authorized dealer or service centre.

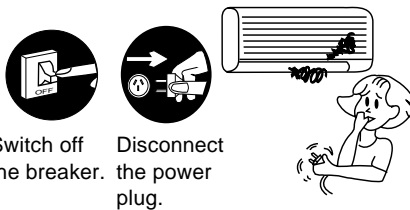

Switch off the breaker.

Disconnect the power plug.

■ **Do not try to repair the unit yourself.**

It could lead to fire or cause an electric shock. Please call an authorized dealer or service centre.

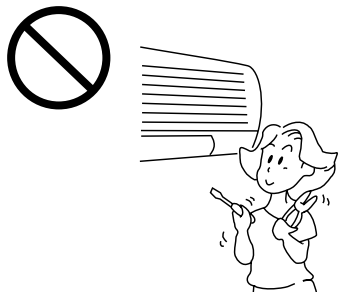



Caution

- **Do not remove the power plug by pulling the cord.**

Hold the plug when disconnecting the plug from the wall outlet.

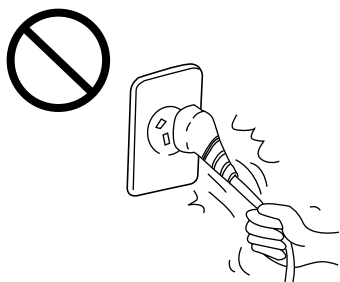

- **Switch off the power supply if the unit is not going to be used for a long period of time.**

If dust accumulates on the plug, it will generate heat and this could cause a fire.

Switch off the breaker.



Disconnect the power plug.

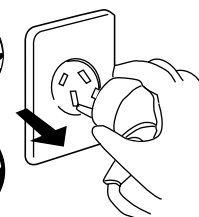

- **When cleaning the unit, remove the plug.**

This is to prevent injury due to the rotating fan in the unit.

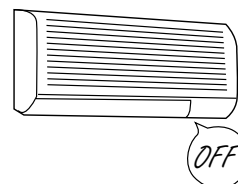

- **Do not use for other purposes.**

Do not use for preservation purposes. It will affect food quality, animals or plants.

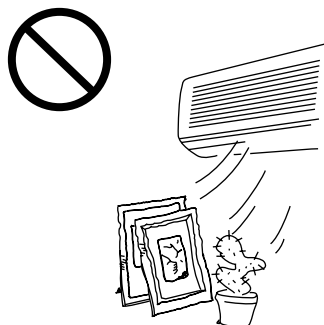

- **Do not place combustor in the path of the airflow from the unit.**

Incomplete combustion could cause toxic gas (CO) poisoning.



- **Ventilate the room regularly.**

If not ventilated regularly, the lack of oxygen could cause headaches.



- **Do not wash the unit with water.**

It could cause an electric shock.



- **Inspect the unit for any damage.**

Ensure that the necessary repairs are carried out.

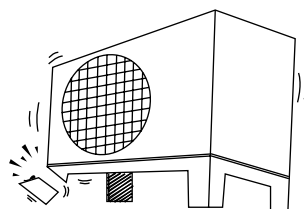

- **Do not sit or place anything on the outdoor unit.**

You might fall off or the unit might collapse.

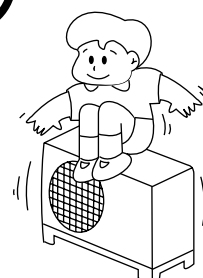

Name of Each Part

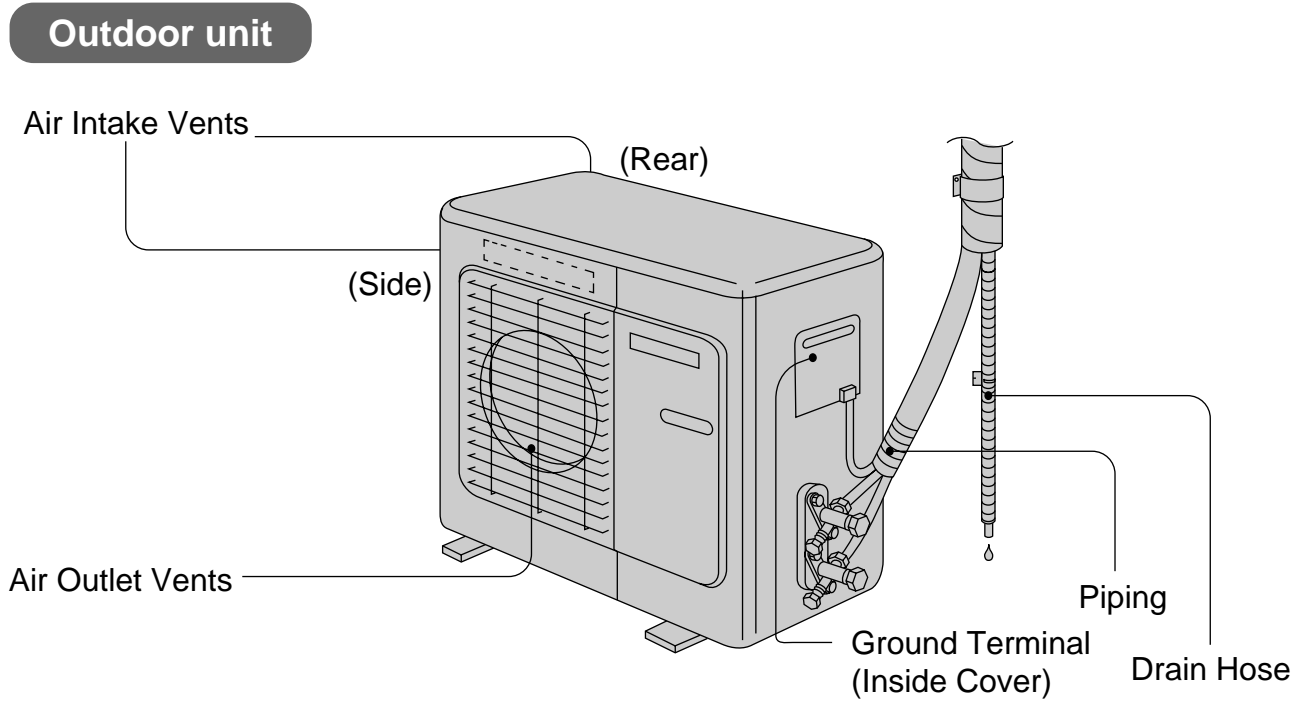
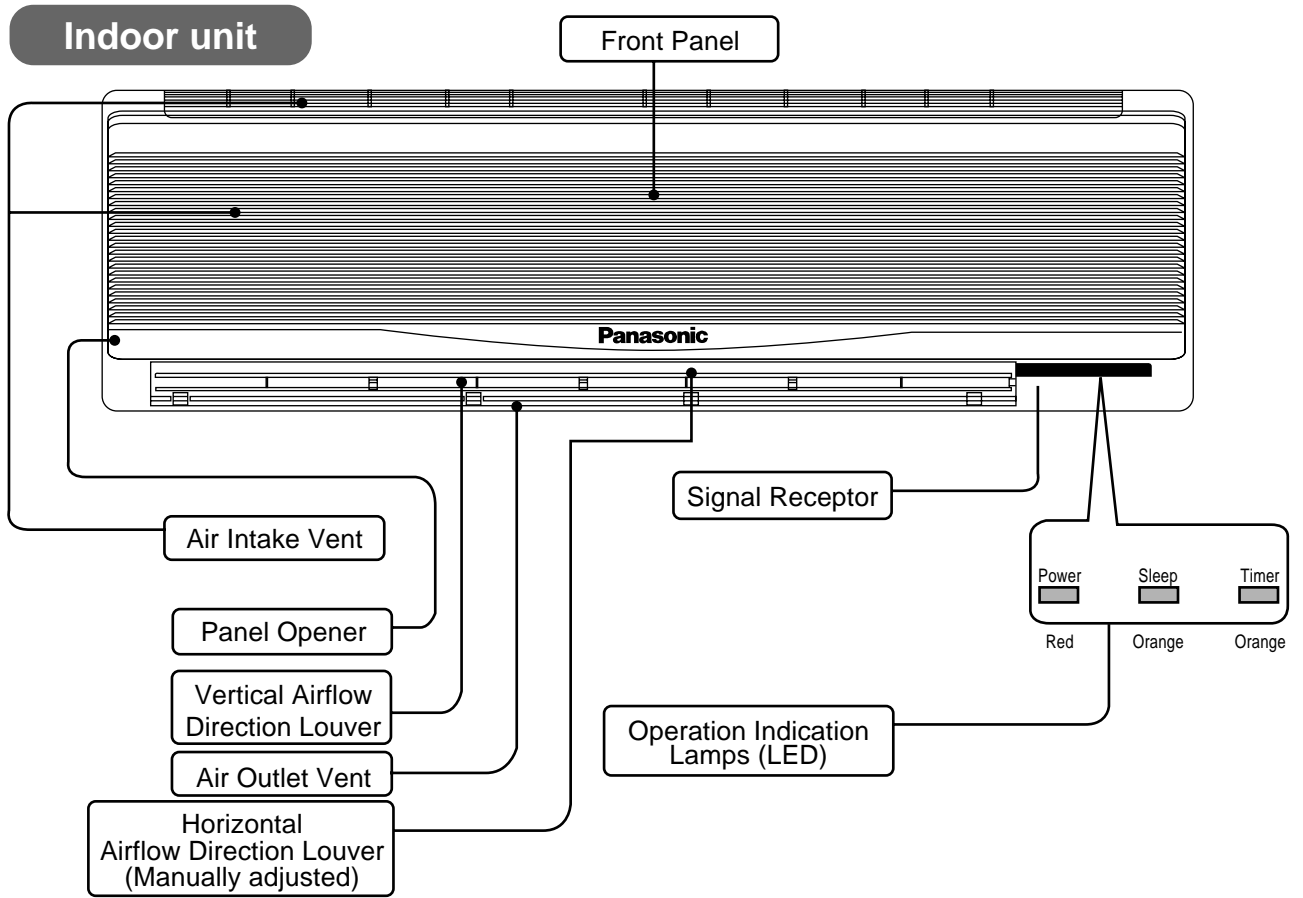

Remote control

Accessories

Remote Control



Two R03 dry-cell batteries or equivalent

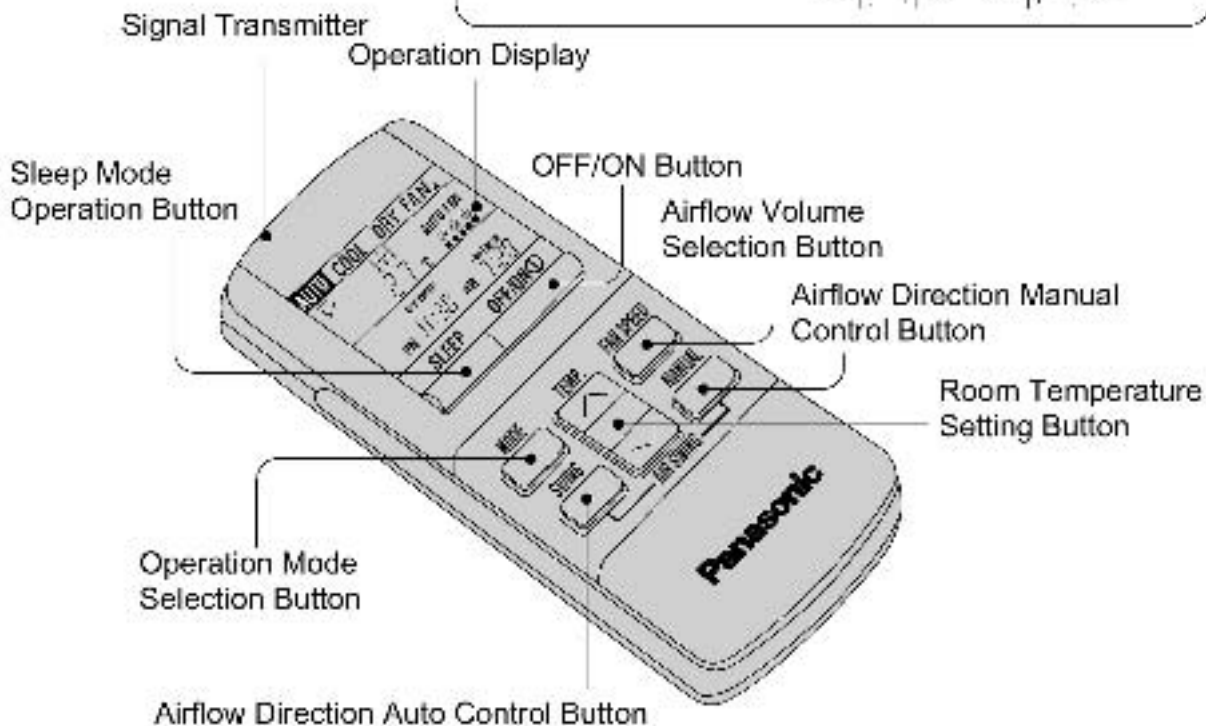

Air Purifying Filters (with deodorizing function)

Separate displays and functions are available when the door is opened.

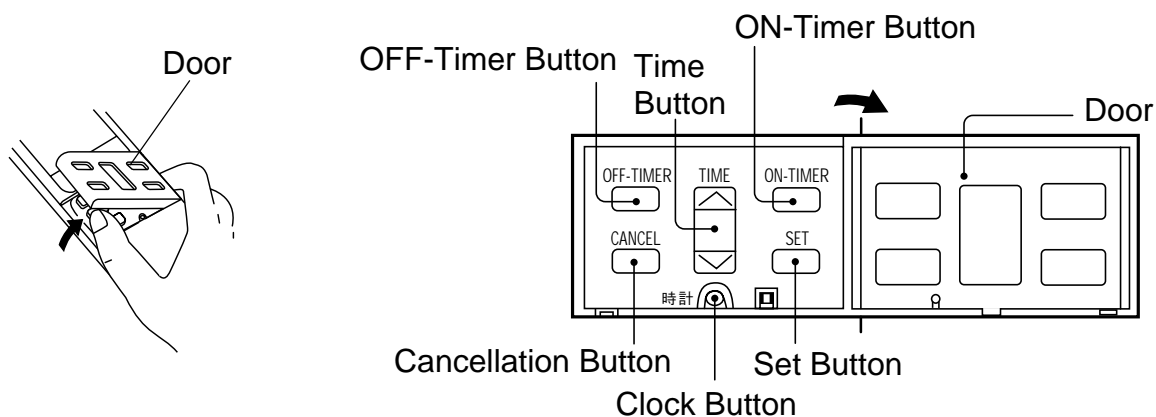

Preparation Before Operation

Before operating the unit

1

■ Connect the power supply cord to an independent power supply.

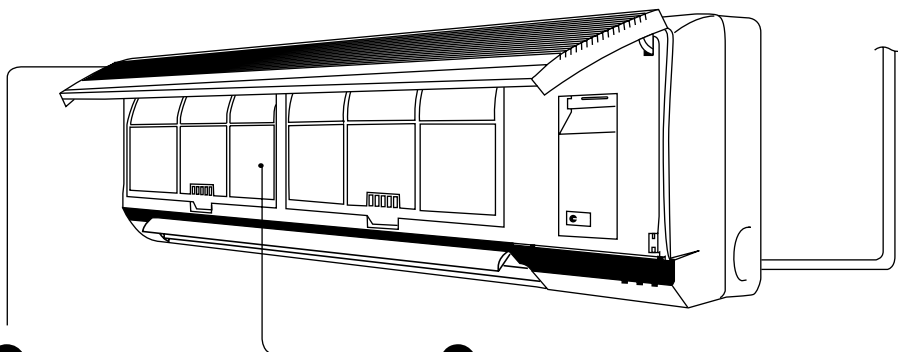

2

■ Open the front panel.

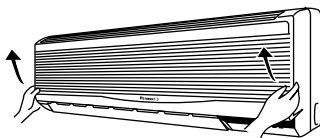

Hold the panel openers at both sides and pull up the front panel.

3

■ Remove air filter.

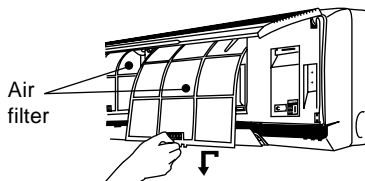

Hold the tab to raise up slightly and then pull down.

■ Insert air purifying filter.
Insert the air filters.



Be careful not to hurt your hands by metal parts.

Air purifying filter

<Note>

Use under the following conditions :

(Unit in °C)

	Cooling			
	Indoor		Outdoor	
DBT : Dry Bulb Temperature	DBT	WBT	DBT	WBT
Maximum Temperature	32	23	43	26
Minimum Temperature	16	11	16	11

How to insert batteries

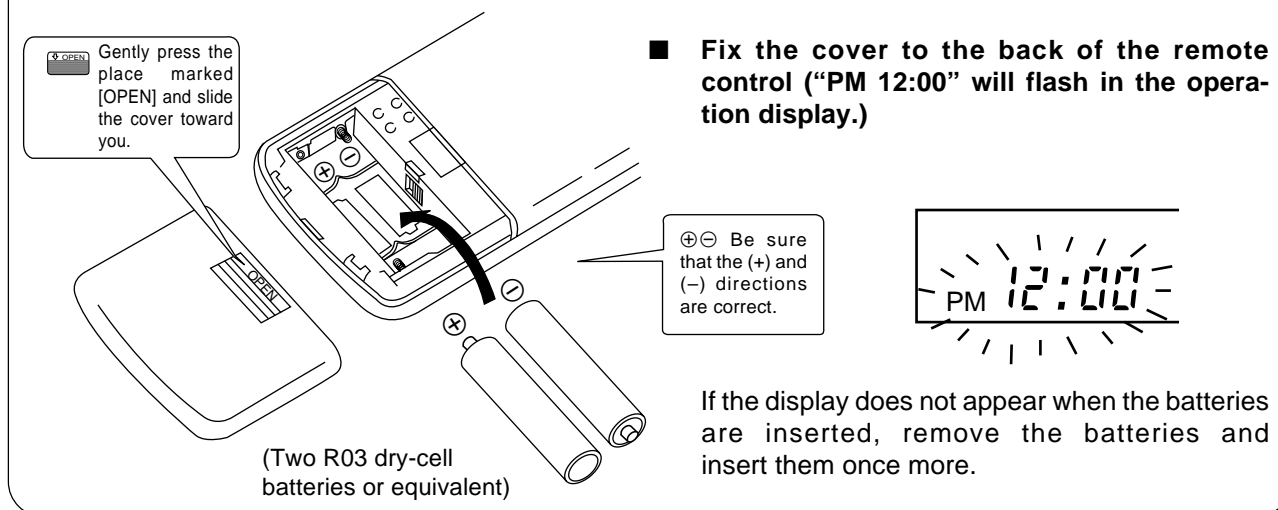

- Fix the cover to the back of the remote control ("PM 12:00" will flash in the operation display.)

Operating the remote control

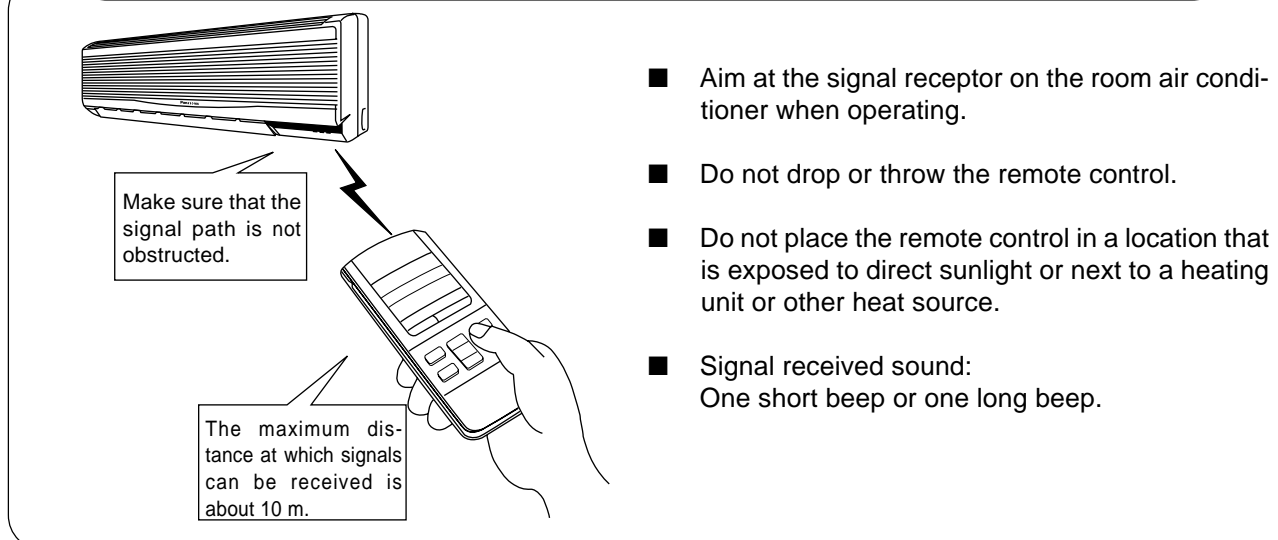

Pull out the power plug or turn off the power breaker when:

- **The air conditioner is not going to be used for an extended period of time.**

If the power switch is left at (ON), approximately 3.25 watts of electric power are used even if the main unit is turned off by remote control.

- **There is a danger of lightning.**

The air conditioner is provided with a built-in protective device, but the control equipment may be adversely affected depending on the extent of lightning activity.

Regarding the batteries.

- The batteries can be used for approximately one year.
- Do not use rechargeable (Ni-Cd) batteries, because such batteries differ from standard dry-cell batteries in shape, dimensions and performance.
- Be sure to replace the batteries with two new batteries of the same type.
- Do not dispose of empty batteries in household waste. Take them to special local collection sites.

How to Operate

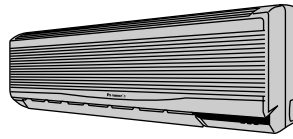

Auto Restart Control.

- If there is a power failure, operation will be automatically restarted after 3 minutes when the power is resumed with previous operation mode and airflow direction. (When the operation is not stopped by remote control.)

- If you do not intend to continue the operation when the power is resumed, pull out the power plug at main unit or power supply.

When you switch on the power switch, the operation will be automatically restarted with previous operation mode and airflow direction.

- Note:**
1. If you do not require Auto Restart Control, please consult your dealer.
 2. Auto Restart Control is not available when Timer or Sleep Mode is set.

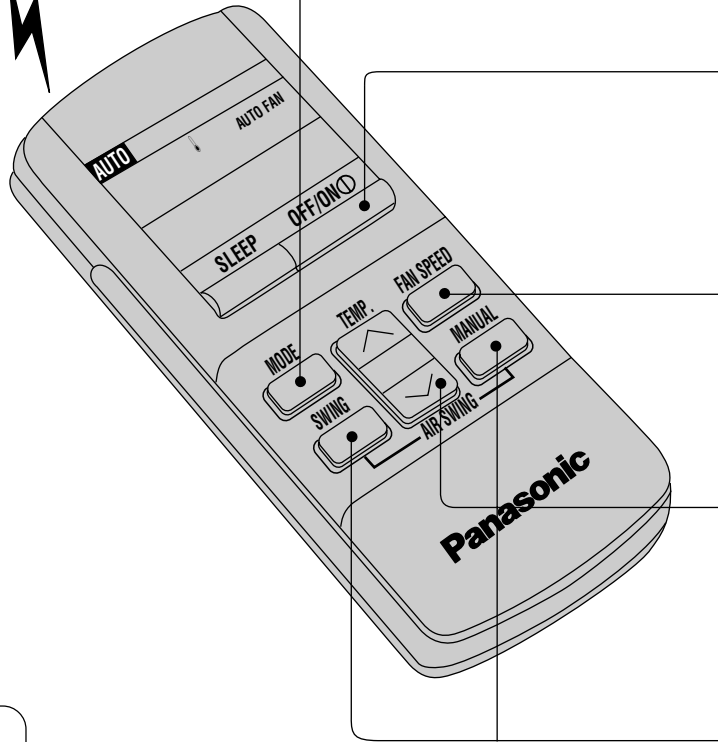

Recommended temperature for health and comfort.

For Cooling : 26°C – 28°C
 For Soft Dry : 1°C – 2°C lower than room temperature.

<Operation Details>









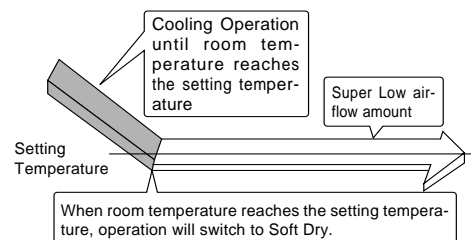

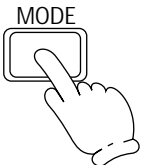

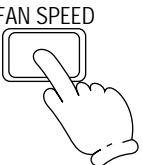

AUTO – Automatic Operation.

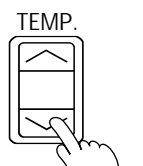
- Once the Automatic Operation is selected, the indoor temperature sensor operates automatically to select the desired operation mode with Cooling, Soft Dry .
- The operation mode changes every hour, when necessary.

DRY – Soft Dry Operation.

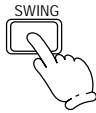
- Soft Dry is a very gentle Cooling Operation consisting primarily of dehumidifying. It does not lower the room temperature very much.



1		<p>Press to select operation mode.</p> <ul style="list-style-type: none"> The display changes in the order <p>AUTO → COOL → DRY → FAN</p> <p>each time the button is pressed.</p>
2		<p>Press to start the operation.</p> <ul style="list-style-type: none"> Operation indication lamp (RED) will light up. Press once more, to stop the operation.
3		<p>Press to select airflow volume.</p> <ul style="list-style-type: none"> The display changes in the order. <p>AUTO FAN →  →  → </p> <p>Automatic Low Medium High</p>
4		<p>Press to select room temperature.</p> <ul style="list-style-type: none"> Heating, Cooling, Soft Dry – Select temperature as desired. (16°C ~ 30°C) Automatic. <p> 2°C lower than standard  standard  2°C higher than standard</p>
5	 	<p>Press  continuously.</p> <ul style="list-style-type: none"> The vertical airflow direction louver will move up and down. Release the button when the louver is at the desired position. <p>Press .</p> <ul style="list-style-type: none"> The vertical airflow direction louver will swing up and down automatically. <p>To stop the automatic airflow direction operation, press  button.</p>

FAN – Air Circulation Operation

- When the room temperature reaches the setting temperature, operation commences at Low air-flow volume. It stops when the room temperature drops to 2°C below the setting temperature (It is useful when using a heater)

Automatic Airflow Volume

- The speed of the indoor fan is adjusted automatically according to the operation. The indoor fan stops occasionally during cooling operation.

Range of louver adjustment

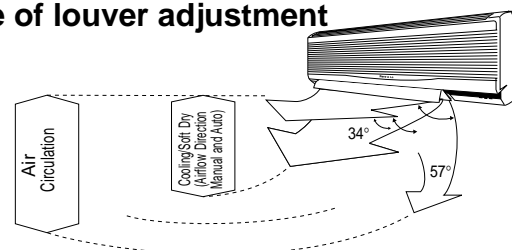

Setting the Timer

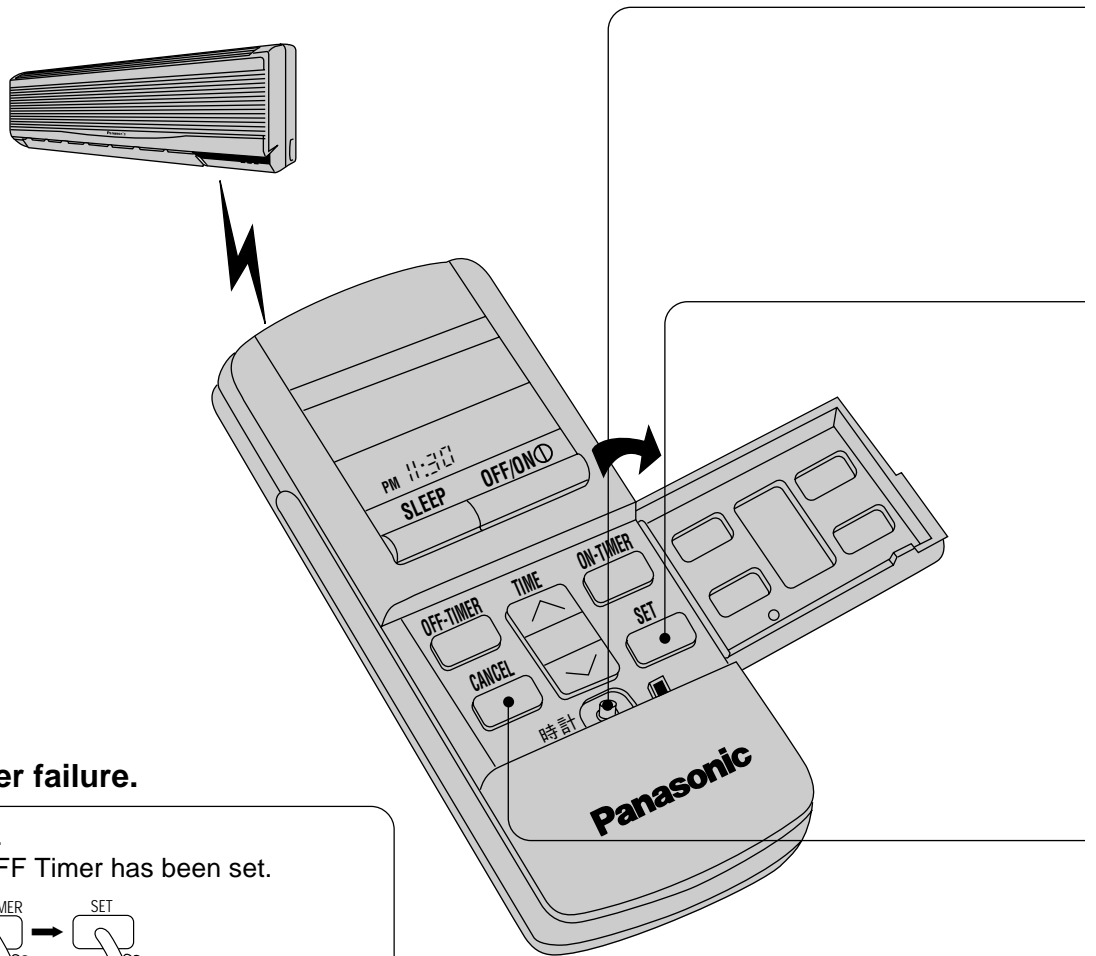

If there is a power failure.

To reset the Timer.
(Example) If the OFF Timer has been set.

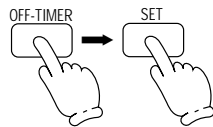

- Even if there is a power failure, the setting time is still stored in the memory because the remote control is a battery operated type.

<Note>

Regarding remote control.

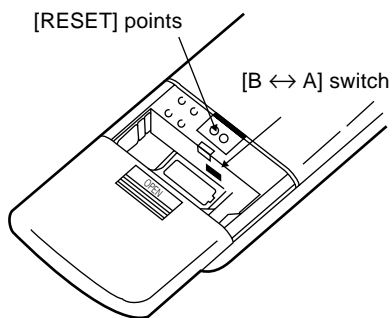

- If the current time is not set correctly, correct Timer setting will not be possible.
- When the Timer is set, the current time display will vanish.
- [RESET] points will clear the memory once they are shorted.
- [B ↔ A] switch is used when two air conditioners units have been installed in one room. Please consult your dealer.

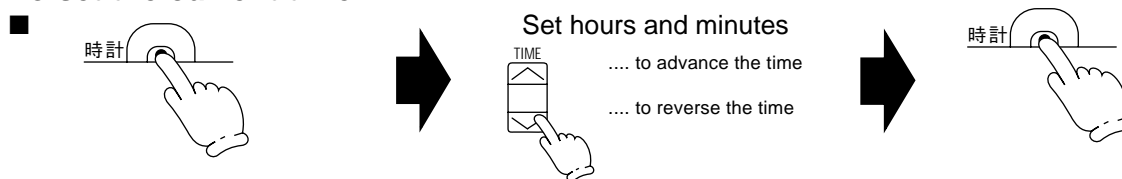
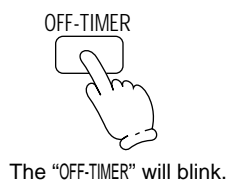
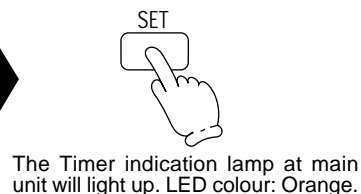
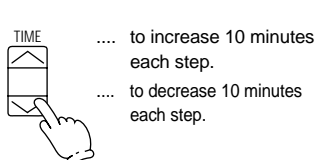
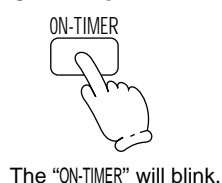
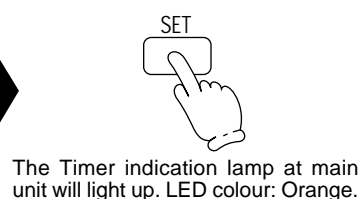
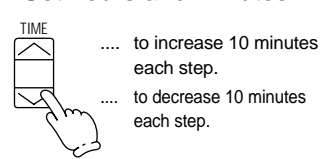
To set the current time.**To set the Timer.****OFF Timer****Set hours and minutes****ON Timer****Set hours and minutes****To cancel the Timer.****OFF Timer**

- The Timer indication lamp at main unit will go off.
- To cancel the ON Timer, follow the same procedure.

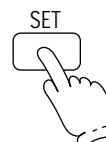
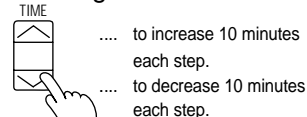
To change the Timer setting time.**(Example) To change the ON Timer setting time.****Change hours and minutes setting****Timer**

- The ON Timer and OFF Timer can only be set once during a day.
- The operation will start before the actual setting time with ON Timer setting.

Cooling and Soft Dry : 15 minutes before

This is to allow time to attain your desired set temperature.

Setting the OFF Timer.

This is useful for saving electricity costs incurred by forgetting to turn off the air conditioner.

Setting the ON Timer.

If the air conditioner is set before you go out, the room temperature will be close to your desired temperature when you return.

Convenient Operation

Sleep Mode

This is to gain a comfortable room temperature while sleeping.

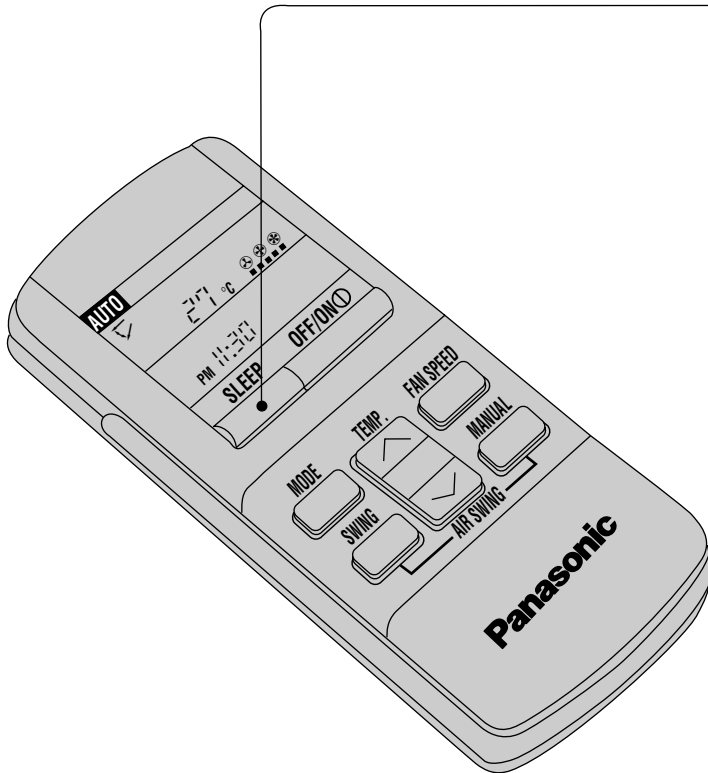

To set Sleep Mode.

- Press



(The sleep indication lamp on the main unit will light up.)

To cancel Sleep Mode.

- Press once more



(The sleep indication lamp on the main unit will switch off.)

Sleep Mode Operation.

- When the room temperature reaches the setting temperature or after 1 hour of operation, sleep shift operation starts and the airflow volume will automatically change to low.
- Sleep Mode Operation time is 8 hours.
- When using together with the Timer, the Timer has priority.

<Information>

- Cooling or Soft Dry Operation for Sleep Mode movement will start to avoid overcooling.

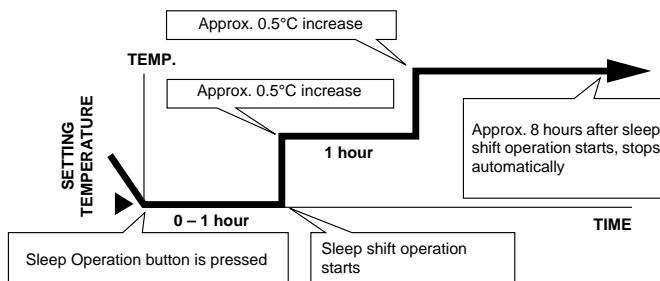

When the remote control cannot be used

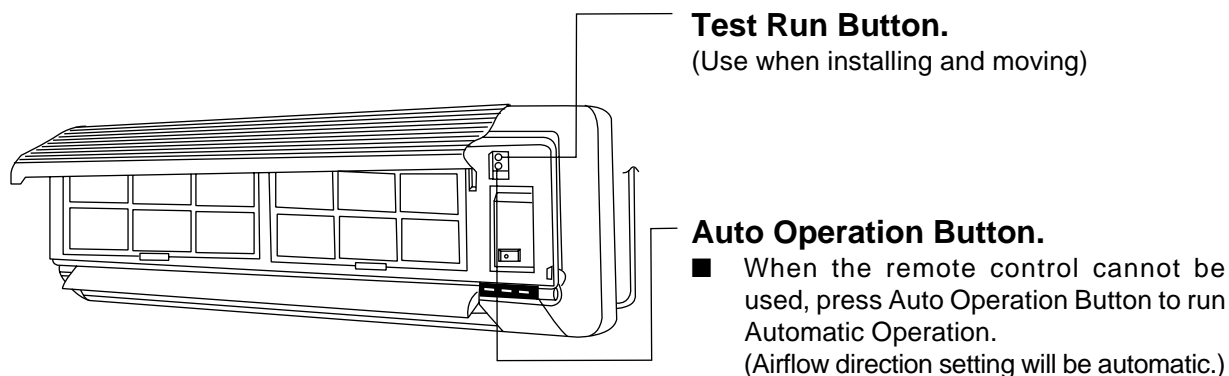

- **Press Auto Operation Button.**
(The operation indication lamp will blink for 20 seconds, and then light up)
 - If the button is pressed once more, the air conditioner will stop.
(The operation indication lamp will switch off.)



OFF/ON remote control signal receiving sound

- The Remote Control Signal receiving sound can be omitted as desired.
- To switch OFF the signal receiving sound, press Auto Operation Button for 10 seconds or more. At the same time, Automatic Operation starts.
(To switch ON, press Auto Operation Button once more for 10 seconds or more.)

Operation Hints

- Adjust room temperature properly. Set the temperature 1°C higher than actually desired. Approximately 10% of electricity of electricity costs can be saved.

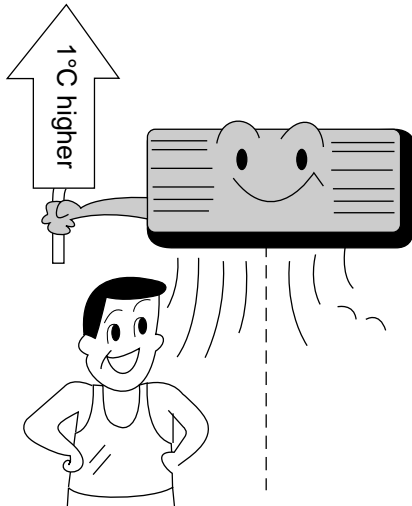

- Clean the air filter regularly. Blockage in the air filter reduces the airflow and lowers the cooling or heating. Clean at least once every 2 weeks. Otherwise, about 6% of electricity cost will be wasted.

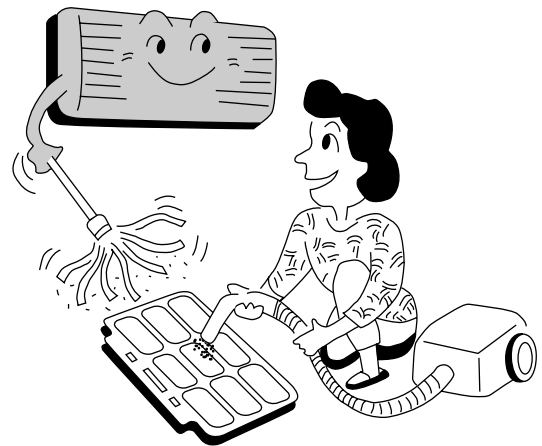

- Prevent wastage with the Timer. Use Timer when sleeping or going out to save electricity cost.

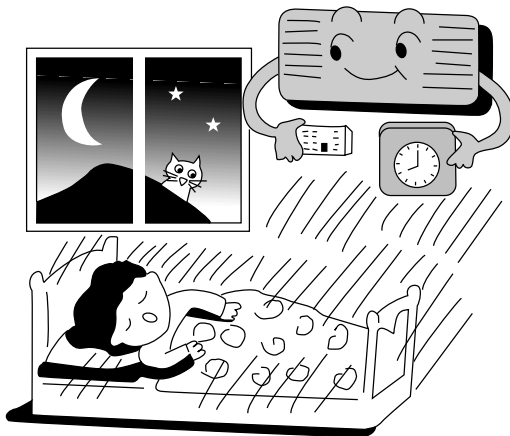

- Do not block the air outlet vents at outdoor unit. Otherwise, it will lower the cooling or heating performance.

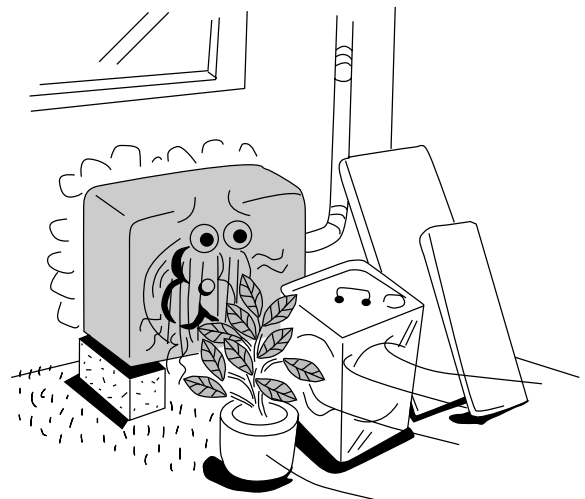

- Make sure that the doors and windows are shut. Otherwise, cooling and heating performance will be reduced and electricity cost is wasted.

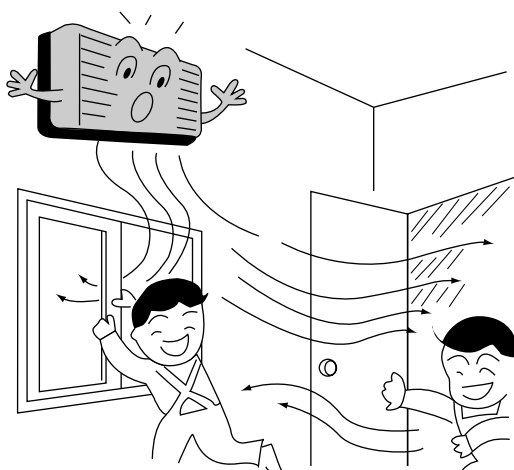

- Keep blinds or curtains closed. Do not let sunshine enter the room directly. About 5% of electricity cost can be saved.

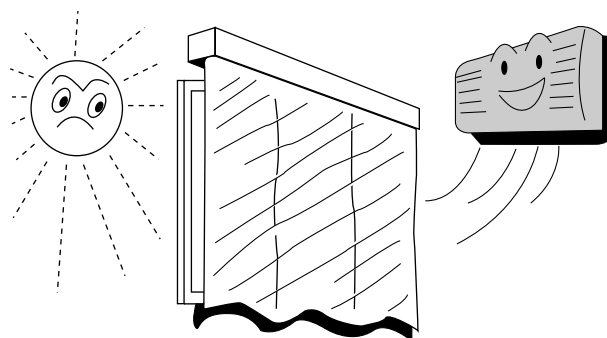

- Proper airflow direction adjustment. Set the airflow direction louvers horizontal for Cooling Operation. Operation result will be better.

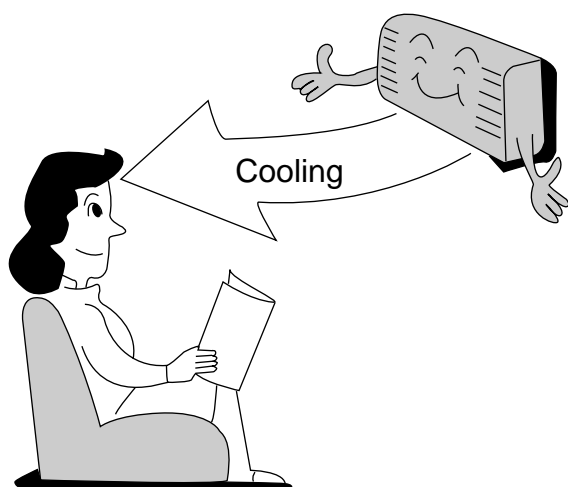

- Use insulating material for better performance. Use insulating material during construction or renovations. It will save electricity cost.

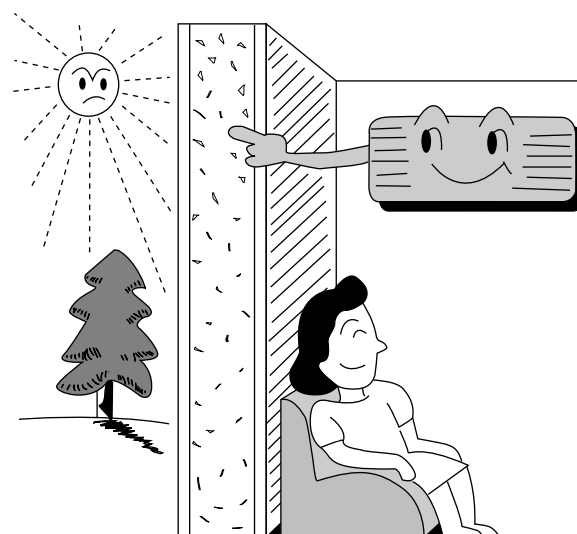

Better Care and Maintenance

Regular care and maintenance will extend the life of the air conditioner and prevent wastage of electricity. Before performing any maintenance procedure, be sure to switch off the main power supply.

Caution



Do not use water or volatile liquids.

- Do not make air conditioner wet, as there is the danger that it could cause electric shocks.
Be sure not to apply water when cleaning or at any other time.
- Using water above 40°C could cause deformation and/or discolouration.
- Volatile liquids such as thinner or benzene may damage the air conditioner.

Cleaning the air conditioner and air filters

Once every 2 weeks is recommended.

■ Clean the air conditioner.

Wipe gently with a soft, dry cloth.

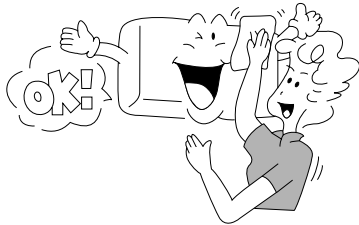

■ Clean the air filters.

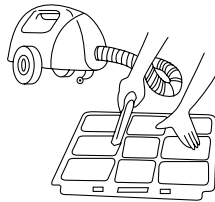

- To remove the dust adhering to the filters, either use a vacuum cleaner, or wash them in water and dry in the shade.
- Re-insert the filters correctly at the left and right, with the side marked [FRONT] facing forward.
- Purchase replacement filters from your air conditioner dealer if the air filters become damage.

Air Filter No. CWD4209540 (right)
CWD4209550 (left)

Replacement of air purifying filters

1 Remove the air filters.

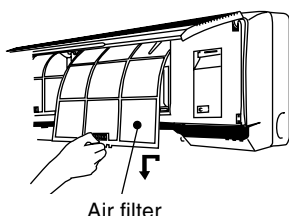

2 Remove the air purifying filters.

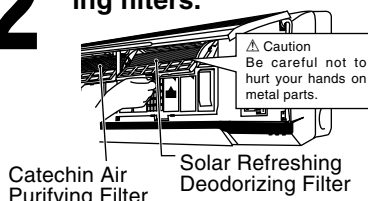

3 Remove the filters from the filter frame.

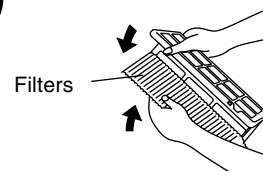

<Note>

- Solar Refreshing Deodorizing Filter**
 - Used to remove unpleasant odour and deodorize the air in the room.
 - Reusable.
 - Vacuum, place under direct sunlight for 6 hours and fit it back in place. (Recommended : every 6 months)
- Catechin Air Purifying Filter**
 - The filter is coated with catechin to prevent growth of bacteria and viruses.
 - Reusable.
 - Vacuum and fit it back in place (Recommended : every 6 months)
- Recommended to change these filters every 3 years.** Do not reuse damaged filters. Consult the nearest authorized dealer to purchase a new filter. Catechin Air Purifying Filter No.: CZ-SF71P
Solar Refreshing Deodorizing Filter No.: CZ-SFD71P
- If you operate the air conditioner with dirty filters:-**
 - Air is not purified
 - Cooling capacity decreases
 - Foul odour is emitted

When not using the air conditioner for a long period

1 Operate the air conditioner for 2 to 3 hours.

- Type of operation: Fan.

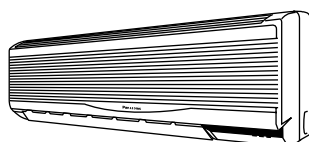

In order to dry out the internal mechanisms

2 For air conditioners with a power plug, stop operation by remote control and pull out the power plug.

Note: If the unit is not off by remote control, the unit will operate when you plug in (because of Auto-restart Control is provided).

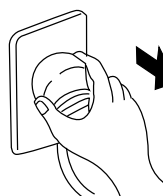

3 Remove the batteries from the remote control.

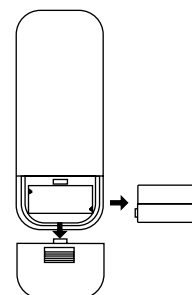

Pre-season inspection (The earlier the better)

■ Operate for 15 minutes.

If the difference in temperature between the air outlet vent and air intake vent is 8°C or more when cooling, the unit is normal.



■ Are the air outlet vents and air intake vents obstructed?



■ Is the drain hose cracked or crushed?

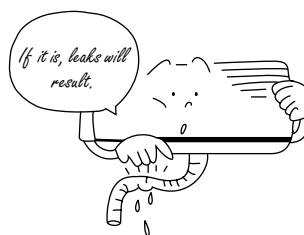

■ Are the remote control batteries in good condition?

If display is faint or no display is visible, the batteries should be replaced.



Troubleshooting

Normal operation

Q Is it okay?

A This is the answer.

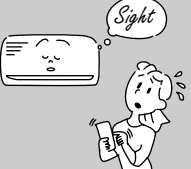

Air conditioner has been restarted, but does not operate for 3 minutes.

This is to protect the air conditioner. Wait until the air conditioner begins operating.



During Soft Dry Mode Operation, the air conditioner stops.

Soft Dry Mode Operation is a very gentle Cooling Operation consisting primarily of dehumidifying. The air conditioner may stop for approximately 6 minutes in order to prevent overcooling. If the room temperature rises again, the operation will recommence.



The room has a peculiar odour.

This may be a damp smell exuded by the walls, carpet, furniture or clothing in the room.



A sound like water flowing can be heard.

This is the sound of refrigerant flowing inside the air conditioner unit.



It seems that fog is coming out from the air conditioner.

Condensation occurs when the airflow from the air conditioner cools the room air.



During Automatic Airflow Volume setting, indoor fan stops occasionally.

This is to remove the smell exuded by the surroundings.

Abnormal operation

The air conditioner does not operate.

- Has the circuit breaker been tripped?
- Has the power plug been removed from the wall outlet?
- Is the Timer being used correctly?
- Has the **REMOTE CONTROLLER B ↔ A** switch been set to "B"?

The air conditioner does not cool effectively.

- Has the temperature been set incorrectly?
- Are the filters dirty?
- Are the intake or outlet vents of the outdoor unit obstructed?
- Are all windows and doors closed?

Air conditioner operation noise too loud.

- Is the installation work slanted?
- Is the front grille closed properly?

Call the dealer immediately

If the following conditions occur, immediately turn the power plug or turn off the power breaker.

■ **Abnormal noise is heard during operation.**

■ **Switches or buttons do not operate properly.**

■ **Water or foreign material gets into the remote control by mistake.**

■ **The circuit breaker switches off frequently.**

■ **Water leaks from the indoor unit.**

■ **Power supply cord and plug become unusually warm.**



WARNING

- (1) REMOVE POWER PLUG OR DISCONNECT FROM THE MAINS BEFORE SERVICING THIS APPLIANCE.
- (2) THIS APPLIANCE MUST BE EARTHED.
- (3) THE APPLIANCE IS NOT INTENDED FOR USE BY YOUNG CHILDREN OR INFIRM PERSONS WITHOUT SUPERVISION
- (4) YOUNG CHILDREN SHOULD BE SUPERVISED TO ENSURE THAT THEY DO NOT PLAY WITH THE APPLIANCE.

IMPORTANT

Replacement or installation of power plugs shall be performed only by authorised/qualified personnels.

1. WHEN THE POWER CORD IS CONNECTED TO THE MAINS THROUGH A MULTI POLAR SWITCH

THERE MUST BE A MULTI POLAR SWITCH (DISCONNECTING MEANS) WITH A MINIMUM 3 mm CONTACT GAP IN THE FIXED INSTALLATION CIRCUIT.

2. WHEN THE POWER PLUG IS CONNECTED TO THE RECEPTACLE

The wires in this main lead are coloured in accordance with the following code :

Green-and-yellow : Earth
 Blue : Neutral
 Brown : Live

If the colours of the wires in the main lead of this appliance do not correspond with the coloured markings indentifying the terminals in your plug, proceed as follows :

The green-and-yellow wire must be connected to the terminal in the plug which is marked with letter E or by the earth symbol  or coloured green or green-and-yellow.

The blue wire must be connected to the terminal which is marked with the letter N or coloured black.

The brown wire must be connected to the terminal which is marked with the letter L or coloured red.

Fuse Specifications	Indoor	Outdoor
	T3.15(A), L250(V)	T3.15(A), L250(V)

NOTE

IF THE SUPPLY CORD IS DAMAGED, IT MUST BE REPLACED WITH A SPECIAL CORD OR ASSEMBLY AVAILABLE FROM THE MANUFACTURER OR IT'S SERVICE AGENT.

10 Installation Instructions

10.1. New refrigerant Series [R407C] pipe installation

10.1.1. Procedure

- The new refrigerant (R407C) has a different composition to the previously-used refrigerant (R22), so some contents and method of pipe installation and charging work are different from before. Care should be taken when carrying out this work.

10.1.2. Installation and precautions

10.1.2.1. Before installation

- Determine the installation division.
- Check the refrigerant to be used.
 - Check that the refrigerant is R407C.
 - Check that the gauge pressure is at a maximum of 3.3 MPa.
- Make a drawing of the Installation.

10.1.2.2. Installation

- Install the sleeve and the insert.
- Install the indoor unit.
- Install the refrigerant piping.
 - Pipe materials (**Phosphorous Deoxidization Seamless Pipe**)
 - Refrigerant pipes which were previously used to carry R22 must not be re-used. If replacing the indoor and outdoor units, be sure to replace all refrigerant pipes also.
 - Check the pipe thickness. (1/4,3/8,1/2:t=0.8mm 5/8,3/4:t=1.0mm)
 - Clean the inside of the pipes.
 - When storing pipes, seal both ends of the pipes and store them indoors to prevent water, dust and other foreign particles from getting inside.
 - Take care not to let any foreign particles (oxide scales, water or dirt) get inside the refrigerant lines (same as for R22).

Location	Installation period	Storing method
Outdoors	1 month or more	Pinching
	Less than 1 month	Pinching or taping
Indoors	Any	

- Pinching method

Close off the ends of the pipes with pliers or similar tool and seal the opening by brazing.

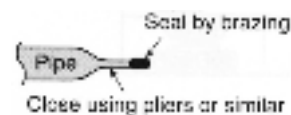

- Taping method

Wind PVC tape around the ends of the pipes to seal the openings.

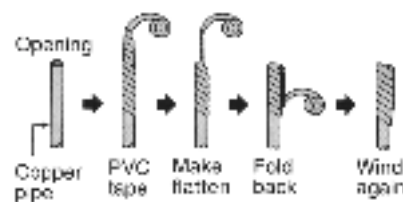

- Do not work for refrigerant piping on outdoor on rainy days.
- Seal by brazing.
- Be sure to use only a non-oxidizing brazing material. (Use nitrogen. Anti-oxidants cannot be used.)

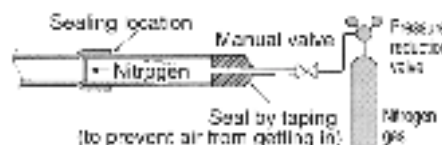

- When brazing pipes together, or when brazing copper pipes and copper joints, use a brazing material (Bcup-3) which does not require flux.
- Flare processing and ester oil.
- Sealing can be improved by applying ester oil or mineral oil (the minimum amount necessary) to flares and flange connections.
- Due to the high hygroscopic tendency for ester oil, do not mix or use any other impurities. (This can cause deterioration of the compressor oil and problems with the compressor.)
- After preparing the refrigerant pipes, close both ends of the pipes by brazing if not immediately connecting them.
- A torque wrench must be used.

- Install the drain pipe.
- Install the ducts.
- Insulate against heat.
- Carry out the electrical work.
 - Connecting cables and power cables.
- Make all necessary settings.
- Prepare the outdoor unit foundation.
- Install the outdoor unit.

11. Air-tightness test.

For the final check, there should be no pressure drop when 3.3 MPa is applied for 24 hours.

12. Vacuum drying.

Vacuum draw time	60 min. or more
------------------	-----------------

* Vacuum pump capacity 60 l/min. or higher

- Drawing the vacuum will remove any moisture.
- The pressure after vacuum drawing should be 755 mmHg or less.
- Use a special vacuum pump (with backflow-prevention mechanism).
- Gas must never be used for air purging.

13. Additional refrigerant charging.

- Check that refrigerant volume is correct.
- Be sure to charge refrigerant in liquid state.
- Always charge in liquid state.

When the refrigerant is charged from the cylinder, the composition may change greatly (compounds which do not easily evaporate may remain inside the cylinder), so the refrigerant must always be charged in a liquid state.

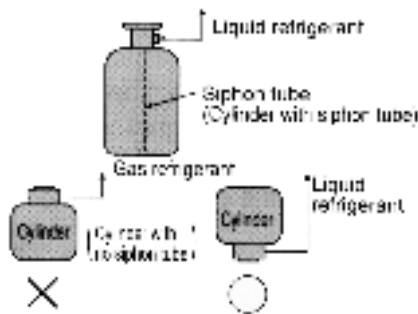

(It is recommended that a manifold with sight glass be used.)

■ Boiling point at normal atmospheric pressure (reference)

Refrigerant	HFC32	HFC125	HFC134a
Boiling point	-52°C	-49°C	-26°C

- Use a special gauge manifold and charging hose.
- If refrigerant leaks occur, replace all of the refrigerant (same as for R22).
- Note that a R22 leak detector cannot be used to detect leaks.
- Refer to the Installation Instructions included for the correct charging amount.
- Make a note of additional refrigerant charging amounts in the record table.

14. Test operation and adjustment.

15. Organize documentation before handover.

16. Handover and explanation of operation.

- Ventilation of closed rooms

R407C is a non-flammable refrigerant with low toxicity, but in the gas state its specific gravity is heavier than that of air, and so if leaks occur in a closed room, suffocation may occur. Toxic gases may also be generated if it comes into direct contact with flames, so adequate ventilation must be provided.

Name	Application	Class	Remarks
Pipe cutter	Cutting refrigerant pipes	○	
Flare tool	Flaring of refrigerant pipes	○	
Refrigerant pipe expander (tube expander)	Expanding pipes during connection	○	■ Clean off any refrigerant oil if the tool has been used with the previous refrigerant.
Torque wrench	Tightening flare nuts	○	
Pipe bender	Bending refrigerant pipes	○	
Compressor oil	Applying to flares	⊗	■ Use care when storing and handling due to high hygroscopicity
Nitrogen gas	Preventing oxidation inside refrigerant pipes when welding pipes	○	
Welder	Brazing refrigerant pipe opening	○	
Gauge manifold	Checking vacuum drawing, refrigerant charging and operating pressure	⊗	■ Check pressure-resistance specifications. ● If used previously with R22 air conditioners, compressor oil from that air conditioner may still be present. ● Use a tool with a sight glass to make liquid refrigerant checking easier.
Charging hose		○	● Backflow-prevention mechanism necessary. Charged as screw-on specifications (indicator required)
Vacuum pump	Drawing vacuum and drying	○	
Charging cylinder	Charging refrigerant	×	● Cannot be used for normal usage method due to change in refrigerant composition.
Electronic scale for refrigerant charging		○	● Pressure-resistance and connection opening specifications must be checked.
Electronic gas leak detector	Checking refrigerant leaks	⊗	■ Previous electronic-type gas leak detectors can not detect.
Refrigerant collector	Collection refrigerant	⊗	■ Special equipment required

⊗: Special tool for R407C use required ○: Same tool can be used for R407C and R22 ×: Cannot be used

* It is recommended that materials and tools to be used only for the R407C substitute refrigerant be specially coloured for identification. (Example: Paint a marking by turning the brown colour of R407C cylinder, or attach identification tape.)

Required tools for Installation Works			
1. Phillips screw driver	5. Spanner	9. Gas leak detector	13. Multimeter
2. Level gauge	6. Pipe cutter	10. Measuring tape	14. Torque wrench 18 N.m (1.8 kgf.m) 65 N.m (6.5 kgf.m)
3. Electric drill, hole core drill (\varnothing 70 mm)	7. Reamer	11. Thermometer	15. Vacuum pump
4. Hexagonal wrench (4 mm)	8. Knife	12. Megameter	16. Gauge manifold

10.2. Safety Precautions

- Read this following “SAFETY PRECAUTIONS” carefully before installation.
- Electrical work must be installed by all licensed electrician. Be sure to use the correct rating of the power plug and main circuit for the model to be installed.
- The caution items stated here must be followed because these important contents are related to safety. The meaning of each indication used is as below.

Incorrect installation due to ignoring of the instruction will cause harm or damage, and the seriousness is classified by the following indication.



 WARNING	This indication shows the possibility of causing death or serious injury.
---	---

 CAUTION	This indication shows the possibility of causing injury or damage to properties only.
--	---

The items to be followed are classified by the symbols:

	Symbol with white background denotes item that is PROHIBITED from doing.
---	--

- Carry out test running to confirm that no abnormality occurs after the installation. Then, explain to user the operation, care and maintenance as stated in instruction. Please remind the customer to keep the operating instructions for future reference.

 WARNING	
1. Engage dealer or specialist for installation. If installation done by the user is defective, it will cause water leakage, electrical shock or fire.	
2. Install according to this installation instruction strictly. If installation is defective, it will cause water leakage, electrical shock or fire.	
3. Use the attached accessories parts and specified parts for installation. Otherwise, it will cause the set to fall, water leakage, fire or electrical shock.	
4. Install at a strong and firm location which is able to withstand the set's weight. If the strength is not enough or installation is not properly done, the set will drop and cause injury.	
5. For electrical work, follow the local national wiring standard, regulation and this installation instruction. An independent circuit and single outlet must be used. If electrical circuit capacity is not enough or defect found in electrical work, it will cause electrical shock or fire.	
6. Use the specified cable (2.5 mm ²) and connect tightly for indoor/outdoor connection. Connect tightly and clamp the cable so that no external force will be acted on the terminal. If connection or fixing is not perfect, it will cause heat-up or fire at the connection.	
7. Wire routing must be properly arranged so that control board cover is fixed properly. If control board cover is not fixed perfectly, it will cause heat-up at connection point of terminal, fire or electrical shock.	
8. When carrying out piping connection, take care not to let air or other substances other than the specified refrigerant go into refrigeration cycle. Otherwise, it will cause lower capacity, abnormal high pressure in the refrigerant cycle, explosion and injury.	
9. Do not damage or use unspecified power supply cord. Otherwise, it will cause fire or electrical shock.	
10. Do not modify the length of the power supply cord or use of the extension cord, and do not share the single outlet with other electrical appliances. Otherwise, it will cause fire or electrical shock.	







CAUTION

1. Grounding is necessary. It may cause electrical shock if grounding is not perfect.
2. Do not install the unit at place where leakage of flammable gas may occur. In case gas leaks and accumulates at surrounding of the unit, it may cause fire. 
3. Carry out drainage piping as mentioned in installation instructions. If drainage is not perfect, water may enter the room and damage the furniture.

ATTENTION

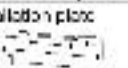
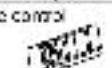
1. Selection of the installation location and installation.
Select a installation location which is rigid and strong enough to support or hold the unit, and select a location for easy maintenance.
2. Power supply connection to the room air conditioner.
Connect the power supply cord of the room air conditioner to the mains using one of the following method.
Power supply point shall be the place where there is ease for access for the power disconnection in case of emergency. In some countries, permanent connection of this room air conditioner to the power supply is prohibited.
 1. Power supply connection to the receptacle using a power plug. And the appliance must be positioned so that the plug is accessible. Use an approved 20A power plug with earth pin for the connection to the receptacle.
 2. Power supply connection to a circuit breaker for the permanent connection. Use an approved 20A circuit breaker for the permanent connection. It must be a double pole switch with a minimum 3 mm contact gap.
3. Do not release refrigerant.
Do not release refrigerant during piping work for installation, re-installation and during repairing a refrigeration parts. Take care of the liquid refrigerant, it may cause frostbite.
4. Installation work.
It may need two people to carry out the installation work.
5. Do not install this appliance in a laundry room or other location where water may drip from the ceiling, etc.

Attached accessories

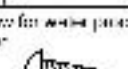
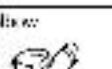
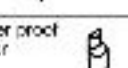
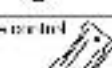
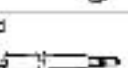
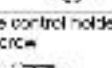
No.	Accessories part	Qty	No.	Accessories part	Qty
1	Installation plate 	1	7	Remote control 	1
2	Installation plate fixing screw 	6	8	Battery 	2
3	Vinyl tape 	3	9	Air purifying filter 	2
4	Screws for water proof cover 	1	10	Drain hose 	1
5	Water proof cover 	1	11	Remote control holder 	1
6	Band 	2	12	Remote control holder fixing screw 	2

Applicable: Flaring piping kit CZ-52F

SELECT THE BEST LOCATION

INDOOR UNIT

- There should not be any heat source or steam near the unit.
- There should not be any obstacles blocking the air circulation.
- A place where air circulation in the room is good.
- A place where air drainage can be easily done.
- A place where noise prevention is taken into consideration.
- Do not install the unit near the door way.
- Ensure the spaces indicated by arrows from the wall, ceiling, or other obstacles.
- Indoor unit of this room air conditioner shall be installed on the wall in a height of at least 2.5 m.

OUTDOOR UNIT

- If an awning is built over the unit to prevent direct sunlight or rain, be careful that heat radiation from the condenser is not obstructed.
- There should not be any animal or plant which could be affected by hot discharged air.
- Keep the spaces indicated by arrows from wall, ceiling, fence or other obstacles.
- Do not place any obstacles which may cause a short circuit of the discharged air.
- If piping length is over 10 m, additional refrigerant should be added as shown in the table.

Piping length and the elevation

Model	Pipe size		Max. Piping Length A (m)	Max. Elevation B (m)	Rated		Additional Refrigerant (g/m)
	Gas	Liquid			Length	Elevation	
V28BKP5	5/8"	1/4"	30	25	7.5	5	40

Example:

If the unit will be installed at a 12 m distance, the quantity of additional refrigerant should be 80 g...(12-10 m) × 40 g/m = 80g

Indoor/Outdoor unit installation diagram

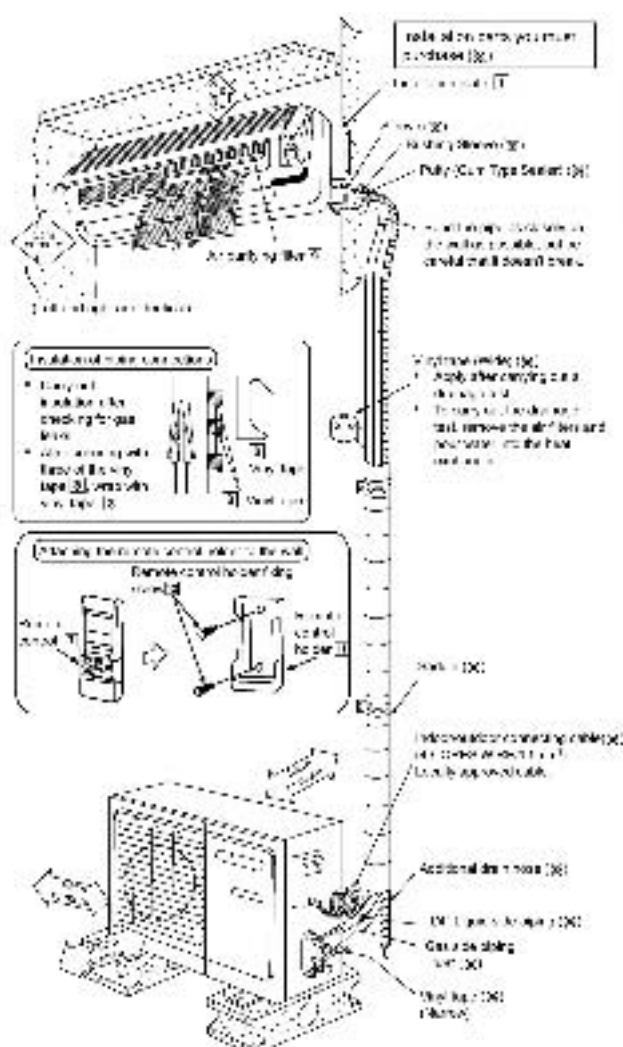
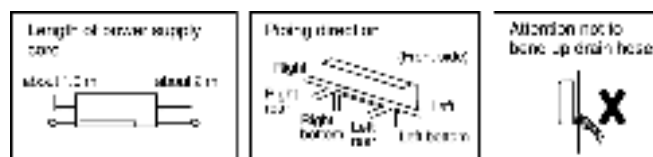

- This illustration is for explanation purposes only. The indoor unit will actually face a different way.

10.3. INDOOR UNIT

10.3.1. SELECT THE BEST LOCATION (Refer to “Select the best location” section)

10.3.2. HOW TO FIX INSTALLATION PLATE

The mounting wall is strong and solid enough to prevent it from the vibration.

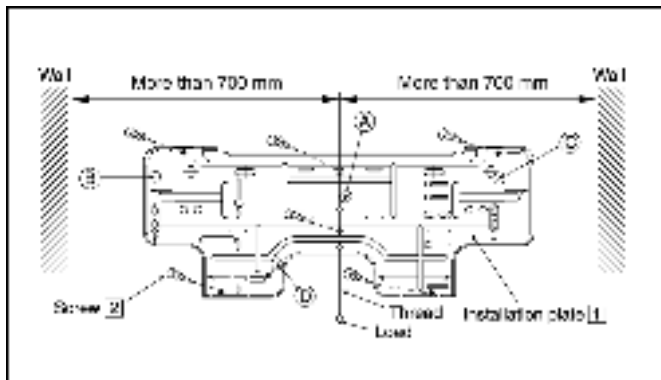

- ⊗ : Unit centre should be at more than 700 mm at right and left of the wall.
The height should be more than 250 mm from the ceiling.
- ⊗ : From installation plate end to unit left side end is 55 mm.
- ⊗ : From installation plate end to unit right side end is 55 mm.
- ⊗ : Indoor outdoor connecting cable should be about 1100 mm from this line. (Only for left rear piping)

1. Mount the installation plate on the wall with 6 screws.
(If mounting the unit on the concrete wall, consider using anchor bolts.)

- Always mount the installation plate horizontally by aligning the marking-off line with the thread and using a level gauge.

2. Drill the piping plate hole with $\phi 70$ mm hole-core drill.

- Line according to the arrows marked on the lower left and right side of the installation plate. The meeting point of the extended line is the centre of the hole.
- Drill the piping hole at either the right or the left and the hole should be slightly slant to the outdoor side.

10.3.3. TO DRILL A HOLE IN THE WALL AND INSTALL A SLEEVE OF PIPING

1. Insert the piping sleeve to the hole.
2. Fix the bushing to the sleeve.
3. Cut the sleeve until it extrudes about 15 mm from the wall.

Caution

When the wall is hollow, please be sure to use the sleeve for tube ass'y to prevent dangers caused by mice biting the indoor/outdoor connecting cable.

4. Finish by sealing the sleeve with putty or caulking compound at the final stage.

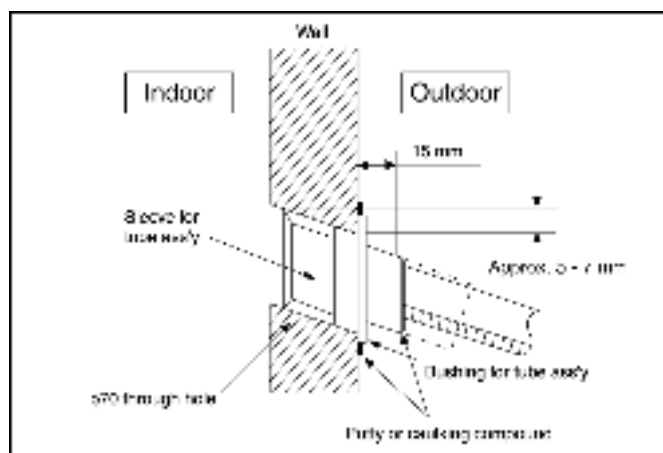

10.3.4. INDOOR UNIT INSTALLATION

1. For the right rear piping

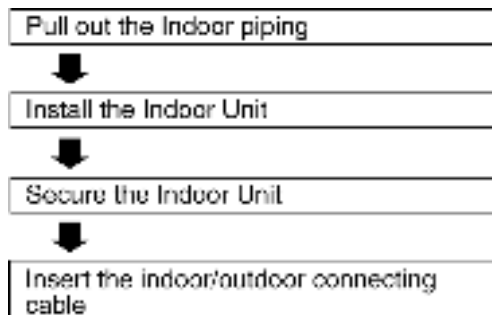

2. For the right and right bottom piping

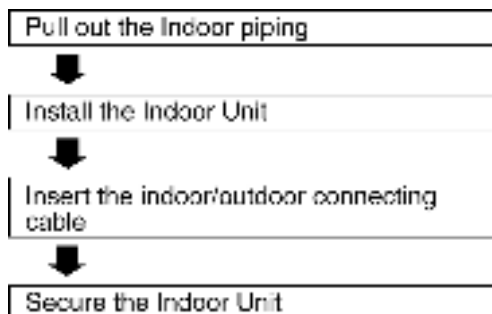

3. For the embedded piping

- Exchange the drain hose and the cap
- ↓
- Bend the embedded piping
- ↓
- Use a spring bender or equivalent to bend the piping so that the piping is not twisted.
- Install the Indoor Unit
- ↓
- Cut and flare the embedded piping
- ↓
- When determining the dimension of the piping, slide the unit all the way to the left on the installation plate. Refer to the section "Cutting and flaring the pipe".
- Pull the indoor/outdoor connecting cable into Indoor Unit
- ↓
- The inside and outside indoor/outdoor connecting cable can be connected without removing the front grille.
- Connect the piping
- ↓
- Please refer to "Connecting the piping" column in outdoor unit section. (Below steps are done after connecting the outdoor piping and gas leakage confirmation.)
- Insulate and finish the piping
- ↓
- Please refer to "Piping and finishing" column of outdoor section and "Insulation of piping connections" column as mentioned in Indoor/Outdoor Unit Installation diagram.
- Secure the Indoor Unit

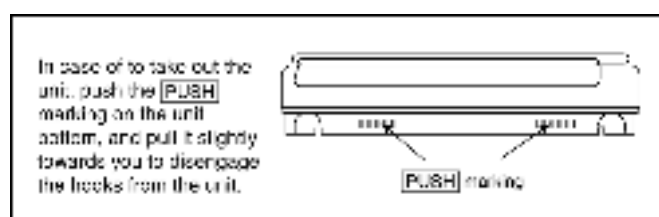
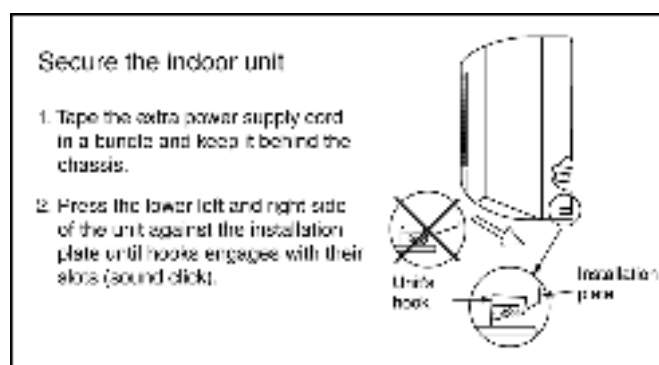
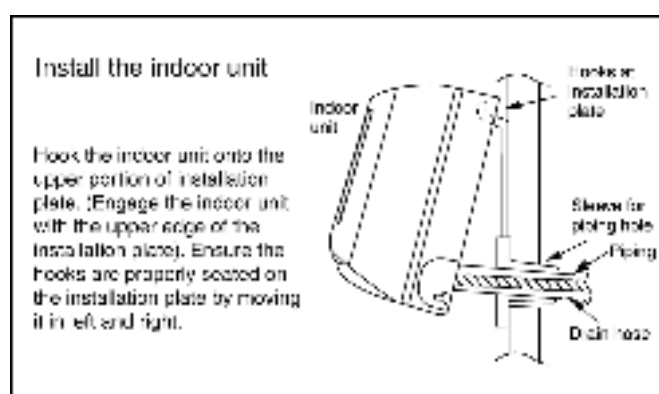

(This can be used for left rear piping and left bottom piping also.)

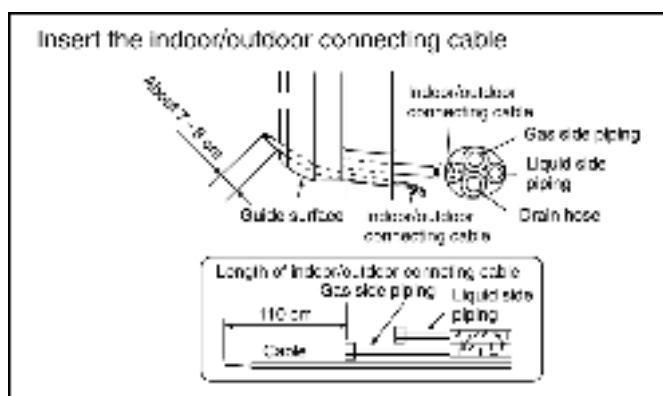
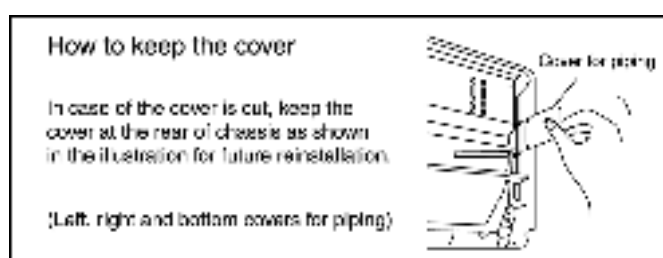
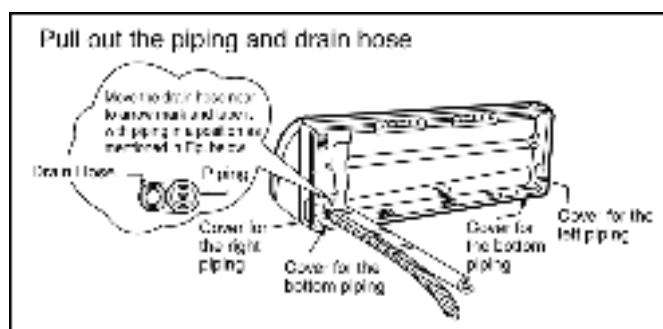
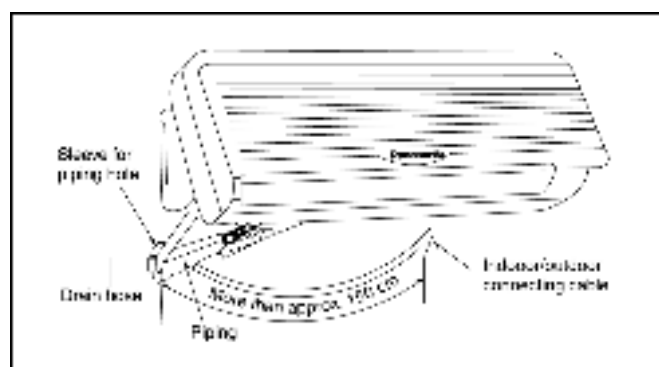
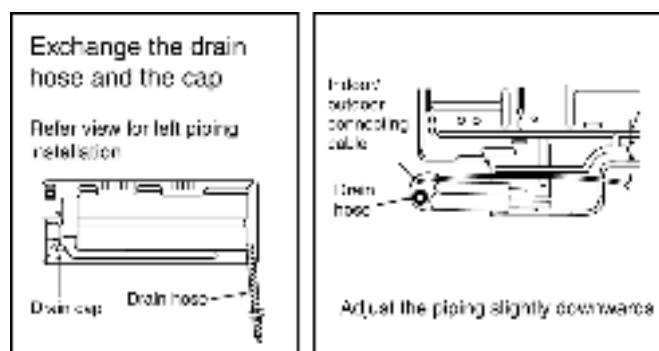

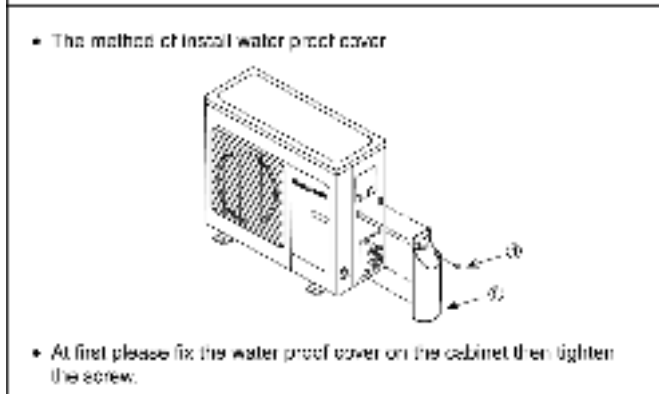
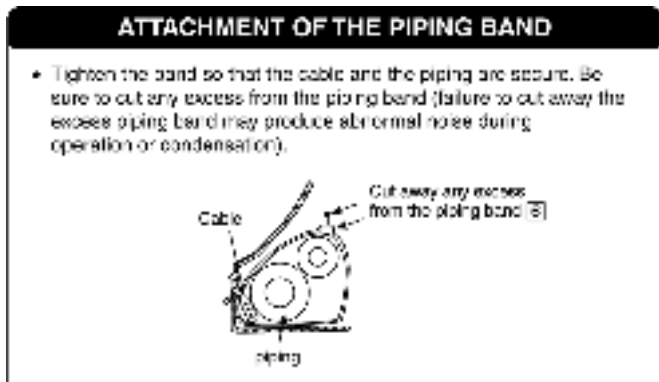
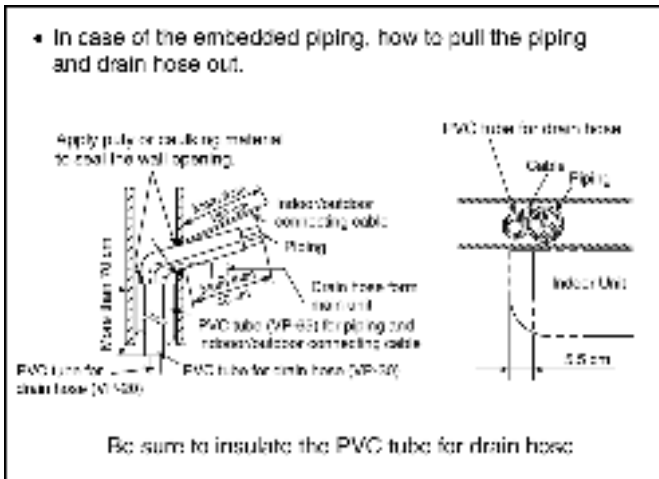
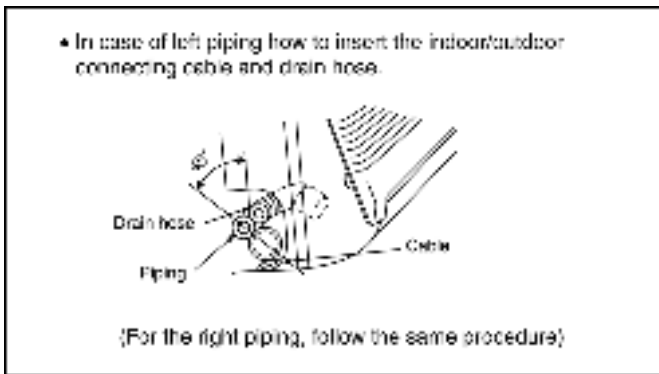

10.3.5. CONNECT THE CABLE TO THE INDOOR UNIT

1. The inside and outside indoor/outdoor connecting cable can be connected without removing the front grille.
2. Indoor/outdoor connecting cable between indoor unit and outdoor unit shall be approved polychlorprene sheathed 3 x 2.5 mm² flexible cord 245 IEC 57 , type designation H05 RN-F or heavier cord.

- Ensure the color of wires of outdoor unit and the terminal Nos. are the same to the indoor's respectively.
- Earth lead wire shall be longer than the other lead wires as shown in the figure for the electrical safety in case of the slipping out of the cord from the anchorage.

Terminals on the indoor unit	1	2
Color of wires		
Terminals on the outdoor unit	1	2



- Secure the cable onto the control board with the holder (clammer).

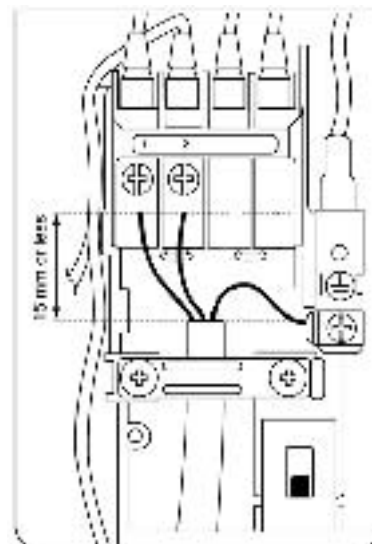

INSTALLATION OF AIR PURIFYING FILTERS

1. Open the front panel.
2. Remove the air filters.
3. Hold the catechin filters by their tabs and install as shown in the illustration at below.

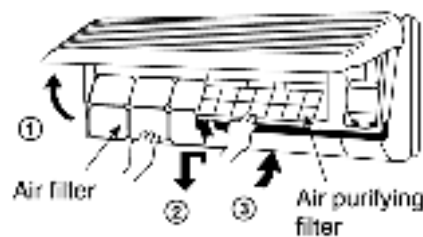

HOW TO TAKE OUT FRONT GRILLE

Please follow below steps to take out front grille if necessary such as when servicing.

Remove the Grille from the chassis.

1. Set the up-and-down air direction louver to open position (horizontally) by finger pressure.



2. Open the three screw covers as shown in the illustration below.

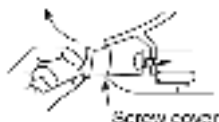

3. Remove the five mounting screws.
4. Open the front panel and remove a mounting screw at the centre.
(Refer Diagram below)
5. To remove the Grille, pull the lower left and right side of the grille towards you (slightly tilted) and lift it straight upwards (Two tabs on the top inside edge of the grille are clear of their slots).

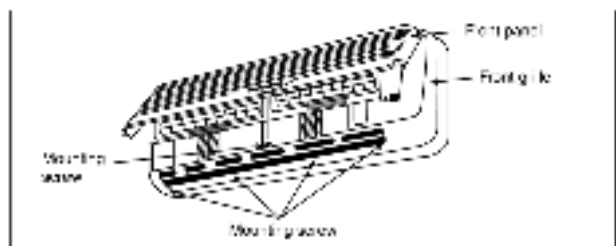

When reinstalling the front grille, first set the vertical airflow direction louver to the horizontal position and then carry out above steps 2-5 in the reverse order.

REMOTE CONTROL NO. SWITCH

1. When installing two air conditioners in one room, each air conditioner can be synchronized to the remote controller.
2. In order to operate separately, open the rear cover of one of the remote controller and set the switch to "B".
3. Also, set the remote control No. switch to "B" in the corresponding indoor unit.

(The switch is located in the control box-sub. of the indoor unit.)



10.4. OUTDOOR UNIT

10.4.1. SELECT THE BEST LOCATION (Refer to "Select the best location" section)

10.4.2. INSTALL THE OUTDOOR UNIT

- After selecting the best location, start installation according to Indoor/Outdoor Unit Installation Diagram.

1. Fix the unit on concrete or rigid frame firmly and horizontally by bolt nut. ($\phi 10$ mm).
2. When installing at roof, please consider strong wind and earthquake. Please fasten the installation stand firmly with bolt or nails.

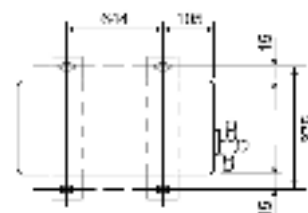

10.4.3. CONNECTING THE PIPING

Connect Piping to Indoor

Please make flare after inserting flare nut (locate at joint portion of tube assembly) onto the copper pipe.

(In case of using long piping)

Connect the piping

- Align the center of piping and sufficiently tighten the flare nut with fingers.
- Further tighten the flare nut with torque wrench in specified torque as stated in the table.



Pipe size	Torque
Liquid Side: 1/2"	15 N·m
Gas Side: 1/2"	15 N·m

Connect the Piping to Outdoor Unit

1. Align the center of the piping and sufficiently tighten the flare nut with fingers.
2. Finally, tighten the flare nut with torque wrench until the wrench clicks.
 - When tightening the flare nut with torque wrench, ensure the direction for tightening follows the arrow on the wrench.

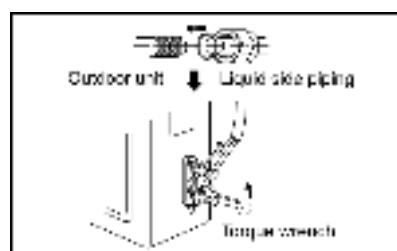

CUTTING AND FLARING THE PIPING

1. Please cut using pipe cutter and then remove the burrs.
2. Remove the burrs by using reamer. If burrs is not removed, gas leakage may be caused.
Turn the piping end down to avoid the metal powder entering the pipe.
3. Please make flare after inserting the flare nut onto the copper pipes.

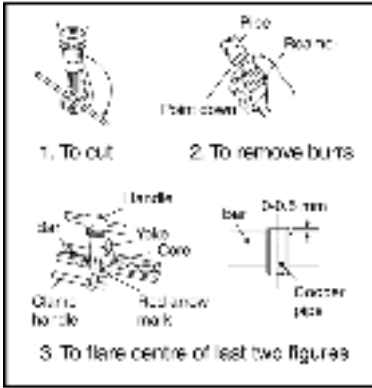

2. Connect the center hose of the charging set to a vacuum pump.
3. Turn on the power switch of the vacuum pump and make sure that the needle in the gauge moves from 0 cmHg (0 MPa) to -76 cmHg (-0.1 MPa). Then evacuate the air approximately ten minutes.
4. Close the valve of both the Low and High sides of the charging set and turn off the vacuum pump. Make sure that the needle in the gauge does not move after approximately five minutes.
Note: BE SURE TO TAKE THIS PROCEDURE IN ORDER TO AVOID REFRIGERANT GAS LEAKAGE.
5. Disconnect the charging hose from the vacuum pump and from the service port of the 3-way valve.
6. Tighten the service port caps of the 3-way valve at torque of 18 N.m with a torque wrench.
7. Remove the valve caps of both the 3-way valve. Position both of the valves to "OPEN" using a hexagonal wrench (4 mm).
8. Mount valve caps both of the 3-way valves.
 - Be sure to check for gas leakage.

10.4.4. EVACUATION OF THE EQUIPMENT

WHEN INSTALLING AN AIR CONDITIONER, BE SURE TO EVACUATE THE AIR INSIDE THE INDOOR UNIT AND PIPES in the following procedure.
If air remains in the indoor unit and refrigeration pipes, it will affect the compressor, reduce to cooling capacity, and could lead to a malfunction.

CAUTION

- If gauge needle does not move from 0 cmHg (0 MPa) to -76 cmHg (-0.1 MPa), in step 3 above take the following measure:
- If the leak stops when the piping connections are tightened further, continue working from step 3.
- If the leak does not stop when the connections are retightened, repair the location of leak.

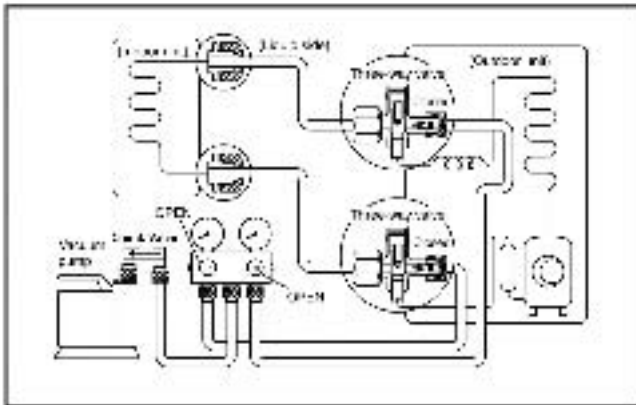

SERVICE PORT CAP
Be sure, using a torque wrench to tighten the service port cap (after using the service port), so that it prevents the gas leakage from the refrigeration cycle.

Procedure:

1. Connect a charging hose with a push pin to the Low and High sides of a charging set and the service port of the 3-way valve.
 - Be sure to connect the end of the charging hose with the push pin to the service port.

10.4.5. CONNECT THE CABLE TO THE OUTDOOR UNIT

(FOR DETAIL REFER TIO WIRING DIAGRAM AT UNIT)

1. Remove the control board cover from the unit by loosening the screw.
2. Indoor/outdoor connecting cable between indoor unit and outdoor unit shall be approved polychlorprene sheathed 3 x 2.5 mm² flexible cord 245 IEC 57 ,type designation H05 RN-F or heavier cord.

Terminals on the indoor unit	1	2
Color of wires	Grey	Black
Terminals on the outdoor unit	1	2



3. Secure the cable onto the control board with the holder (clammer).
4. Attach the control board cover to the original position with the screw.

10.4.6. PIPE INSULATION

1. Please carry out insulation at pipe connection portion as mentioned in Indoor/Outdoor Unit Installation Diagram. Please wrap the insulated piping end to prevent water from going inside the piping.
2. If drain hose or connecting piping is in the room (where dew may form), please increase the insulation by using POLY-E FOAM with thickness 6 mm or above.

CHECK THE DRAINAGE

1. Pour a glass of water into the drain tray-styrofoam.
2. Ensure if water flows out from drain hose of indoor unit.

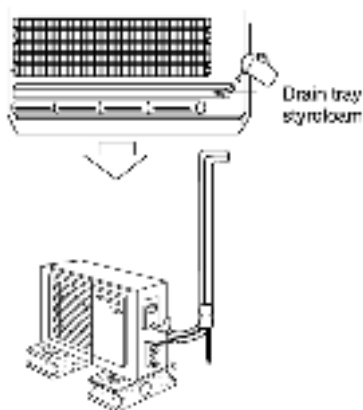

DISPOSAL OF OUTDOOR UNIT DRAIN WATER

- If a drain elbow is used, the unit should be placed on a stand which is taller than 3 cm.

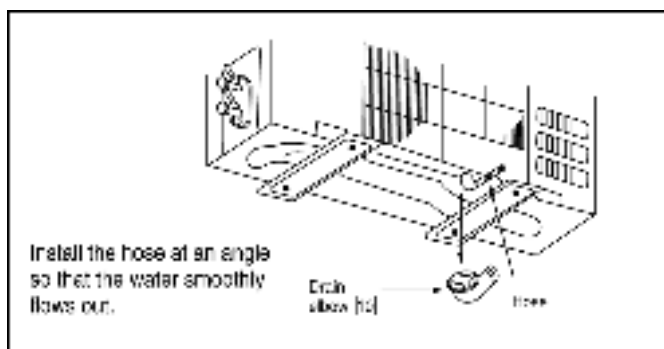

EVALUATION OF THE PERFORMANCE

1. Operate the unit at cooling operation mode for fifteen minutes or more.
2. Measure the temperature of the intake and discharge air.
3. Ensure the difference between the intake temperature and the discharge is more than 8°C.

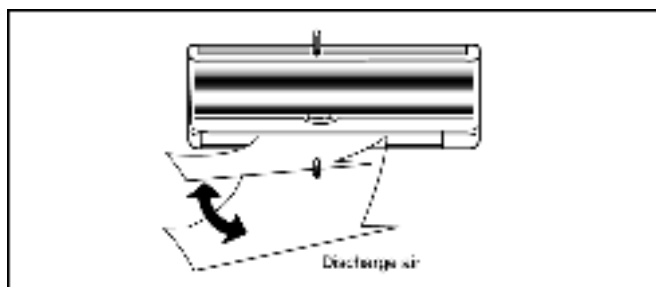

CHECK ITEMS

- Is there any gas leakage at flare nut connections?
- Has the heat insulation been carried out at flare nut connection?
- Is the indoor/outdoor connecting cable being fixed to terminal board firmly?
- Is the indoor/outdoor connecting cable being clamped firmly?
- Is the drainage OK?
(Refer to "Check the drainage" section)
- Is the earth wire connection properly done?
- Is the indoor unit properly hooked to the installation plate?
- Is the power supply voltage complied with rated value?
- Is there any abnormal sound?
- Is the cooling operation normal?
- Is the thermostat operation normal?
- Is the remote control's LCD operation normal?
- Is the air purifying filter installed?

11 3-way Valve

	3-way Valve (Liquid Side)		3-way Valve (Gas Side)	
Works	Shaft Position	Service Port	Shaft Position	Service Port
Shipping	Close (With valve cap)	Closed (With cap)	Closed (With valve cap)	Closed (With cap)
Evacuation (Installation and Re-installation)	Closed (Clockwise)	Open (Connected manifold gauge w/charging cylinder)	Closed (Clockwise)	Open (Push-pin)
Operation	Open (With valve cap)	Closed (With cap)	Open (With valve cap)	Closed (With cap)
Pumping down (Transferring)	Closed (Clockwise)	Closed (With cap)	Open (Counter-Clockwise)	Open (Connected manifold gauge)
Evacuation (Servicing)	Open (Counter-Clockwise)	Open (Connected manifold gauge)	Open (Counter-Clockwise)	Open (Connected manifold gauge)
Gas charging (Servicing)	Open (Counter-Clockwise)	Open (Connected manifold gauge)	Open (Counter-Clockwise)	Open (Connected manifold gauge)
Pressure check (Servicing)	Open (Counter-Clockwise)	Open (Connected manifold gauge)	Open (Counter-Clockwise)	Open (Connected manifold gauge)
Gas releasing (Servicing)	Open (Counter-Clockwise)	Open (Connected manifold gauge)	Open (Counter-Clockwise)	Open (Connected manifold gauge)

11.1. Evacuation of Installation

When installing an air conditioner, be sure to evacuate the air inside the indoor unit and pipes in the following procedure.

Required tools: hexagonal wrench, adjustable wrench, torque wrenches, wrench to hold the joints, gas leak detector, and charging set.

The air in the indoor unit and in the piping must be purged. If air remains in the refrigeration pipings, it will affect the compressor, reduce the cooling capacity, and could lead to a malfunction.

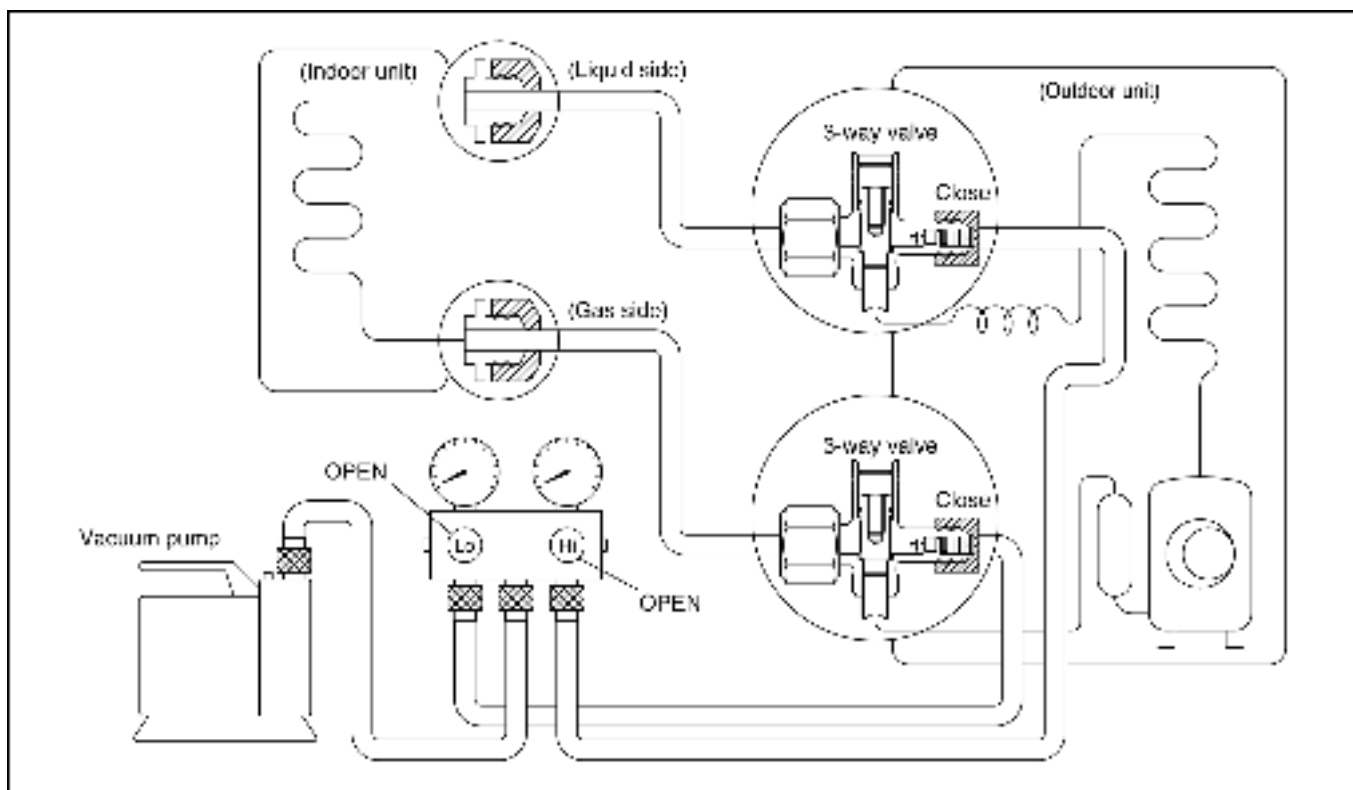

Service port cap

Be sure, using a torque wrench to tighten the service port cap (after using the service port), so that it prevents the gas leakage from the refrigeration cycle

Procedure:

1. Connect a charging hose with a push pin to the Low and High sides of a charging set and the service ports of a 3-way valve.
 - Be sure to connect the end of the charging hose with the push pin to the service port.
2. Connect the centre hose of the charging set to a vacuum pump.
3. Turn on the power switch of the vacuum pump and make sure that the needle in the gauge moves from 0 cmHg (0 MPa) to -76 cmHg (-0.1 MPa). Then evacuate the air for approximately 10 minutes.
4. Close the valve of both the Low and High sides of the charging set and turn off the vacuum pump. Make sure that the needle in the gauge does not move after approximately 5 minutes.

BE SURE TO TAKE THIS PROCEDURE IN ORDER TO AVOID REFRIGERANT GAS LEAKAGE.
5. Disconnect the charging hose from the vacuum pump and from the service port of the 3-way valve.
6. Tighten the service port caps of both the 3-way valves at a torque of 18 N.m with a torque wrench.
7. Remove the valve caps of the 3-way valves. Position both of the valves to "open" using a hexagonal wrench (4 mm).
8. Mount the valve caps onto both of the 3-way valves.
 - Be sure to check for gas leakage.

Caution

If gauge needle does not move from 0 cmHg (0 MPa) to -76 cmHg (-0.1 MPa) in step (3) above, take the following measures:

If the leaks stop when the piping connections are tightened further, continue working from step (3).

If the leaks do not stop when the connections are retightened, repair the location of the leak.

11.2. Pumping down

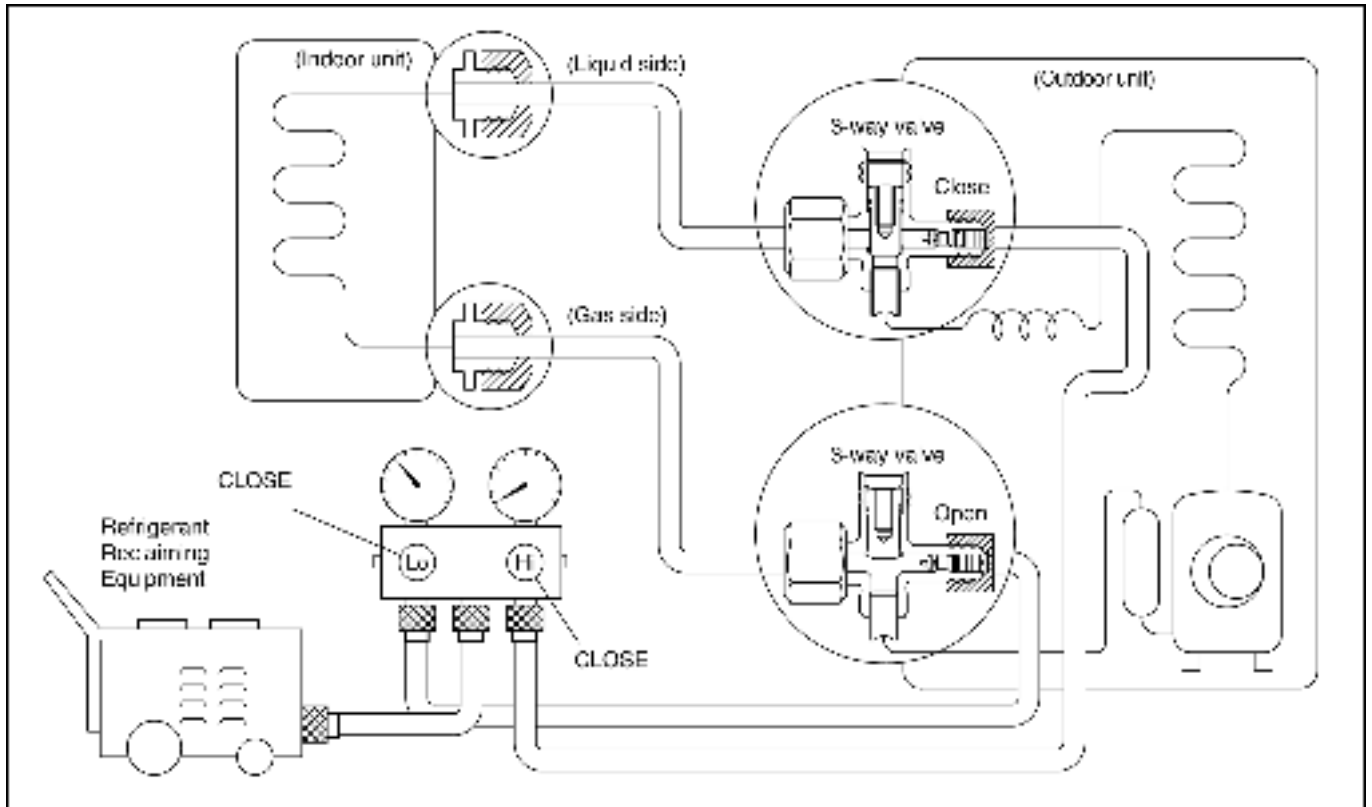

Procedure:

1. **Confirm that both the 3-way valves are set to the open position.**
 - Remove the valve stem caps and confirm that the valve stems are in the open position.
 - Be sure to use a hexagonal wrench to operate the valve stems.
2. **Operate the unit for 10 to 15 minutes.**
3. **Stop operation and wait for 3 minutes, then connect the charge set to the service port of the 3-way valve.**
 - Connect the charge hose with the push pin to the Gas side service port.
4. **Air purging of the charge hose.**
 - Open the low-pressure valve on the charge set slightly to purge air from the charge hose.
5. **Set the Liquid side 3-way valve to the close position.**
6. **Operate the air conditioner at the cooling cycle and stop it when the gauge indicates 0 kg/cm²G (0 MPa).**
 - If the unit cannot be operated at the cool condition (weather is rather cool), press the Pump Down Switch on the Indoor unit.
 - So that the unit can be operated.
7. **Immediately set the gas side 3-way valve to the close position.**
 - Do this quickly so that the gauge ends up indicating 1 to 3 kg/cm²G (0.1 MPa to 0.3 MPa).
8. **Use refrigerant reclaiming equipment to collect refrigerant from indoor unit and pipes.**
9. **Disconnect the charge set, and mount both the 3-way valve's stem nuts and the service port caps.**
 - Use a torque wrench to tighten the service port cap to a torque of 18 N.m.
 - Be sure to check for gas leakage.
10. **Disconnect pipes from indoor unit and outdoor unit.**

11.3. Evacuation of Re-installation

WHEN REINSTALLING AN AIR CONDITIONER, BE SURE TO EVACUATE THE AIR INSIDE THE INDOOR UNIT AND PIPES in the following procedure.

If air remain in the indoor unit and refrigeration pipes, it will affect the compressor, reduce to cooling capacity, and could lead to a malfunction.

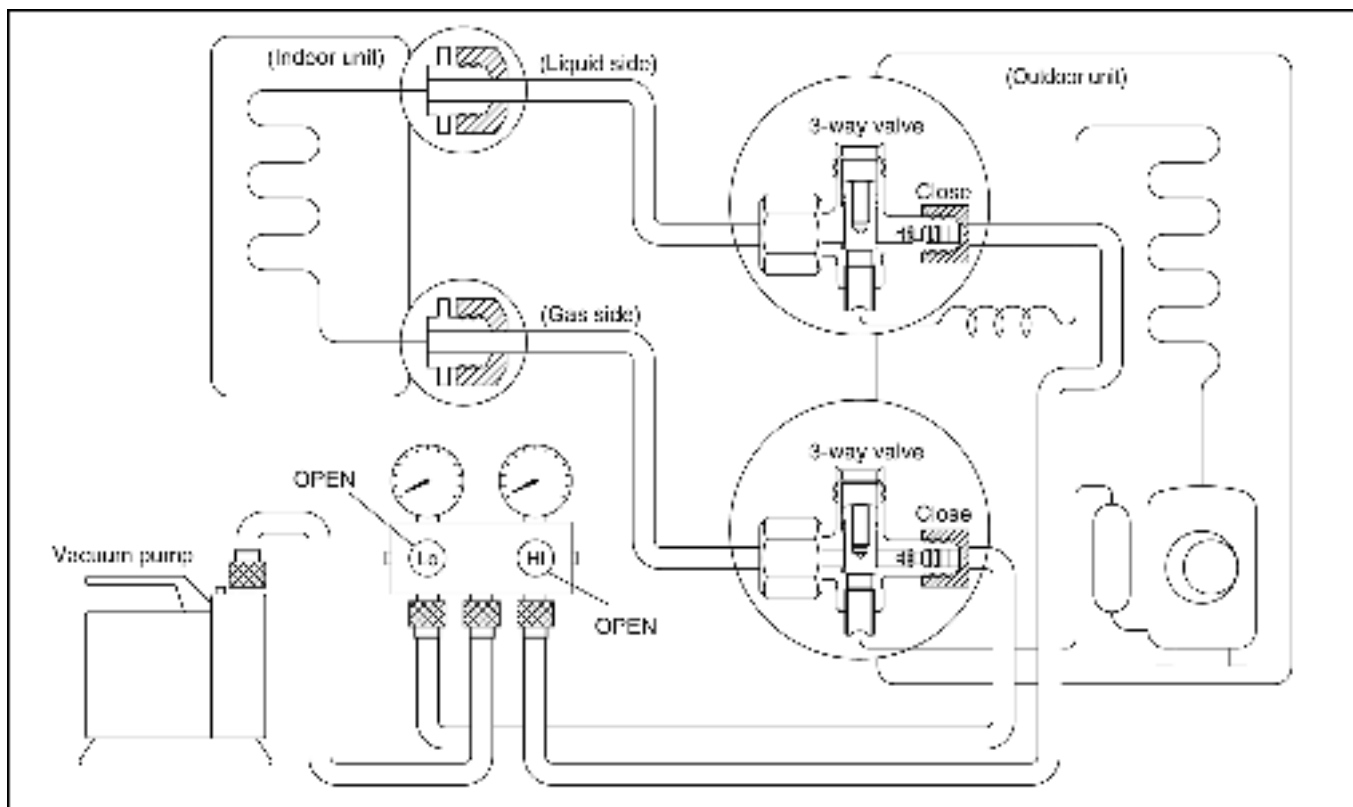

Procedure:

1. Connect a charging hose with a push pin to the Low and High sides of a charging set and the service port of the 3-way valve.
 - Be sure to connect the end of the charging hose with the push pin to the service port.
2. Connect the centre hose of the charging set to a vacuum pump.
3. Turn on the power switch of the vacuum pump and make sure that the needle in the gauge moves from 0 cmHg (0 MPa) to -76 cmHg (-0.1 MPa). Then evacuate the air for approximately 10 minutes.
4. Close the valve of both Low side and High side of the charging set and turn off the vacuum pump. Make sure that the needle in the gauge does not move after approximately 5 minutes.

BE SURE TO TAKE THIS PROCEDURE IN ORDER TO AVOID REFRIGERANT GAS LEAKAGE.
5. Disconnect the charging hose from the vacuum pump.
6. Charge the pipes and indoor unit with gas refrigerant from liquid (High) side 3-way valve service port and then discharge the refrigerant until gas (Low) side gauge needle indicates 3 kg/cm² (0.3 MPa).

• **BE SURE TO USE REFRIGERANT RECLAIMING EQUIPMENT WHILE DISCHARGING THE REFRIGERANT.**

- Purge the air from charge set's centre hose.
- Be sure to check for gas leakage.

Caution

If gauge needle does not move from 0 cmHg (0 MPa) to -76 cmHg (0.1 MPa) in step (3) above, take the following measures:

If the leaks stop when the piping connections are tightened further, continue working from step 3.

If the leaks do not stop when the connections are retightened, repair the location of the leak.

7. Tighten the service port caps of both the 3-way valves at a torque of 18 N.m with a torque wrench.
8. Remove the valve caps of both the 3-way valves. Position both of the valves to "open" using a hexagonal wrench (4 mm).
9. Mount the valve caps onto the 3-way valves.

11.4. Balance refrigerant of the 3-way valves

(Lack of refrigerant in the refrigeration cycle)

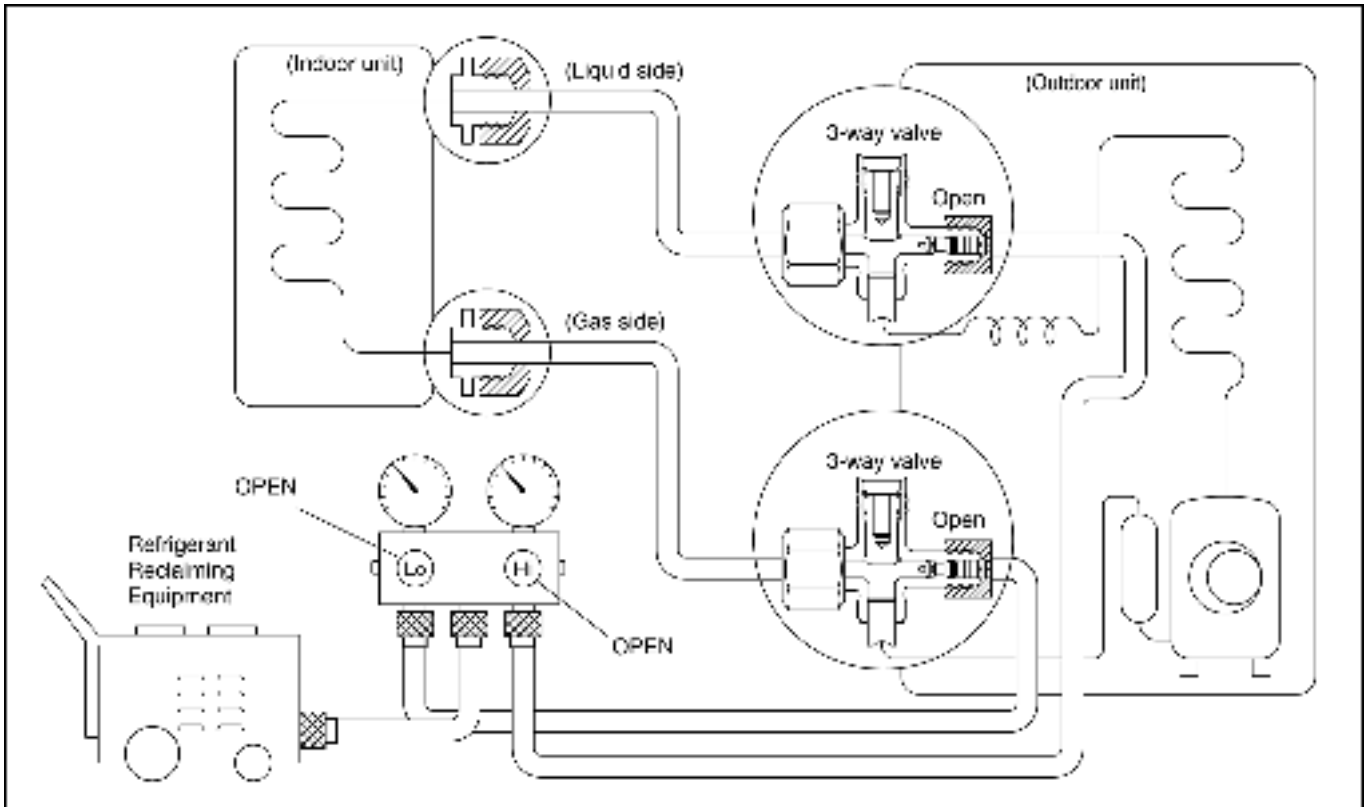

Procedure:

1. Confirm that both the 3-way valves are set to the open position.
2. Connect the charge set to the 3-way valve's service port.
 - Leave the valve on the charge set closed.
 - Connect the charge hose with the push-pin to the service port.
 - Confirm whether the pressure indicates more than 0.1 MPa (1 kg/cm²G).
3. Connect the charge set's centre hose to refrigerant reclaiming equipment.
4. Open the valve (Low side) on the charge set and loosen the hose connected with the Refrigerant Reclaiming Equipment to purge the air from the hose.
5. Turn on refrigerant reclaiming equipment to collect the refrigerant until the needle indicates 0 (no refrigerant is remaining).

11.5. Evacuation

(No refrigerant in the refrigeration cycle)

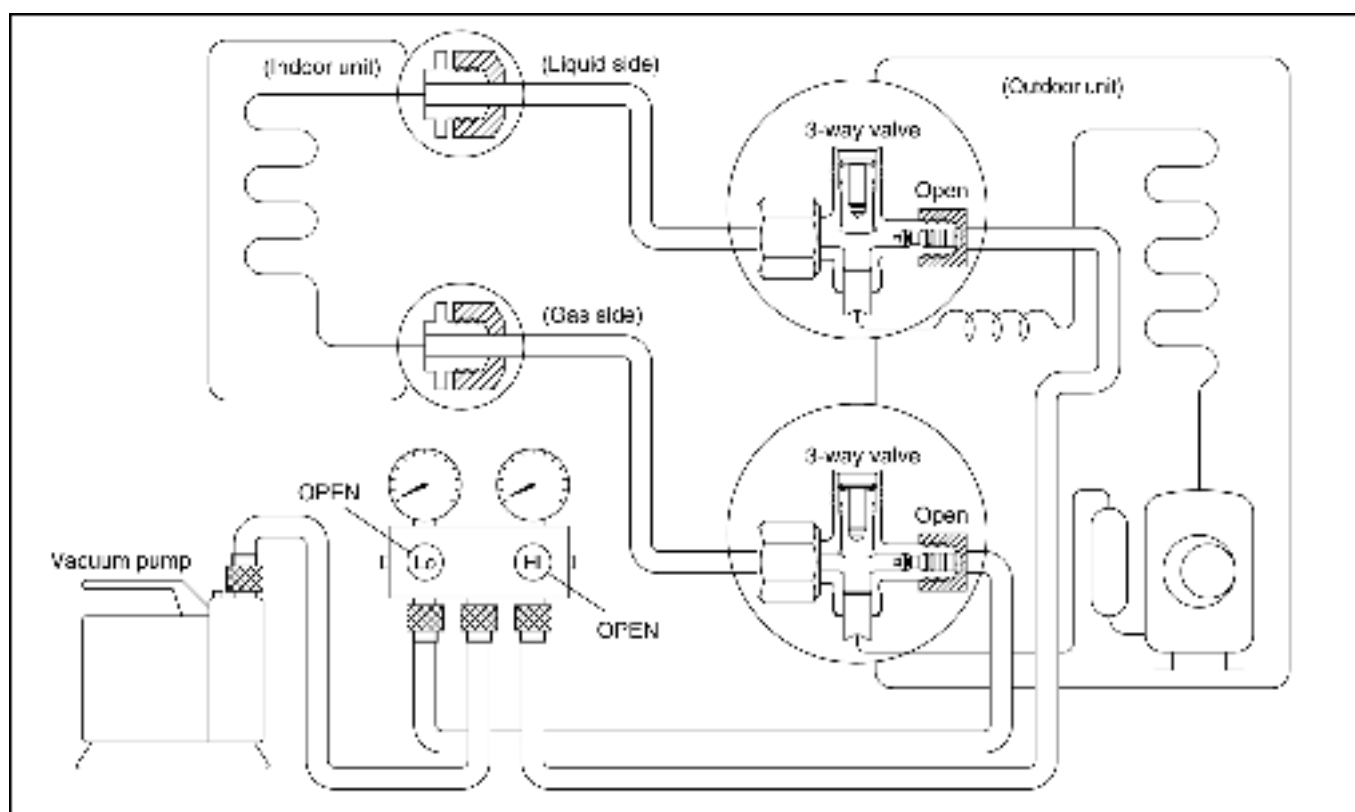

Procedure:

1. Connect the vacuum pump to the charge set's centre hose.
2. Turn on the vacuum pump to evacuate the unit.
 - Confirm that the gauge needle has moved toward -76 cmHg (-0.1 MPa).
 - Apply the vacuum for approximately 1 hour (vacuum of 4 mmHg or less).
3. Close the valve (Low side and High side) on the charge set, turn off the vacuum pump, and confirm that the gauge needle does not move (approximately 5 minutes after the vacuum pump is turned off).
4. Disconnect the charge hose from the vacuum pump.

11.6. Gas charging

(After Evacuation)

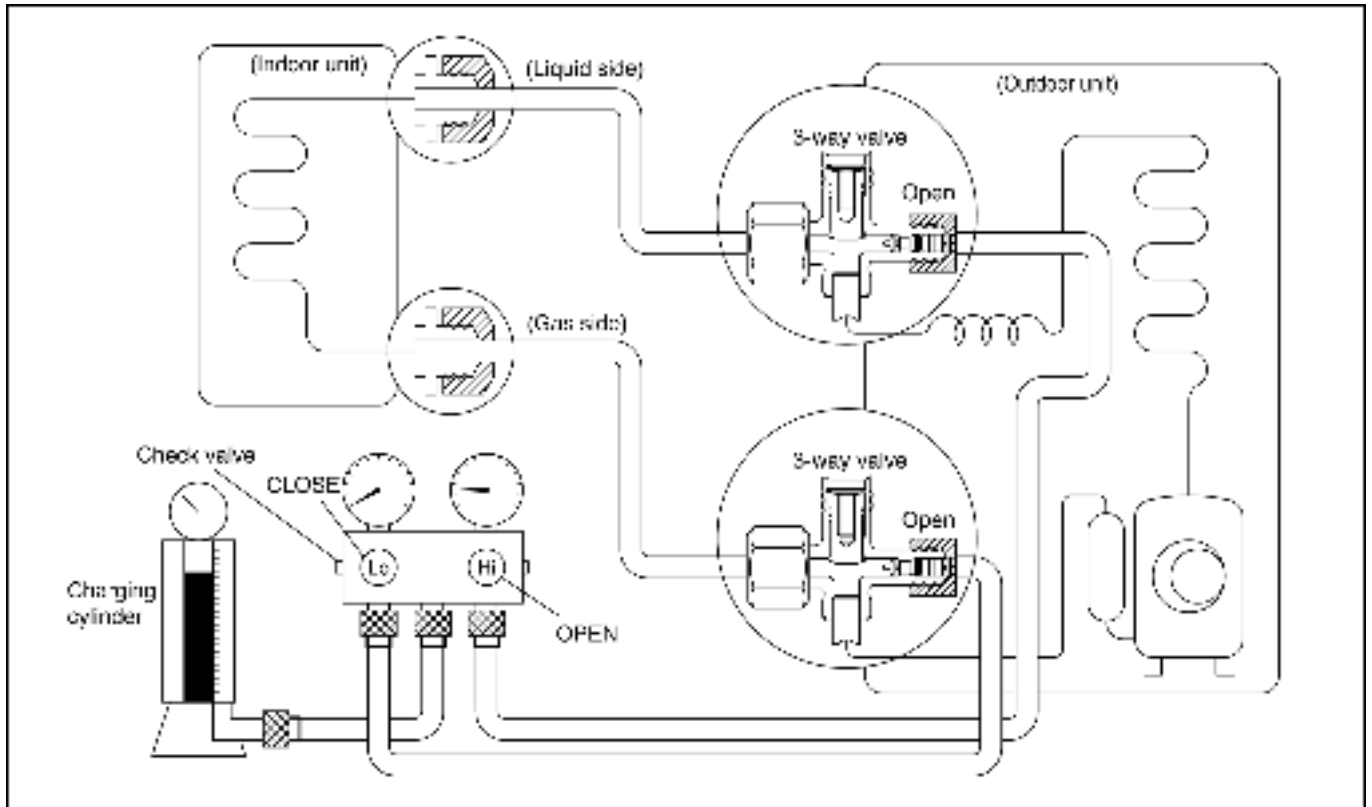

Procedure:

1. Connect the charge hose to the charging cylinder.

- Connect the charge hose which was disconnected from the vacuum pump to the valve at the bottom of the cylinder.

2. Purge the air from the charge hose.

- Open the valve at the bottom of the cylinder and use a screwdriver to press the check valve on the charge set to purge the air (be careful of the liquid refrigerant).

3. Open the High side on the charge set and charge the refrigerant to the unit.

- Be sure to open only the High side valve on the charge set to charge the system from the liquid-side (high-pressure) pipe. (If the system cannot be charged with the specified amount of refrigerant, operate the compressor until the specified amount can be charged, and then close the valve at the bottom of the charge cylinder.)

4. Immediately disconnect the charge hose from both the 3-way valve service ports.

5. Mount the valve stem nuts and the service port caps onto the 3-way valves.

- Use torque wrench to tighten the service port caps to a torque of 18 N.m.
- Be sure to check for gas leakage.

12 Servicing Information

(A) Disassembly of the parts (Indoor Unit)

• Inspection points for the Indoor Electronic Controller

1. The Electronic Controller, a signal Receiver and an Indicator can be seen by removing the Front Grille and Control Board Cover, as shown in the .

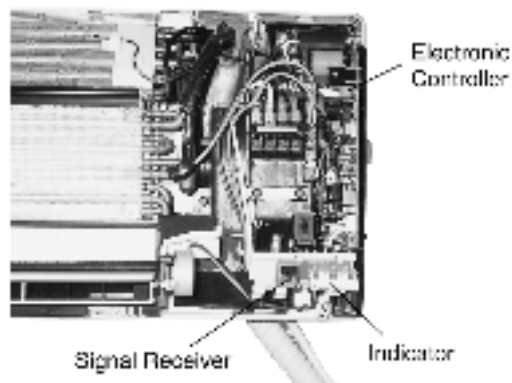

Fig. 1

• Indoor Fan Motor removal procedure:-

1. Remove the connector CN-C of Fan Motor and connector CN-STM of stepping motor from the electronic controller. Release the earth wire (YELLOW-GREEN) from the control board terminal and sensors from its holders. (Refer .)

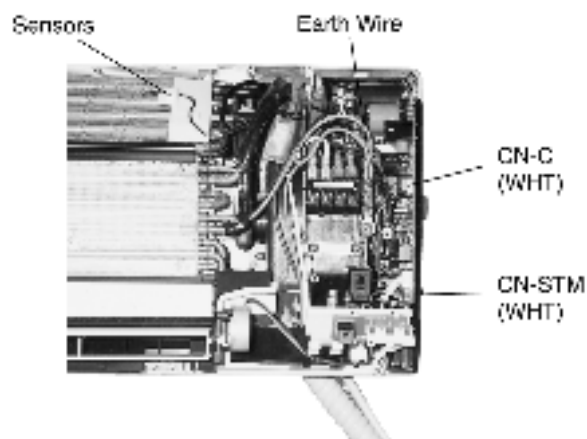

Fig. 2

2. Remove the Control Board.

As shown in remove the 5 screws. Pull the control board forward slightly.

Caution:

Remove of Discharge Grille before removing the control board is necessary to avoid damaging other parts.

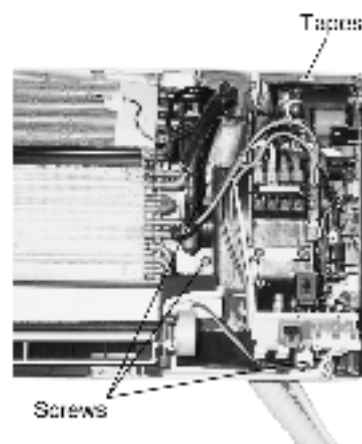

Fig. 3

3. Remove the Discharge Grille.

Remove the Discharge Grille and then pull the Discharge Grille in a down and forward direction.

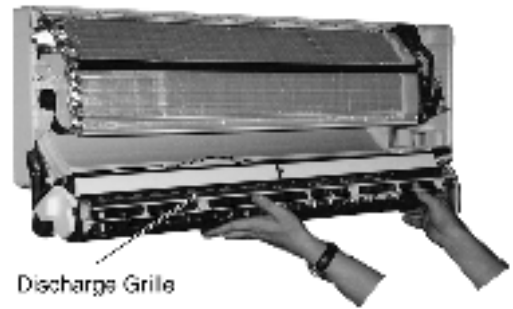

Fig. 4

4. Remove the Indoor Fan Motor.

Loosen the Fan Mounting Screw at the junction with Cross Flow Fan.

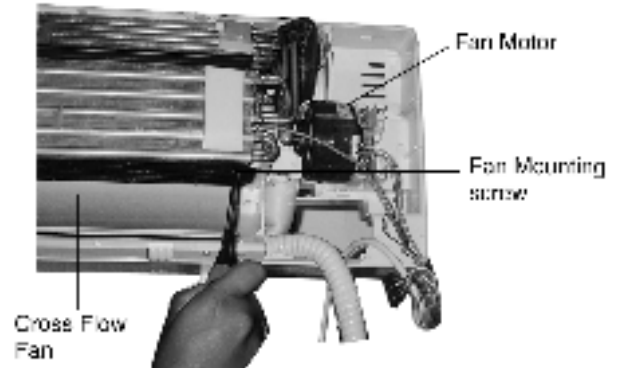

Fig. 5

Loosen the screw at the left side of the evaporator.

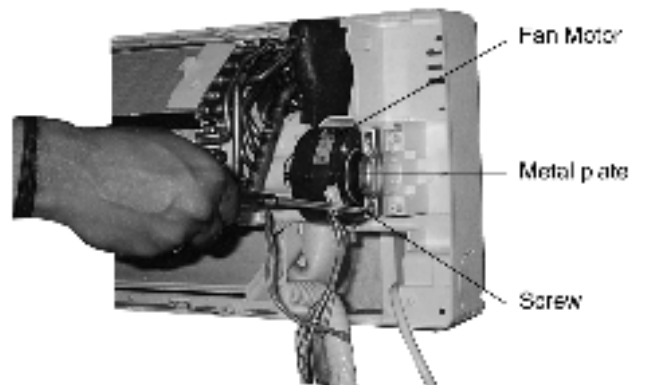

Fig. 6

Pull off the Bearing at the left of the Cross Flow Fan.

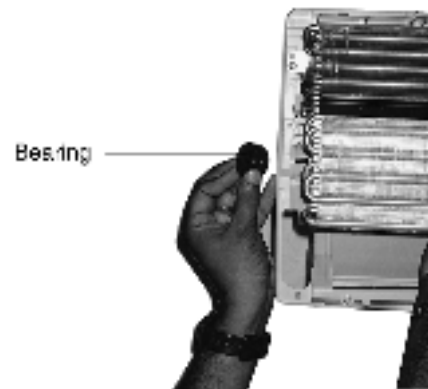

Fig. 7

• **Cross Flow Fan Removal Procedure.**

1. (Refer to No. 4 of Indoor Fan Motor the removal procedure)

Loosen the screw at the right side of the evaporator.



Fig. 8

2. Pull the left side of the evaporator forward slightly and remove the cross Flow Fan.

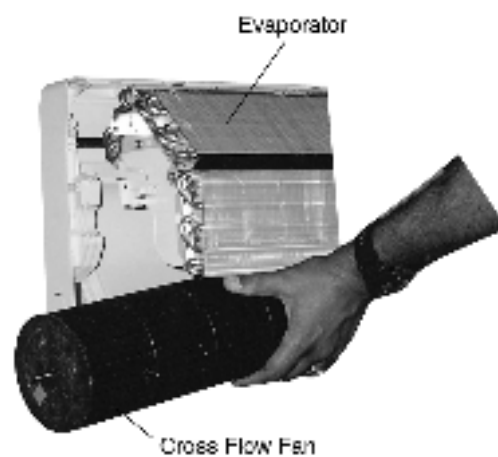

Fig. 9

(B) Disassembly of the parts (Outdoor Unit)

• **Inspection points for the Outdoor Electronic Controller**

1. The Electronic Controller, Can be seen by removing the cabinet Top plate and Front plate, as shown in the .

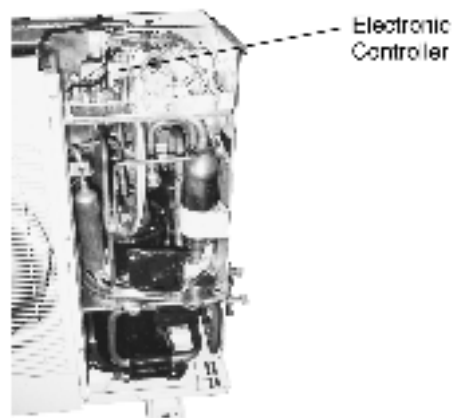

Fig. 10

(C) Remote Control Transmission Setting

• Remote Control Reset

When the batteries are inserted for the first time, or the batteries are replaced, all the indications will blink and the remote control might not work.

If this happen, remove the back cover of the remote control and you will find a resetting terminal, and by shorting it with a minus screwdriver, it will return to normal.

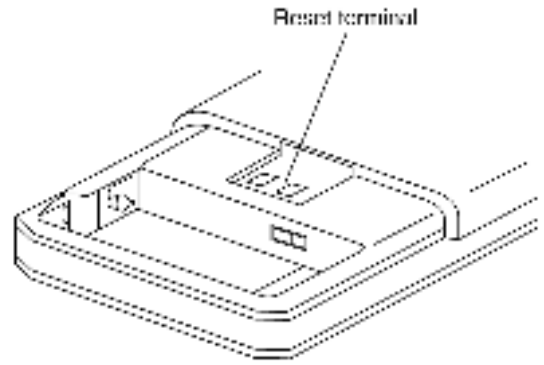

• Changing the wireless remote control transmission code

When two indoor units are installed in the same room, in order to prevent operating errors caused by using two remote controls, set up the remote control [B ↔ A] switch (SW1).

The unit is set to A when it is shipped.

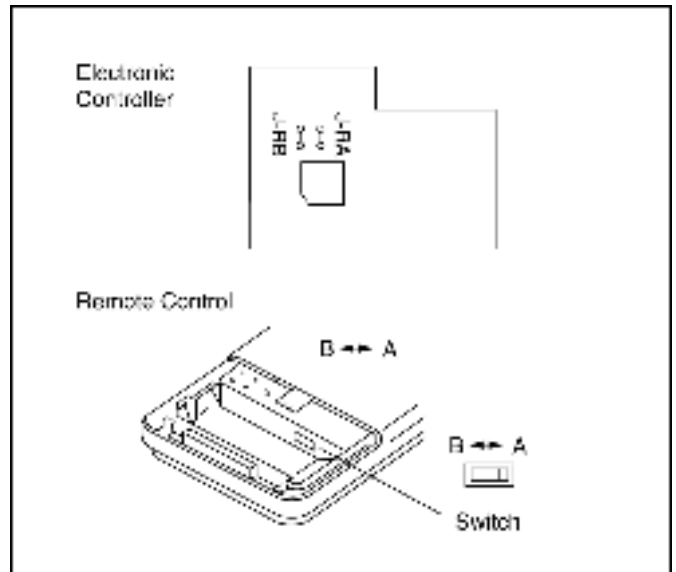

• By adding a jumper wire to the remote control side and CUTTING J-RA, J-RB to the indoor printed circuit board, it is possible to select from 4 types of transmission codes including one at time of delivery condition (1).

	Remote Control		Indoor printed circuit board		Note
	Switch SW B ↔ A	J - B	J - RA	J - RB	
1	A	—	SHORT	SHORT	At product delivery
2	B	—	SHORT	OPEN	
3	A	Jumper wire	OPEN	SHORT	
4	B	Jumper wire	OPEN	OPEN	

13 Troubleshooting Guide

13.1. Refrigeration cycle system

In order to diagnose malfunctions, make sure that there are no electrical problems before inspecting the refrigeration cycle. Such problems include insufficient insulation, problem with the power source, malfunction of a compressor and a fan.

The normal outlet air temperature and pressure of the refrigeration cycle depends on various conditions, the standard values for them are shown in the table to the right.

Normal Pressure and Outlet Air Temperature (Standard)

	Gas pressure MPa (kg/cm ²)	Outlet air temperature (°C)
Cooling Mode	0.1 - 0.6 (1 - 6)	12 - 16
Heating Mode	1.5 - 2.1 (15 - 21)	36 - 45

★ Condition: Indoor fan speed; High
Outdoor temperature 35°C at the cooling mode
and 7°C at the heating mode

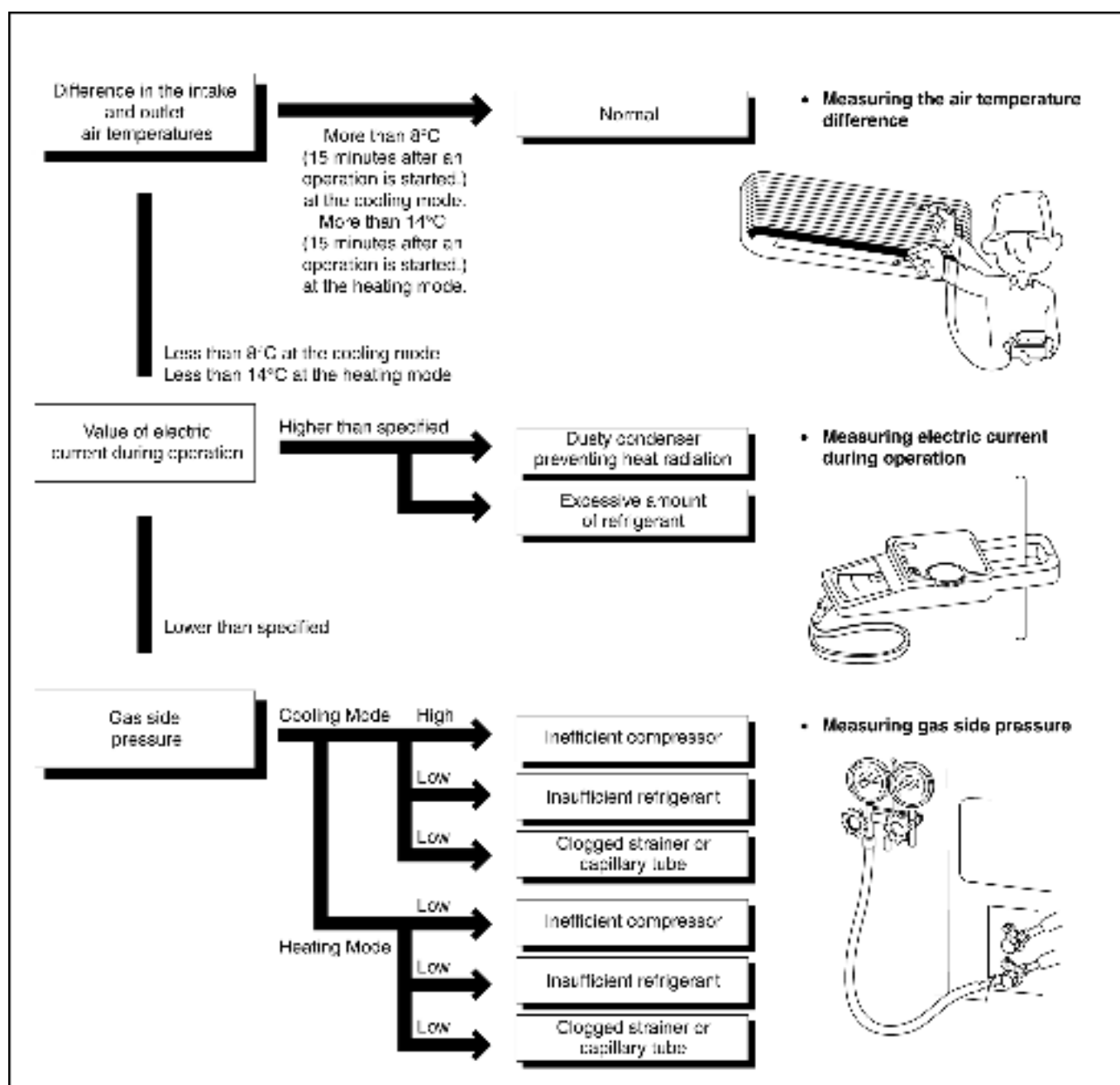

13.1.1. Relationship between the condition of the air conditioner and pressure and electric current

Condition of the air conditioner	Cooling Mode			Heating Mode		
	Low Pressure	High Pressure	Electric current during operation	Low Pressure	High Pressure	Electric current during operation
Insufficient refrigerant (gas leakage)	↘	↘	↘	↘	↘	↘
Clogged capillary tube or Strainer	↘	↘	↘	↘	↘	↘
Short circuit in the indoor unit	↘	↘	↘	↗	↗	↗
Heat radiation deficiency of the outdoor unit	↗	↗	↗	↘	↘	↘
Inefficient compression	↗	↘	↘	↗	↘	↘

- Carry out the measurements of pressure, electric current, and temperature fifteen minutes after an operation is started.

13.1.2. Diagnosis methods of a malfunction of a compressor and 4-way valve

Nature of fault	Symptom
Insufficient compressing of a compressor	<ul style="list-style-type: none"> • Electric current during operation becomes approximately 20% lower than the normal value. • The discharge tube of the compressor becomes abnormally hot (normally 70 to 90°C). • The difference between high pressure and low pressure becomes almost zero.
Locked compressor	<ul style="list-style-type: none"> • Electric current reaches a high level abnormally, and the value exceeds the limit of an ammeter. In some cases, a breaker turns off. • The compressor is a humming sound.
Inefficient switches of the 4-way valve	<ul style="list-style-type: none"> • Electric current during operation becomes approximately 80% lower than the normal value. • The temperature difference between from the discharge tube to the 4-way valve and from suction tube to the 4-way valve becomes almost zero.

14 Technical Data

■ Thermostat characteristics

CS-V28BKP5

• Cooling

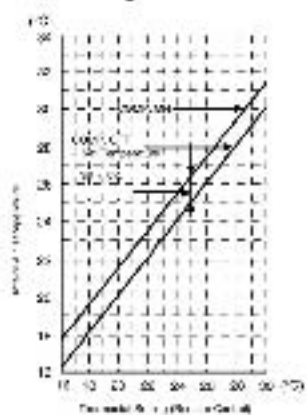

• Soft Dry

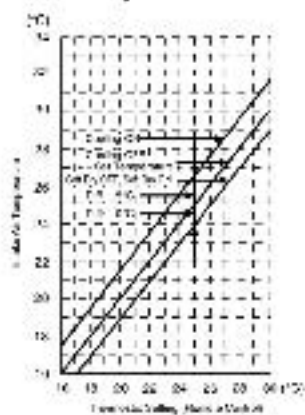

■ Operation characteristics

CS-V28BKP5 / CU-V28BKP5

220V

● Cooling Characteristic

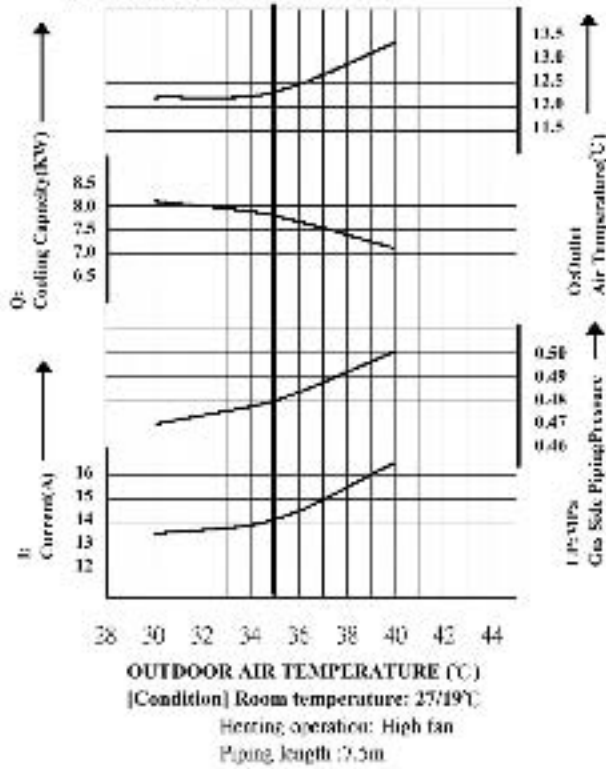

220V

● Piping Length Characteristic (Cooling)

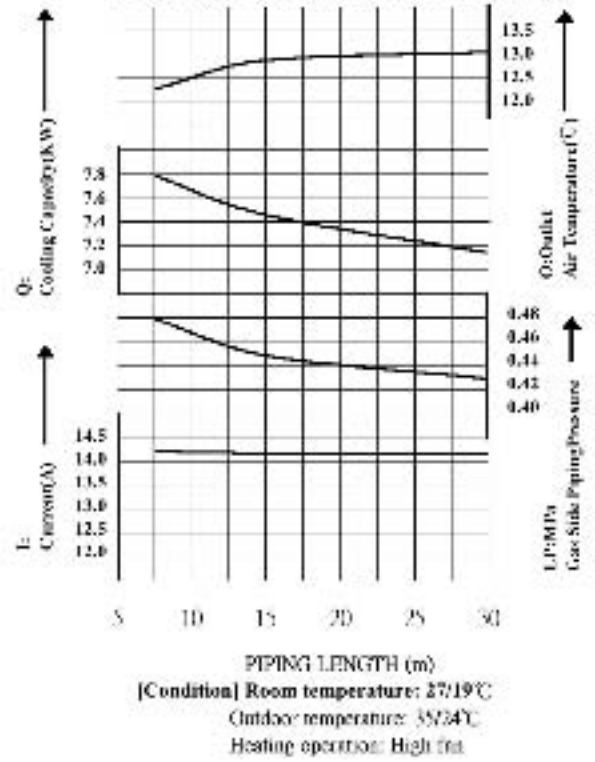

230V

● Cooling Characteristic

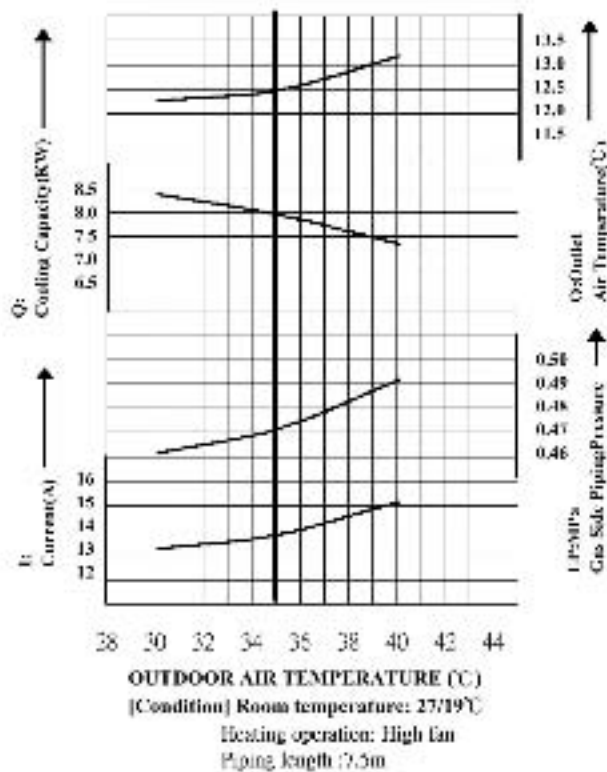

230V

● Piping Length Characteristic (Cooling)

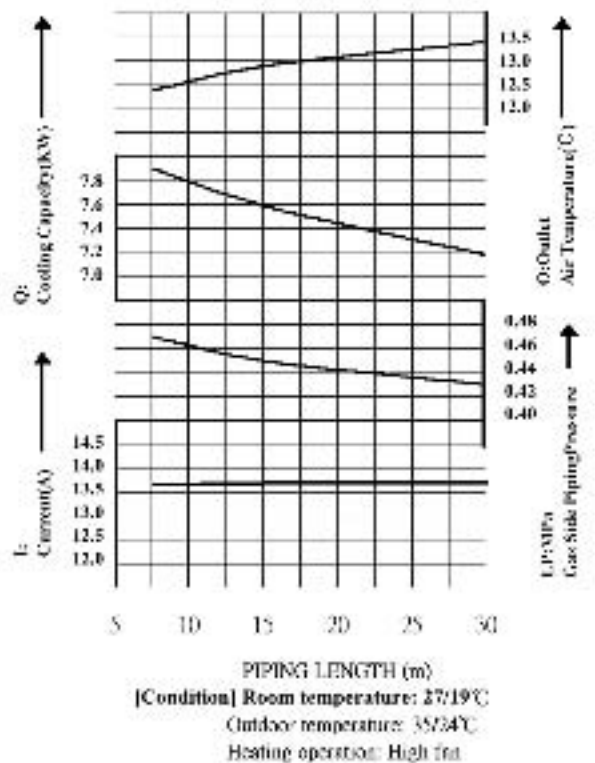

15 Exploded View

CS-V28BKP5

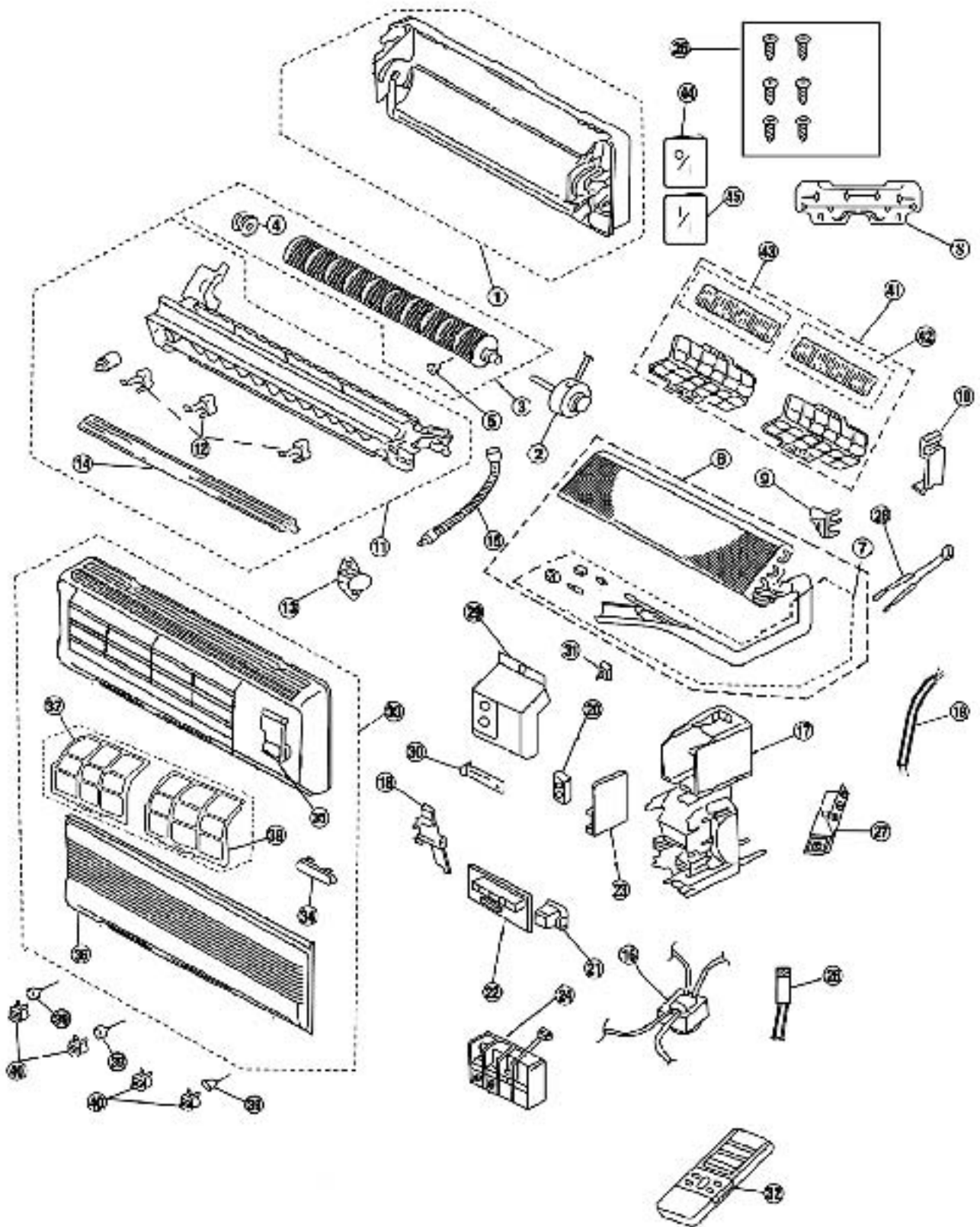

16 Replacement Parts List

<Model: CS-V28BKP5>

NO	DESCRIPTION & NAME	QTY	CS-V28BKP5	REMARKS
1	CHASSIS COMPLETE	1	CWC5239-970	●
2	FAN MOTOR	1	CWC4301-370	■●
3	CROSS FLOW FAN COMPLETE	1	CWC5707-260	●
4	BEARING ASS'Y	1	CWC4059-190	●
5	SCREW (CROSS FLOW FAN)	1	CWC4582-660	●
6	EVAPORATOR COMPLETE ASS'Y	1	CWC6325-350	●
7	TUBE ASS'Y COMPLETE	1	CWC5811-770	●
8	INSTALLATION PLATE	1	CWC8010-540	●
9	SENSOR HOLDER	1	CWC5040-130	●
10	PARTICULAR PLATE	1	CWC4945-610	●
11	DISCHARGE GRILLE COMPLETE	1	CWC5011-920	●
12	FULCRUM	3	CWC4525-110	●
13	MOTOR - AIR SWING	1	CWC4107-010	■●
14	VANE AIR DEFLECTOR ASS'Y	1	CWC5050-870	●
15	DRAIN HOSE	1	CWC5881-720	●
16	TRANSFORMER	1	CWC4017-690	●
17	CONTROL BOARD ASS'Y	1	CWC4719-220	●
18	PARTICULAR PLATE	1	CWC4945-600	■●
19	POWER SUPPLY COMPLETE	1	CWC4102-760	■●
20	CIRCUIT ASS'Y (OPERATION BUTTON COMPLETE)	1	CWC3919-720	■●
21	CIRCUIT ASS'Y (RECEIVER COMPLETE)	1	CWC3919-640	■●
22	CIRCUIT ASS'Y (DISPLAY COMPLETE)	1	CWC3919-710	■●
23	CIRCUIT ASS'Y (ELECTRONIC CONTROLLER)	1	CWC3919-390A	■●
24	TERMINAL BOARD ASS'Y	1	CWC4706-630	■●
25	BAG COMPLETE - INSTALLATION SCREW	1	CWC4649-210	●
26	FUSE COMPLETE	1	CWC4023-070	■●
27	TERMINAL BOARD COMPLETE	1	CWC4706-620	●
28	SENSOR COMPLETE	1	CWC3900-230	■●
29	CONTROL BOARD TOP COVER	1	CWC4945-590	●
30	HOLDER - P.S. CORD	1	CWC4627-040	●
31	CAP (BUTTON)	1	CWC5060-120	■●
32	REMOTE CONTROL COMPLETE ASS'Y	1	CWA75C560	■▲
33	FRONT GRILLE COMPLETE	1	CWC5053-360	■●
34	DECORATING PLATE COMPLETE	1	CWC5027-410	●
35	DOOR	1	CWC5002-270	●
36	INTAKE GRILLE COMPLETE	1	CWC5010-960	●
37	AIR FILTER (LEFT)	1	CWD4209550	■●
38	AIR FILTER (RIGHT)	1	CWD4209540	■●
39	SCREW - FRONT GRILLE	4	XTT4+16C	●
40	CAP (FRONT GRILLE COMPLETE)	4	CWC5060-060	●
41	BAG COMPLETE (AIR PURIFYING FILTER)	1	CWC4649-920	●
42	SOLAR REFRESHING DEODORIZING FILTER	1	CZ-SFD71P	●
43	CATECHIN AIR PURIFYING FILTER	1	CZ-SF71P	●
44	OPERATING INSTRUCTIONS	1	CWC8037-120	●
45	INSTALLATION INSTRUCTIONS	1	CWC8039-280	●

(Note)

- “■” marked parts are recommended to be kept in stock.
- “●” marked parts are supplied from TAMACO, Taiwan.
- “▲” marked parts are supplied from MACC, Malaysia.

17 ExplodedView

CU-V28BKP5

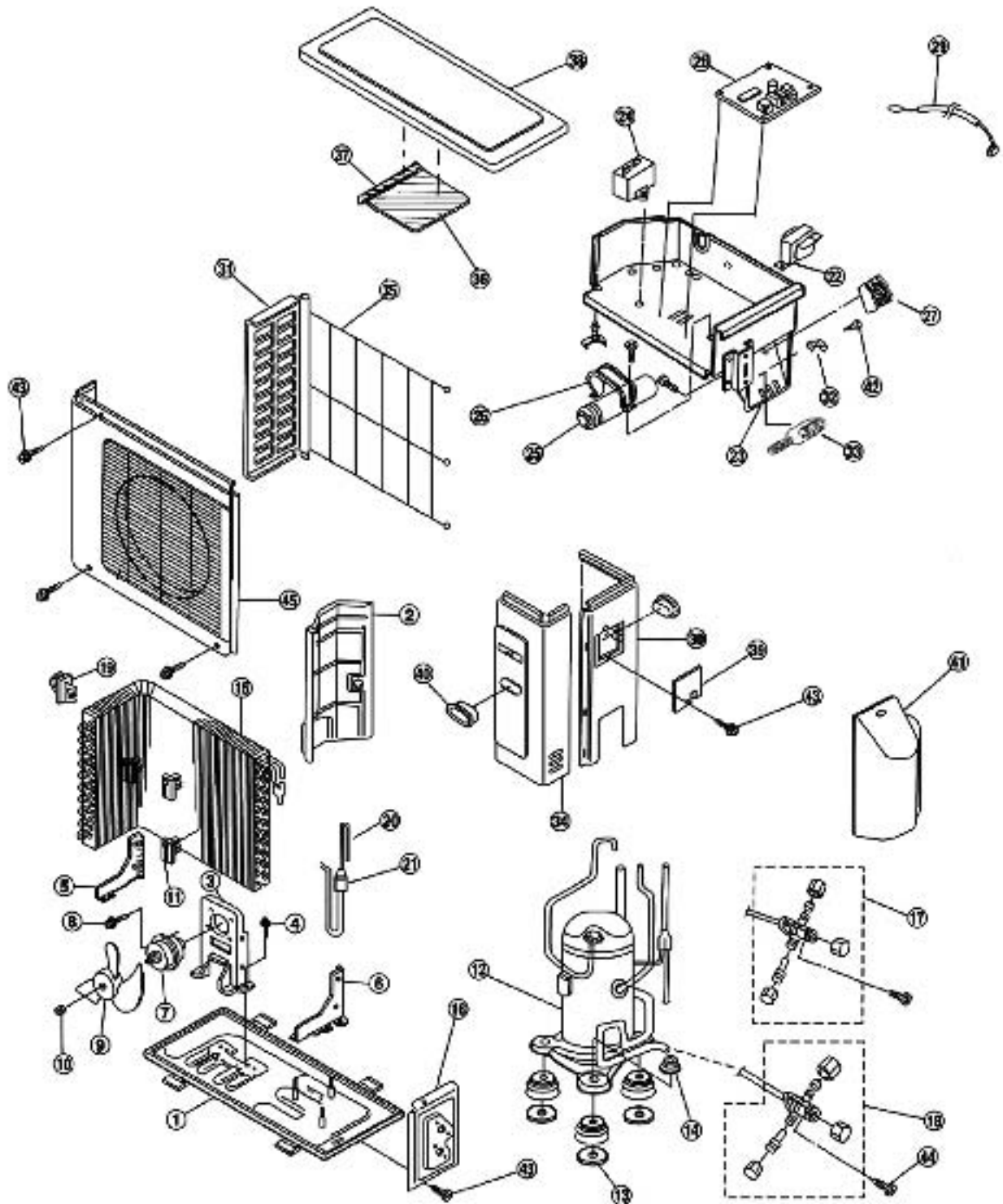

18 Replacement Parts List

<Model: CU-V28BKP5>

NO	DESCRIPTION & NAME	QTY	CU-V28BKP5	REMARKS
1	CHASSIS ASS'Y	1	CWC5244-200A	●
2	SOUND PROOF	1	CWC5236-060	●
3	FAN MOTOR BRACKET	1	CWC5241-830	●
4	SCREW - (FAN MOTOR BRACKET)	6	XTT4D10CXW	●
5	PARTICULAR PLATE - LEFT (HOLD - FAN MOTOR)	1	CWC4934-850	●
6	PARTICULAR PLATE - RIGHT (HOLD - FAN MOTOR)	1	CWC4934-860	●
7	FAN MOTOR	1	CWC4301-380	■ ●
8	SCREW - FAN MOTOR	3	XTT4D10CXW	●
9	PROPELLER FAN ASS'Y	1	CWC5700-500	■ ●
10	NUT - PROPELLER FAN	1	CWC4583-020	●
11	HOLDER - FOR F/MOTOR & LEAD WIRES	3	CWC4620-110	●
12	COMPRESSOR	1	CWC6815-410	■ ●
13	PACKING - COMP. MOUNT	3	CWC4604-010	●
14	NUT - COMP. MOUNT	3	CWC4521-130	●
15	CONDENSER	1	CWC6306-120	●
16	HOLDER - COUPLING ASS'Y	1	CWC5240-070A	●
17	3-WAYS VALVE (LIQUID)	1	CWC4066-290	■ ●
18	3-WAYS VALVE (GAS)	1	CWC4066-300	■ ●
19	HOLDER - SENSOR	1	CWC5040-130	●
20	CAPILLARY TUBE.	1	CWC5892-480	●
21	STRAINER	1	CWC4042-370	●
22	TRANSFORMER	1	CWC4017-700	■ ●
23	CONTROL BOARD ASS'Y	1	CWC4712-690	●
24	CAPACITOR - FAN MOTOR	1	CWC4069-960	■ ●
25	CAPACITOR - COMPRESSOR	1	CWC4069-780	■ ●
26	HOLDER - CAPACITOR	1	CWC4828-750	●
27	TERMINAL BOARD ASS'Y	1	CWC4706-640	■ ●
28	ELECTRONIC CONTROLLER	1	CWC3919-680	■ ●
29	SENSOR COMPLETE	1	CWC3900-290	■ ●
30	CABINET REAR PLATE COMPLETE	1	CWC5030-820	●
31	CABINET SIDE PLATE (LEFT)	1	CWC5030-720A	●
32	U METAL PIECE	1	CWC4825-120	●
33	HOLDER-PS, CORD	1	CWC4627-100	●
34	CABINET FORNT PLATE ASS'Y	1	CWC5030-640	●
35	WIRE NET (REAR)	1	CWC4537-530A	●
36	POLY-E FOAM	1	CWE3A325-360	●
37	POLY-E FOAM	1	CWN5A30-325	●
38	CABINET TOP PLATE ASS'Y	1	CWC5030-520A	●
39	CONTROL BOARD COVER	1	CWC4936-960A	●
40	HANDLE	2	CWC4520-120	●
41	RAIN COVER	1	CWC4631-880	●
42	SCREW	1	XYN4+C8D	●
43	SCREW	20	CWC4585-520	●
44	SCREW	4	CWC4580-930	●
45	CABINET ASS'Y	1	CWC5030-940A	●

(Note)

- “■” marked parts are recommended to be kept in stock.
- “●” marked parts are supplied from TAMACO, Taiwan.
- “▲” marked parts are supplied from MACC, Malaysia.

19 Electronic Parts List

Electronic Controller: C3919-390A (CS-V28BKP5)

SYMBOL	DESCRIPTION & NAME	PART NO.
IC1	INTEGRATED CIRCUIT	C4083-920
IC2	INTEGRATED CIRCUIT	C4083-450
IC3	INTEGRATED CIRCUIT	C4083-860
IC4	INTEGRATED CIRCUIT	C4083-730
IC5	INTEGRATED CIRCUIT	
Q1	TRANSISTOR	C4086-060T
Q2	TRANSISTOR	C4086-240T
Q3, Q5	TRANSISTOR	J4086-080T
D1 ~ D4	DIODE	E4060-020T
ZD1	ZENER DIODE	C4082-100T
ZNR1,ZNR3	ZNR	C4084-150
RY-SLO	RELAY ELECTRO MAGNETIC	C4104-180
RY-HI, ME, LO	RELAY ELECTRO MAGNETIC	C4104-170
RY-COMP	RELAY ELECTRO MAGNETIC	C4076-310
SW1, SW2	PUSH SWITCH	C4001-200
FUSE	FUSE	XBA2C31TR0
X1	RESONATOR	F4090-010T
BZ	BUZZER (SOUND GENERATOR)	C4091-030
Q7,Q8	TRANSISTOR	C4086-250T

Note

- All parts are supplied from TAMACO, Taiwan.

Electronic Controller: C3919-680 (CU-V28BKP5)

SYMBOL	DESCRIPTION & NAME	PART NO.
IC1	INTEGRATED CIRCUIT	J4083-070
Q1	TRANSISTOR	J4086-080T
D5	DIODE	E4060-020T
RY-HILO	RELAY	C4104-090

Note

- All parts are supplied from TAMACO, Taiwan.

20 Electronic Circuit Diagram

• CS-V28BKP5 / CU-V28BKP5

SCHEMATIC DIAGRAM 1/3

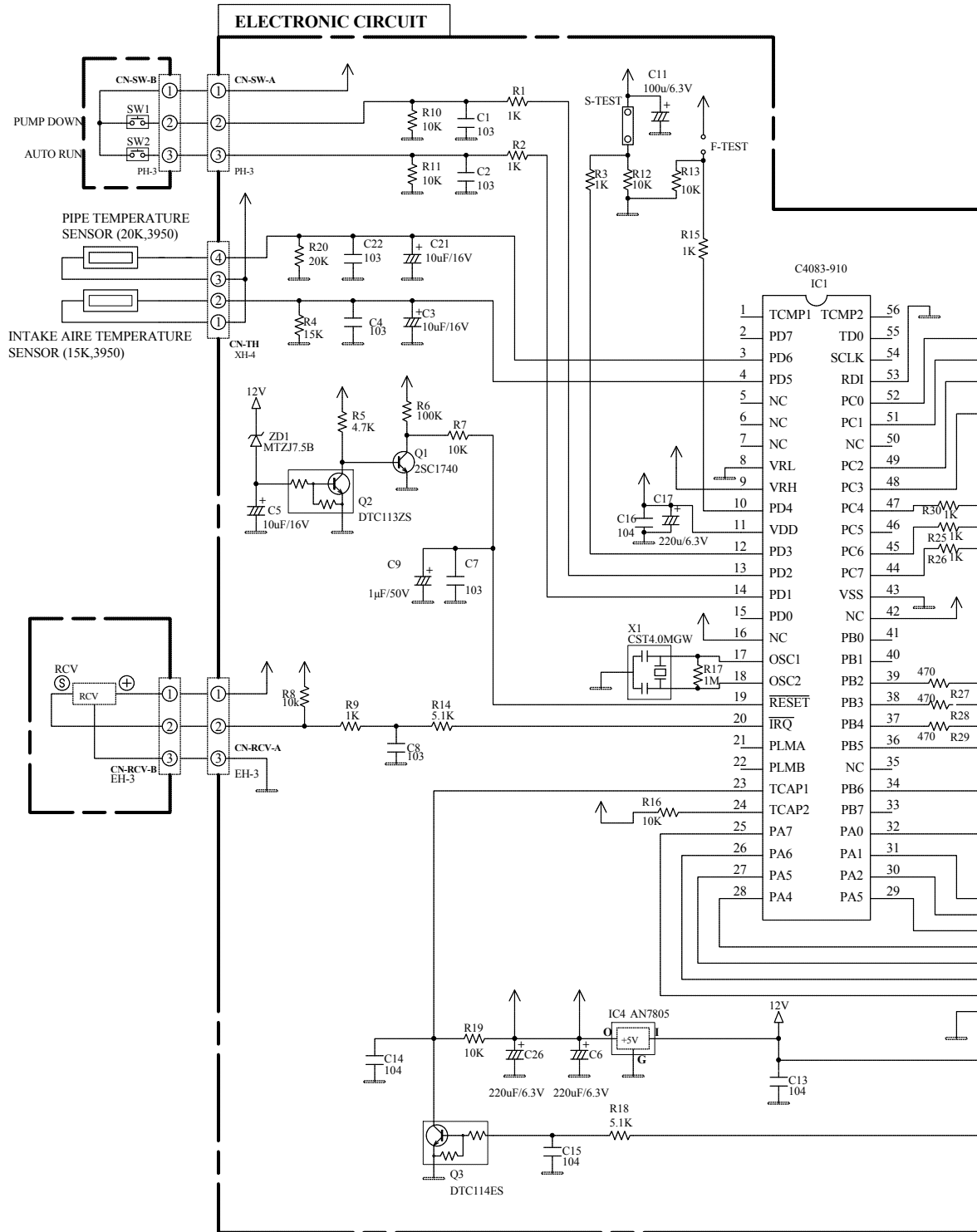

SCHEMATIC DIAGRAM 2/3

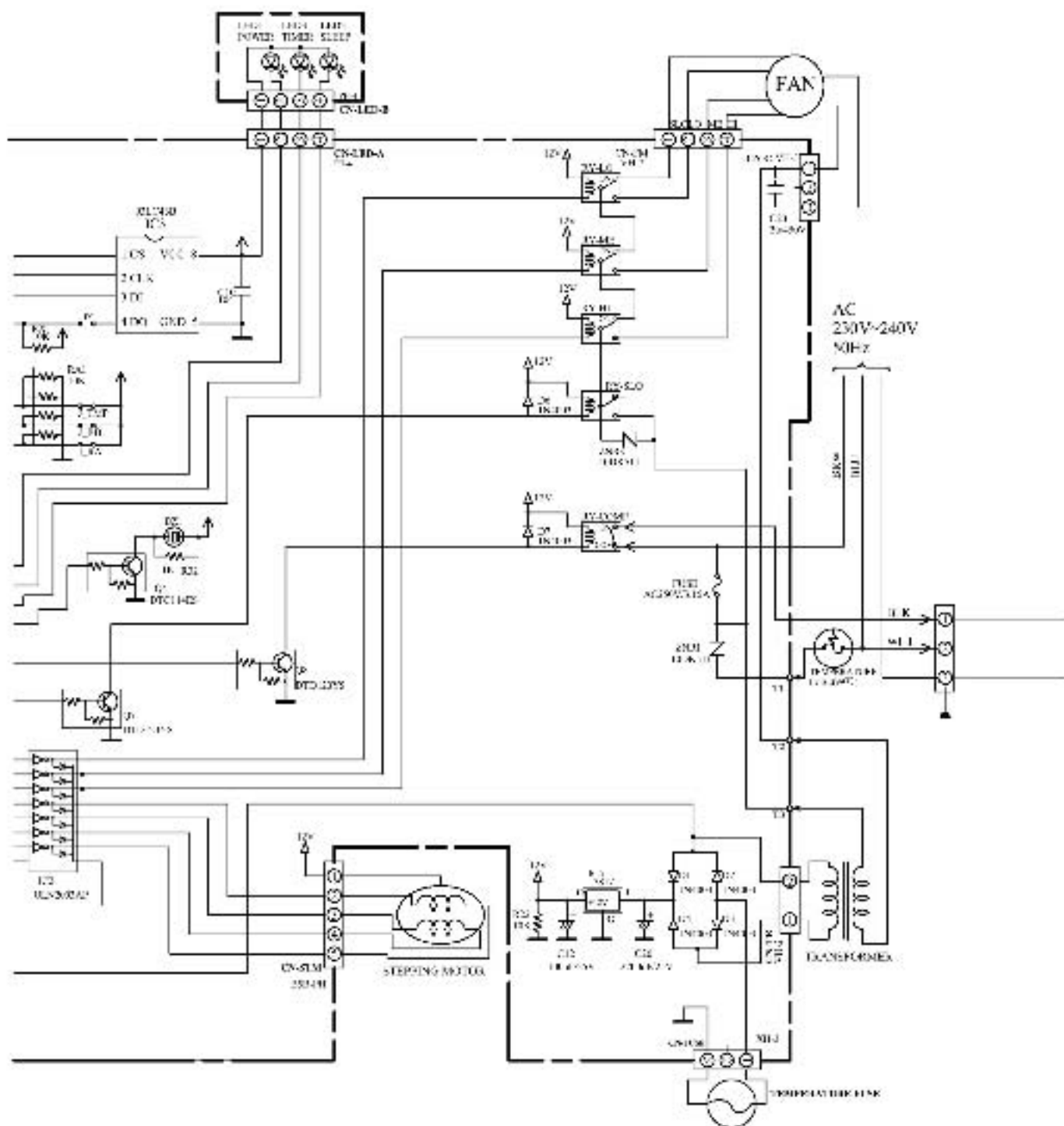

SCHEMATIC DIAGRAM 3/3

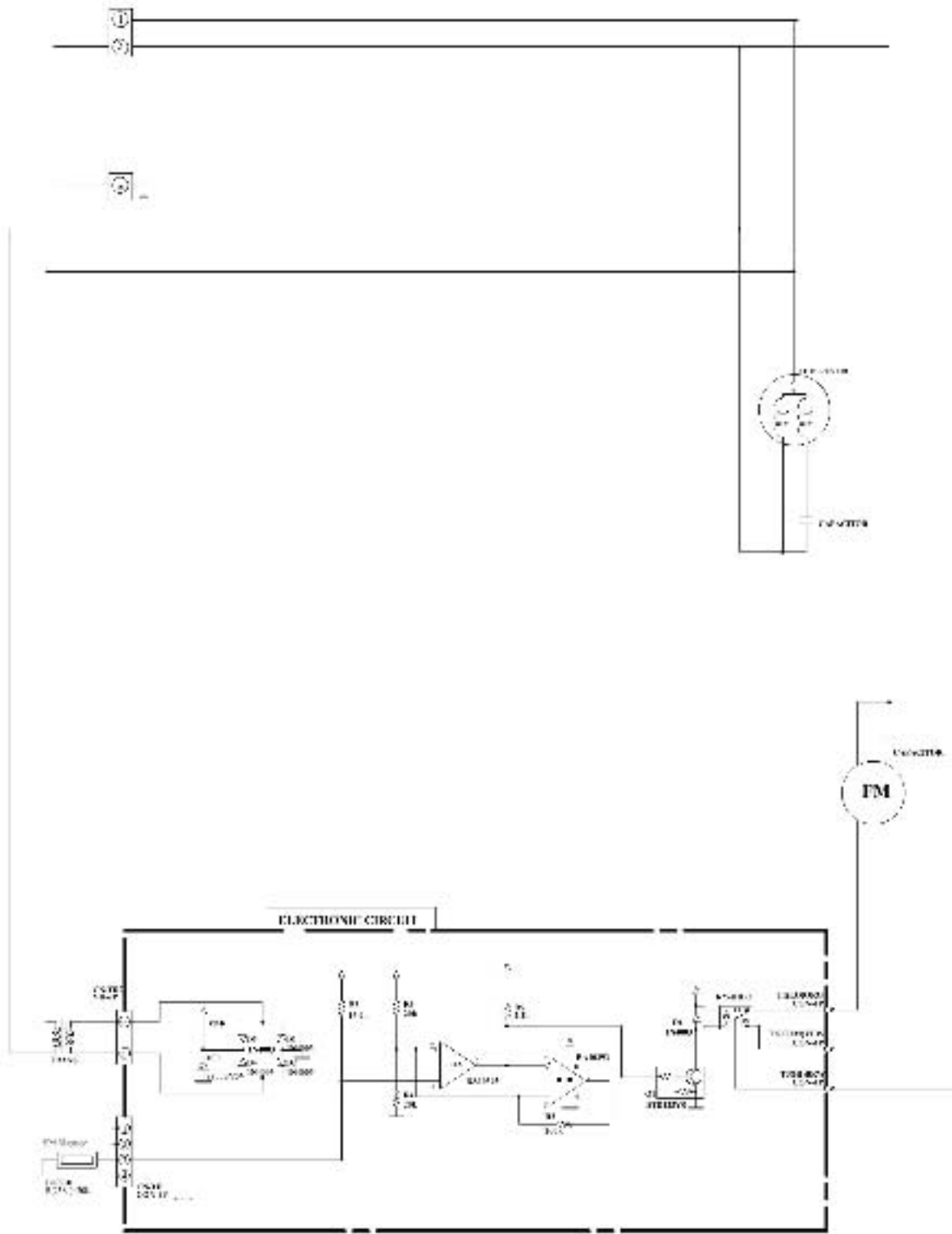

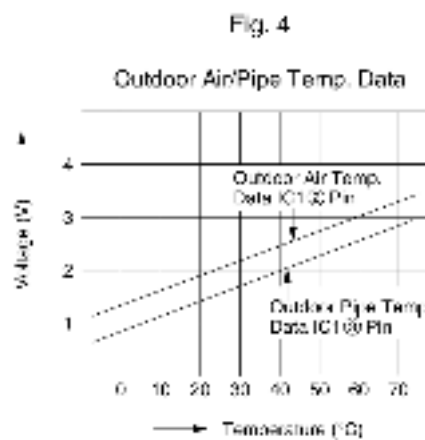
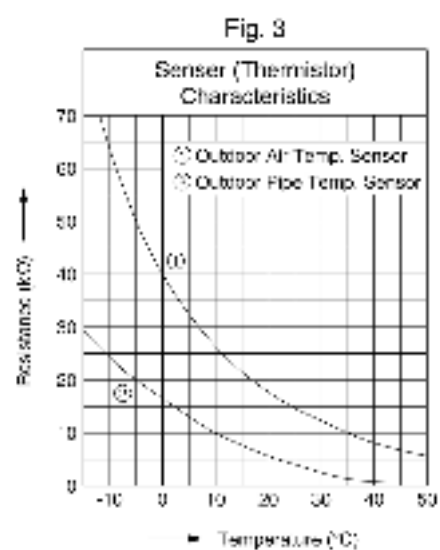
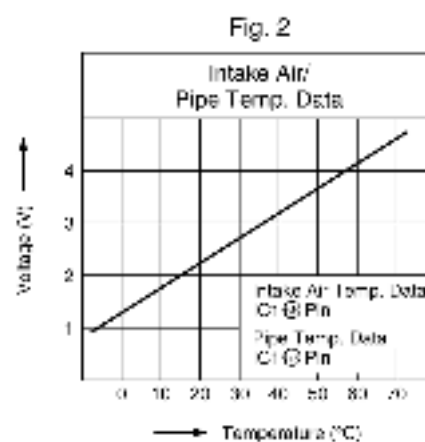
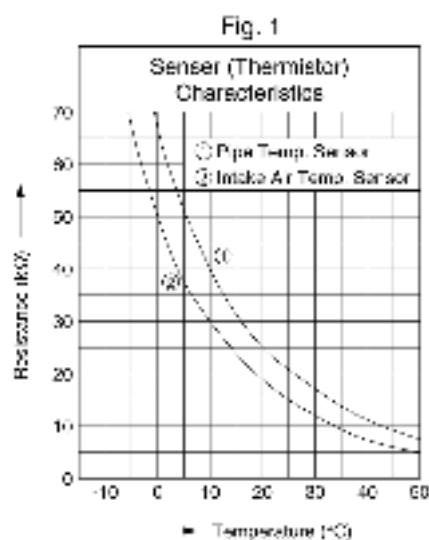

Fig. 5

OUTDOOR TEMP.	HISES		FALLS	
	OVER 25°C	HI	OVER 31°C	HI
COOLING	BELOW 29°C	Lo	BELOW 31°C	Lo
HEATING	BELOW 15.5°C	Hi	BELOW 12.5°C	Hi
	OVER 15.5°C	Lo	OVER 13.5°C	Lo

How to use electronic circuit diagram

Before using the circuit diagram, read the following carefully.

* Voltage measurement

Voltage has been measured with a digital tester when the indoor fan is set at high fan speed under the following conditions without setting the timer.

Use them for servicing.

Voltage indication is in Red at all operations.

	Intake air temperature	Temperature setting	Discharge air temperature	Pipe temperature
Cooling	27°C	16°C	17°C	15°C
Heating	20°C	30°C	40°C	50°C

* Indications for resistance

a. K...kΩ

M...MΩ

W...watt

Not indicated...1/4W

b. Type

Not indicated.....carbon resistor

Tolerance±5%



.....metal oxide resistor

Tolerance±1%

* Indications for capacitor

a. Unit μ...μF P...pF

b. Type Not indicated...ceramic capacitor

(S).....S series aluminium electrolytic capacitor

(Z).....Z series aluminium electrolytic capacitor

(SU).....SU series aluminium electrolytic capacitor

(P).....P series polyester system

(SXE).....SXE series aluminium electrolytic capacitor

(SRA).....SRA series aluminium electrolytic capacitor

(KME).....KME series aluminium electrolytic capacitor

* Diode without indication.....MA165

* Circuit Diagram is subject to change without notice for further development.

TIMER TABLE

Name		Time	Test mode (When test point Short-circuited)	Remarks
Sleep Mode Waiting		1 hr.	6 sec.	
Sleep Mode Operation		8 hrs.	48 sec.	
Real Timer		1 hr.	1 min.	
		10 min.	10 sec.	
		1 min.	1 sec.	
Time Delay Safety Control		3 min.	0 sec.	
Forced Operation		60 sec.	0 sec.	
Time Save Control		7 min.	42 sec.	
Anti-Freezing Control		4 min.	0 sec.	
Mode Judgement		20 sec.	0 sec.	
Soft Dry	Off	6 min.	36 sec.	
	On	10 min.	60 sec.	SOFT DRY: 10 min. operation
Deodorizing Control	Cooling	40 sec.	4 sec.	Comp. ON
		70 sec.	7 sec.	Comp. ON
		20 sec.	2 sec.	Comp. OFF
	Soft Dry	180 sec.	18 sec.	Comp. OFF
		40 sec.	4 sec.	Comp. ON
		360 sec.	36 sec.	Comp. OFF

20.1. REMOTE CONTROL

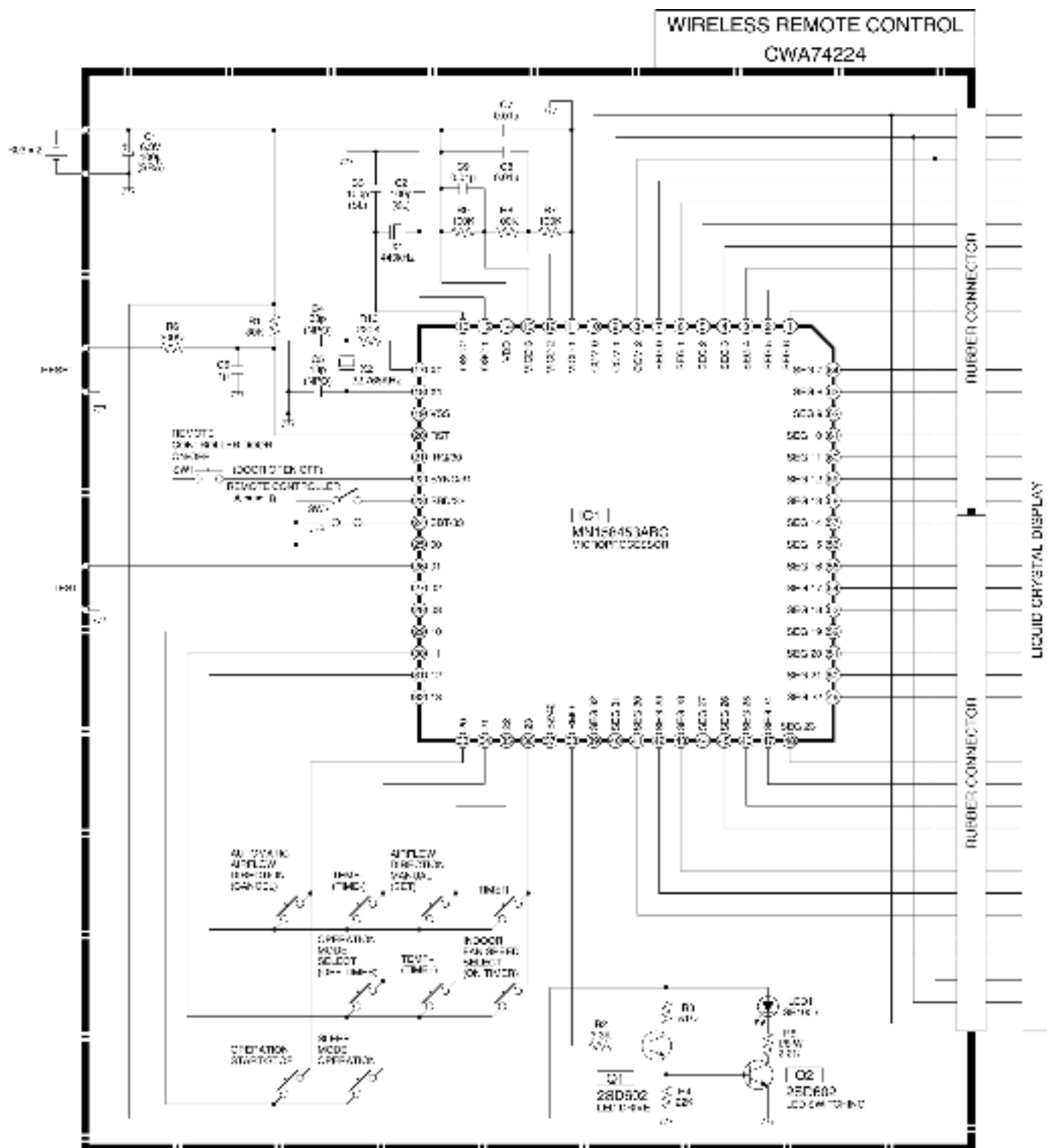

REMOTE CONTROL NO.	SW1	SW2	SW3	SW4	SW5
1	ON	ON	ON	ON	ON
2	ON	ON	ON	ON	ON
3	ON	ON	ON	ON	ON

ON: THIS MARK INDICATES ALTERNATIVE