

Service Manual

Room Air Conditioner

CS-W18CKP CU-W18CKP5
CS-W24CKP CU-W24CKP5



⚠ WARNING

This service information is designed for experienced repair technicians only and is not designed for use by the general public. It does not contain warnings or cautions to advise non-technical individuals of potential dangers in attempting to service a product. Products powered by electricity should be serviced or repaired only by experienced professional technicians. Any attempt to service or repair the product or products dealt with in this service information by anyone else could result in serious injury or death.

⚠ PRECAUTION OF LOW TEMPERATURE

In order to avoid frostbite, be assured of no refrigerant leakage during the installation or repairing of refrigeration circuit.

CONTENTS

	Page		Page
1 Features	2	11 Installation and Servicing Air Conditioner Using R410A	45
2 Functions	3	12 Servicing Information	56
3 Product Specifications	6	13 Troubleshooting Guide	60
4 Dimensions	10	14 Technical Data	62
5 Refrigeration Cycle Diagram	12	15 Exploded View	66
6 Block Diagram	13	16 Replacement Parts List	67
7 Wiring Diagram	14	17 Exploded View	68
8 Operation Details	15	18 Replacement Parts List	69
9 Operating Instructions	30	19 Electronic Circuit Diagram	70
10 Installation Instructions	35		

Panasonic

© 2002 Matsushita Industrial Corp. Sdn. Bhd. (11969-T). All rights reserved. Unauthorized copying and distribution is a violation of law.

1 Features

- **High Efficiency**
- **Compact Design**
- **Comfort Environment**
 - 8 hours of sleep mode operation
 - Air filter with function to reduce dust and smoke
 - Wider range of horizontal discharge air
 - New Automatic air swing and manual adjusted by remote control for horizontal airflow.
- **Auto Restart**
 - Random auto restart after power failure for safety restart operation
- **Removable and Washable Front Panel**
- **Remote Control Self-illuminating Button**
- **Catechin Air Purifying Filter**
 - Trap dust, tobacco smoke and tiny particles
 - Prevent the growth of bacteria and viruses trapped
- **Solar Refreshing Deodorizing Filter**
 - Remove unpleasant odour from the air
- **Quality Improvement**
 - Gas leakage protection
 - Prevent compressor reverse cycle
 - Inner protector
 - Noise prevention during soft dry operation.
 - Anti-dew Formation Control (Cooling & Soft Dry)
 - Overload Protection Control (Heating)
 - Outdoor Fan Control
 - Compressor High Pressure Control
 - Blue Coated Condenser
 - High resistance to corrosion.
- **Operation Improvement**
 - Economy mode to reduce electrical power consumption
 - Powerful mode to reach the desired room temperature quickly
- **Long Installation Piping**
 - Long piping up to 25 meter
- **24-hour Timer Setting**
- **Environmental Friendly**
 - R410A, which does not contain chlorine, is used as its refrigerant, so there is no danger of damage to the ozone layer in stratosphere.

2 Functions

Remote Control

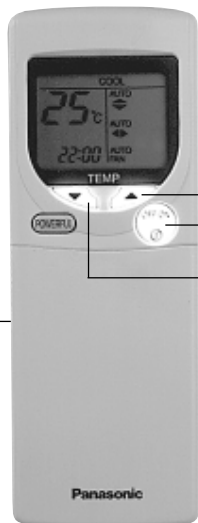

Self illuminating button

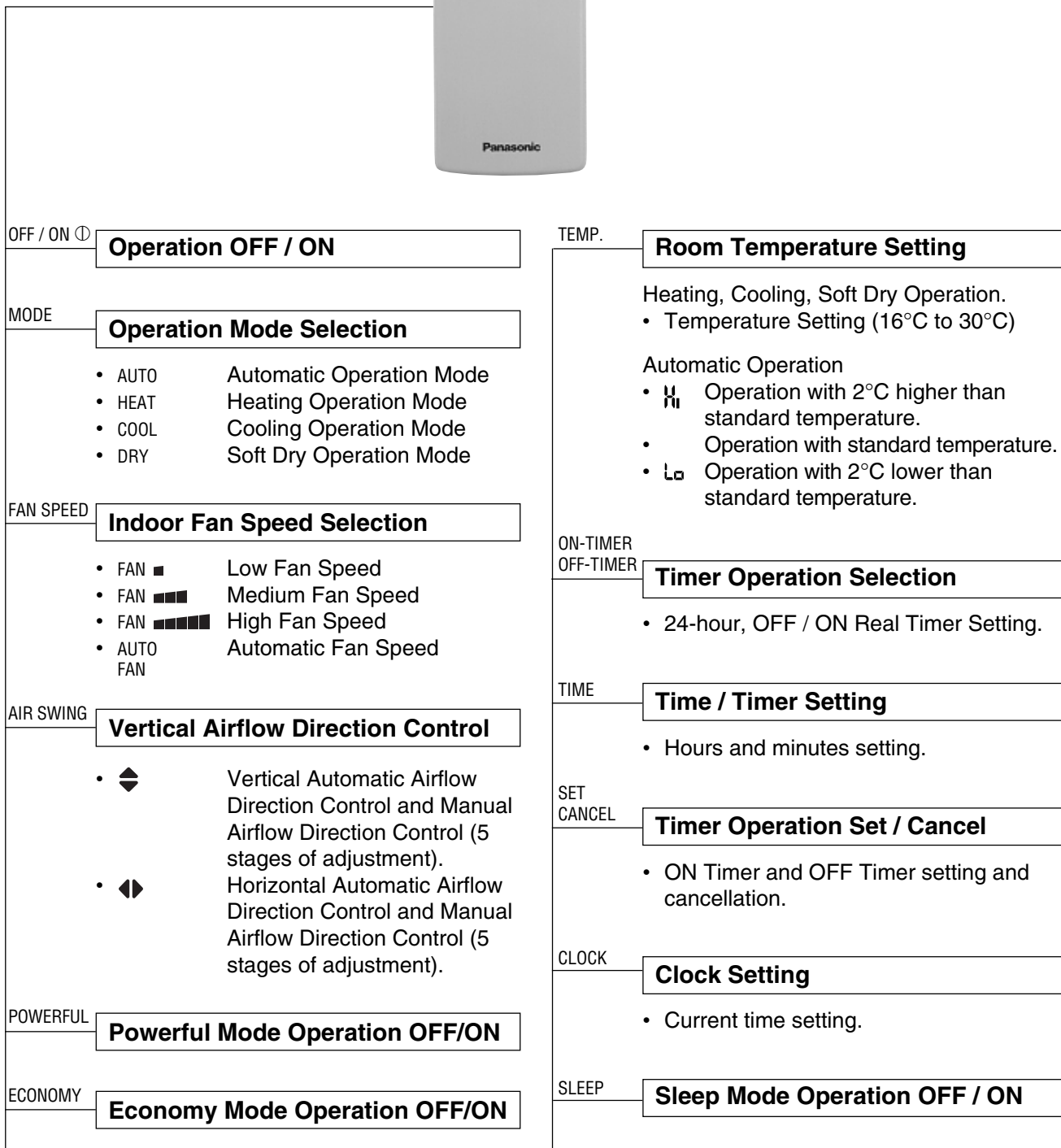

Indoor Unit



AUTO
OFF / ON

Automatic Operation Button

- Press for < 5s to operate Automatic operation mode.
(Used when the remote control cannot be used.)
- Press continuously for 5s or < 10s to operate Test Run/Pump down. "Beep" sound will be heard at the 5th second.
(Used when test running or servicing.)
- Press continuously for 10s and above to omit or resume the remote control signal receiving sound. "Beep, beep" sound will be heard at the 10th second.

Operation Indication Lamps (LED)

- POWER (Green) Lights up in operation, blinks in Automatic Operation Mode judging and Hot Start operation.
- SLEEP (Orange) Lights up in Sleep Mode Operation.
- TIMER (Orange) Lights up in Timer Setting.
- POWERFUL (Orange) ... Lights up in Powerful Mode Operation.
- ECONOMY (Green) Lights up in Economy Mode Operation.

Operation Mode

- Heating, Cooling, Soft Dry and Automatic Mode.

Powerful Operation

- Reaches the desired room temperature quickly.

Economy Operation

- To reduce electrical power consumption.

Random Auto Restart Control

- Operation is restarted randomly after power failure at previous setting mode.

Anti-Freezing Control

- Anti-Freezing control for indoor heat exchanger. (Cooling and Soft Dry)

Sleep Mode Auto Control

- Indoor Fan operates refer to Indoor Fan Speed control.
- Operation stops after 8 hours.

Indoor Fan Speed Control

- High, Medium and Low.
- Automatic Fan Speed Mode
 - Heating : Fan speed varies from Me → SLo in accordance with indoor heat exchanger.
 - Cooling : Fan rotates at Hi, Me and SLo speed. Deodorizing control is available.
 - Soft Dry : Fan rotates at SLo speed. Deodorizing control is available.

Airflow Direction Control

- Automatic air swing and manual adjusted by remote control for vertical and horizontal airflow.

Time Delay Safety Control

- Restarting is inhibited for approx. 3 minutes.

7 Minutes Time Save Control

- Cooling Operation only.

Anti-Dew Formation Control

- Anti-Dew Formation Control for indoor unit discharge area.

Hot-Start Control

- At Heating Operation the indoor fan will operate at SLo speed when indoor heat exchanger temperature reaches 30°C.

Anti Cold Draft Control

- The indoor fan operates at Lo (30 sec.) after that SLo when the indoor heat exchanger temperature is low. (During Heating mode thermal off)

Outdoor Unit



Compressor Reverse Rotation Protection Control

- To protect compressor from reverse rotation when there is a instantaneous power failure.

Overload Protector

- Inner protector.

60 Secs. Forced Operation Control

- Once the compressor is activated, it does not stop within the first 60 secs. However, it stops immediately with remote control stop signal.

Outdoor Fan Operation Control

- 6-pole induction motor (2 speed).
- For Cooling or Soft Dry operation
Hi-speed When outdoor temperature reaches to 31°C.
Lo-speed When outdoor temperature reaches to 29°C.
- For Heating operation
Hi-speed When outdoor temperature reaches to 13.5°C.
Lo-speed When outdoor temperature reaches to 15.5°C.
- For Over-heating Protection, the Fan is switched ON or OFF depending on the piping temperature and the outdoor temperature.



Deice Control

- To prevent frosting at outdoor heat exchanger during Heating Operation.

4-Way Valve Control

- When the unit is switched to "OFF" during Heating Operation, 4-way valve stays at Heating position for 5 minutes.

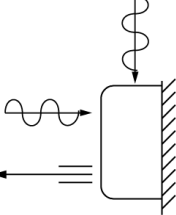
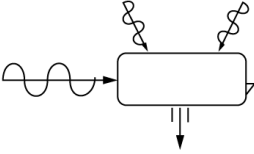

3 Product Specifications

		Unit	CS-W18CK	CU-W18CK
Power Source		Phase, Voltage, Cycle	Single, 230, 50 Hz	
Cooling Capacity		kW (BTU/h)	5.30 (18,100)	
Heating Capacity		kW (BTU/h)	5.55 (18,900)	
Moisture Removal		l/h (Pint/h)	2.9 (6.1)	
Airflow Method		<p>OUTLET</p>  <p>INTAKE</p> 	<p>SIDE VIEW</p> 	<p>TOP VIEW</p> 
Air Volume	Indoor Air (Lo)	m ³ /min (cfm)	Cooling; 13.3 (470) Heating; 14.2 (500)	—
	Indoor Air (Me)	m ³ /min (cfm)	Cooling; 14.8 (520) Heating; 14.8 (520)	—
	Indoor Air (Hi)	m ³ /min (cfm)	Cooling; 15.6 (550) Heating; 16.4 (580)	40.0 (1,410)
	Indoor Air (SHi)	m ³ /min (cfm)	Cooling; 16.4 (580) Heating; 16.4 (580)	—
Noise Level		dB (A)	Cooling; High 43, Low 38 Heating; High 42, Low 38	Cooling; High 55 Heating; High 56
		Power level dB	Cooling; 55 Heating; 53	Cooling; 68 Heating; 69
Electrical Data	Input Power	kW	Cooling; 1.65 Heating; 1.70	
	Running Current	A	Cooling; 7.4 Heating; 7.6	
	EER	W/W (BTU/hW)	Cooling; 3.21 (10.95)	
	COP	W/W (BTU/hW)	Heating; 3.26 (11.13)	
	Starting Current	A	27.0	
Piping Connection Port (Flare piping)		inch inch	G ; Half Union 1/2" L ; Half Union 1/4"	G ; 3-way valve 1/2" L ; 3-way valve 1/4"
Pipe Size (Flare piping)		inch inch	G ; (gas side) 1/2" L ; (liquid side) 1/4"	G ; (gas side) 1/2" L ; (liquid side) 1/4"
Drain Hose	Inner diameter	mm	12	—
	Length	mm	650	—
Power Cord	Length	m	1.9	—
	Number of core-wire		3 (1.5 mm ²)	—
Dimensions	Height	inch (mm)	10 - 13/16 (275)	26 - 31/32 (685)
	Width	inch (mm)	39 - 9/32 (998)	31 - 1/2 (800)
	Depth	inch (mm)	8 - 9/32 (210)	11 - 13/16 (300)
Net Weight		lb (kg)	24 (11.0)	121 (55.0)
Compressor	Type		—	Rotary (1 cylinder) rolling piston type
	Motor Type		—	Induction (2-poles)
	Rated Output	kW	—	1.4

		Unit	CS-W18CK	CU-W18CK	
Air Circulation	Type		Cross-flow Fan	Propeller Fan	
	Material		ASHT-18	PC + AES + Glass Fiber 15%	
	Motor Type		Transistor (8-poles)	Induction (4-poles)	
	Input	W	53.5	130	
	Rated Output	W	30	67	
	Fan Speed	Low	rpm	Cooling; 1,160 Heating; 1,240	640
		Medium	rpm	Cooling; 1,290 Heating; 1,290	—
High		rpm	Cooling; 1,360 Heating; 1,400	1,000	
SuperHigh		rpm	Cooling; 1,400 Heating; 1,400	—	
Heat Exchanger	Description		Evaporator	Condenser	
	Tube material		Copper	Copper	
	Fin material		Aluminium (Pre Coat)	Aluminium (Blue Coat)	
	Fin Type		Slit Fin	Corrugated Fin	
	Row / Stage		(Plate fin configuration, forced draft)		
			2 x 15	2 x 26	
	FPI		21	16	
Size (W x H x L)	mm	810 x 315 x 25.4	769.2 x 660.4 x 44 732.9		
Refrigerant Control Device			—	Capillary Tube	
Refrigeration Oil		(cm ³)	—	RB68A OR FREOL ALPHA 68M	
Refrigerant (R410A)		g (oz)	—	1,620 (57.2)	
Thermostat			Electronic Control	Mechanical Control	
Protection Device			—	Inner Protector	
Capillary Tube	Length	mm	—	Cooling; 1,180, Heating; 1,048	
	Flow Rate	l/min	—	Cooling; 8.7, Heating; 14.0	
	Inner Diameter	mm	—	Cooling; 1.5, Heating; 1.8	
Air Filter	Material		P.P.	—	
	Style		Honeycomb		
Capacity Control			Capillary Tube		
Compressor Capacitor		µF, VAC	—	50 µF, 370VAC	
Fan Motor Capacitor		µF, VAC	—	3.0 µF, 450VAC	

Note:

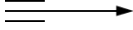
- Specifications are subject to change without notice for further improvement.

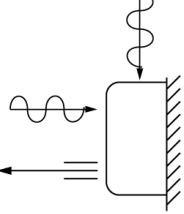
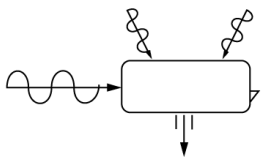
		Unit	CS-W24CK	CU-W24CK
Power Source		Phase, Voltage, Cycle	Single, 230, 50 Hz	
Cooling Capacity		kW (BTU/h)	7.03 (24,000)	
Heating Capacity		kW (BTU/h)	7.72 (26,300)	
Moisture Removal		l/h (Pint/h)	4.0 (8.5)	
Airflow Method		<p>OUTLET</p>  <p>INTAKE</p> 	<p>SIDE VIEW</p> 	<p>TOP VIEW</p> 
Air Volume	Indoor Air (Lo)	m ³ /min (cfm)	Cooling; 14.4 (510) Heating; 15.6 (550)	—
	Indoor Air (Me)	m ³ /min (cfm)	Cooling; 16.4 (580) Heating; 16.4 (580)	—
	Indoor Air (Hi)	m ³ /min (cfm)	Cooling; 17.5 (620) Heating; 18.1 (640)	Cooling; 47.2 (1,670)
	Indoor Air (SHi)	m ³ /min (cfm)	Cooling; 18.1 (640) Heating; 18.1 (640)	—
Noise Level		dB (A)	Cooling; High 47, Low 41 Heating; High 46, Low 41	Cooling; High 60 Heating; High 61
		Power level dB	Cooling; 59 Heating; 57	Cooling; 74 Heating; 74
Electrical Data	Input Power	kW	Cooling; 2.78 Heating; 2.69	
	Running Current	A	Cooling; 13.1 Heating; 12.9	
	EER	W/W (BTU/hW)	Cooling; 2.53 (8.63)	
	COP	W/W (BTU/hW)	Heating; 2.87 (9.79)	
Starting Current		A	65.0	
Piping Connection Port (Flare piping)		inch inch	G ; Half Union 5/8" L ; Half Union 1/4"	G ; 3-way valve 5/8" L ; 3-way valve 1/4"
Pipe Size (Flare piping)		inch inch	G ; (gas side) 5/8" L ; (liquid side) 1/4"	G ; (gas side) 5/8" L ; (liquid side) 1/4"
Drain Hose	Inner diameter	mm	12	—
	Length	mm	650	—
Power Cord	Length	m	1.9	—
	Number of core-wire		3 (2.5 mm ²)	—
Dimensions	Height	inch (mm)	10 - 13/16 (275)	26 - 31/32 (685)
	Width	inch (mm)	39 - 9/32 (998)	31 - 1/2 (800)
	Depth	inch (mm)	8 - 9/32 (210)	11 - 13/16 (300)
Net Weight		lb (kg)	24 (11.0)	135 (61.0)
Compressor	Type		—	Rotary (1 cylinder) rolling piston type
	Motor Type		—	Induction (2-poles)
	Rated Output	kW	—	2.2

		Unit	CS-W24CK	CU-W24CK	
Air Circulation	Type		Cross-flow Fan	Propeller Fan	
	Material		ASHT-18	PC + AES + Glass Fiber 15%	
	Motor Type		Transistor (8-poles)	Induction (4-poles)	
	Input	W	53.5	190.0	
	Rated Output	W	30	108	
	Fan Speed	Low	rpm	Cooling; 1,260 Heating; 1,360	680
		Medium	rpm	Cooling; 1,430 Heating; 1,430	—
		High	rpm	Cooling; 1,530 Heating; 1,580	1,170
SuperHigh		rpm	Cooling; 1,580 Heating; 1,580	—	
Heat Exchanger	Description		Evaporator	Condenser	
	Tube material		Copper	Copper	
	Fin material		Aluminium (Pre Coat)	Aluminium (Blue Coat)	
	Fin Type		Slit Fin	Corrugated Fin	
	Row / Stage		(Plate fin configuration, forced draft)		
			2 x 15	2 x 26	
	FPI		21	16	
Size (W x H x L)	mm	810 x 315 x 25.4	769.2 x 660.4 x 44.0 732.9		
Refrigerant Control Device			—	Capillary Tube	
Refrigeration Oil		(cm ³)	—	RB68A OR FRE0L ALPHA 68M	
Refrigerant (R410A)		g (oz)	—	1,780 (62.8)	
Thermostat			Electronic Control	Mechanical Control	
Protection Device			—	Inner Protector	
Capillary Tube	Length	mm	—	Cooling; 663, Heating; 550	
	Flow Rate	l/min	—	Cooling; 13.0, Heating; 29.0	
	Inner Diameter	mm	—	Cooling; 1.6, Heating; 2.4	
Air Filter	Material		P.P.	—	
	Style		Honeycomb		
Capacity Control			Capillary Tube		
Compressor Capacitor		μF, VAC	—	45 μF, 370VAC	
Fan Motor Capacitor		μF, VAC	—	3.0 μF, 450VAC	

Note:

- Specifications are subject to change without notice for further improvement.

4 Dimensions

CS-W18CK / CS-W24CK

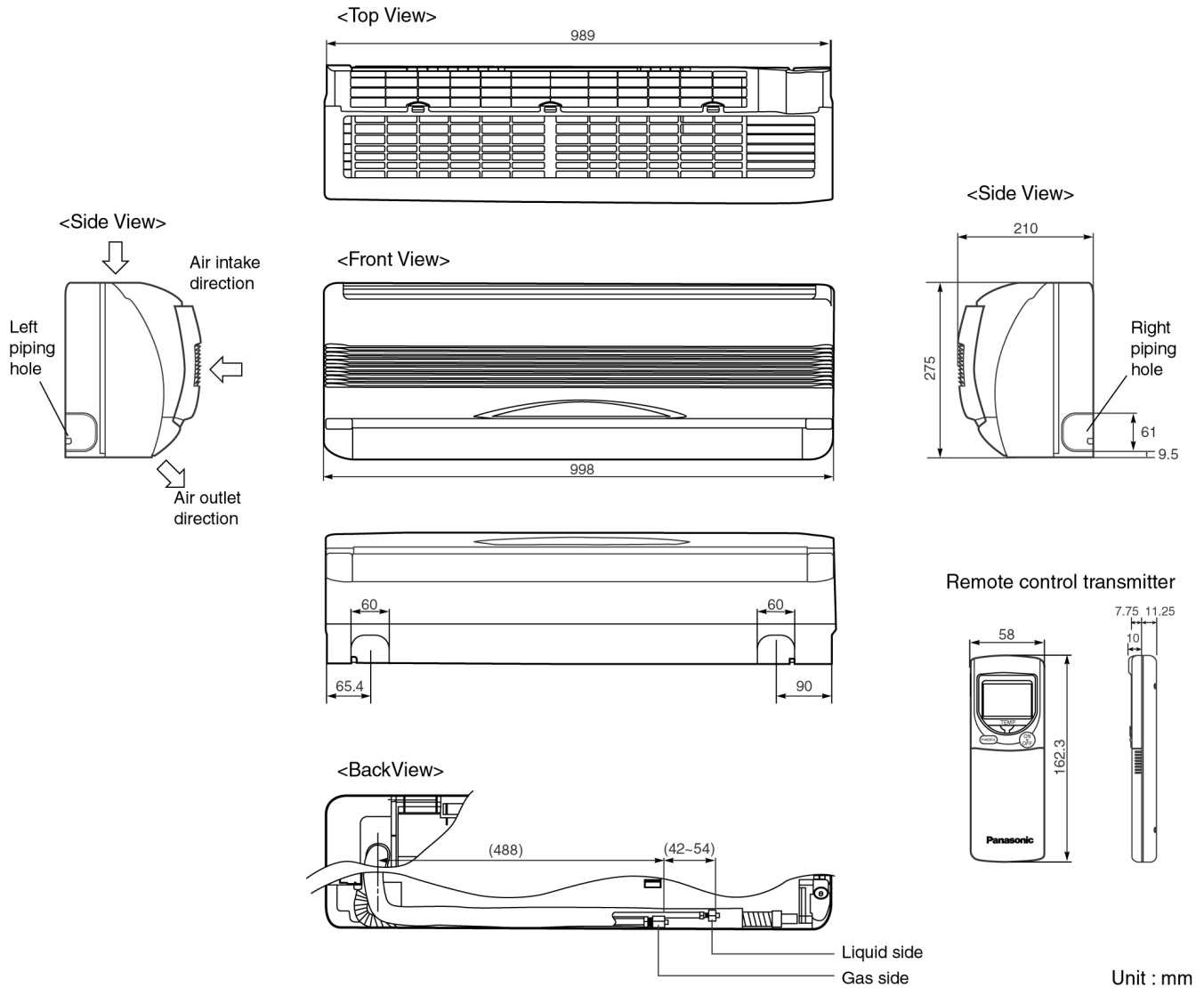

Relative position between the indoor unit and the installation plate <Front View>

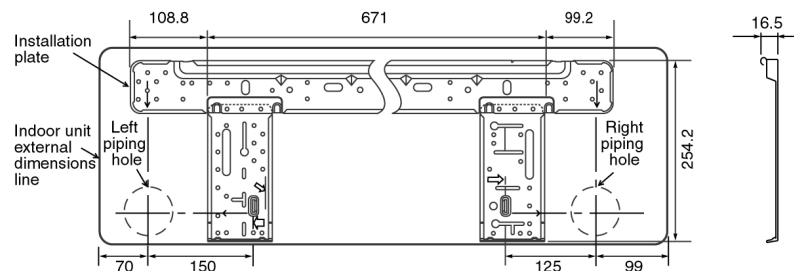

CU-W18CK / CU-W24CK

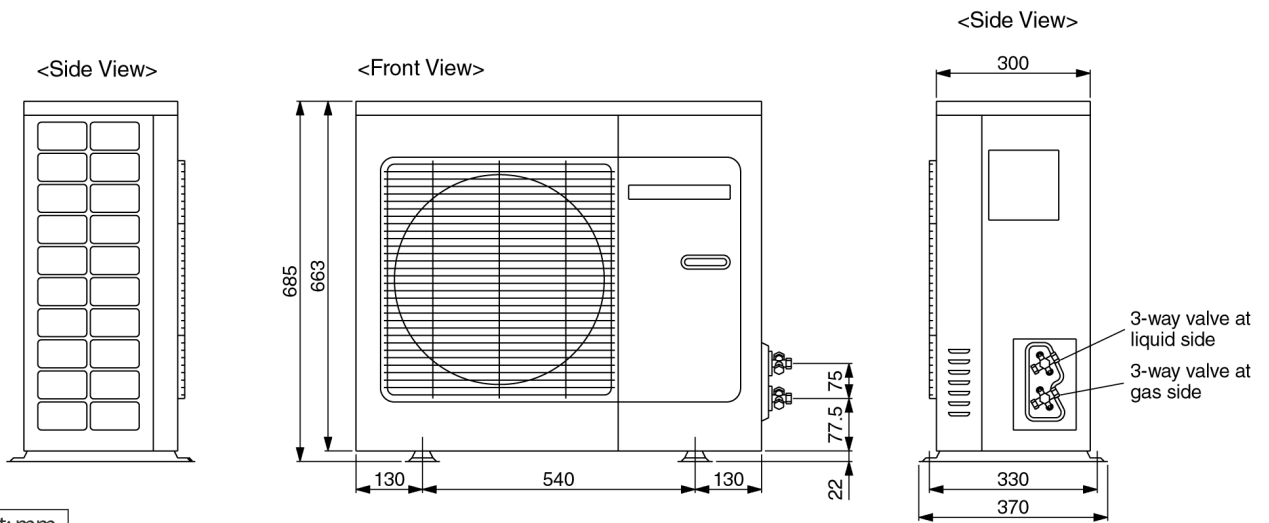
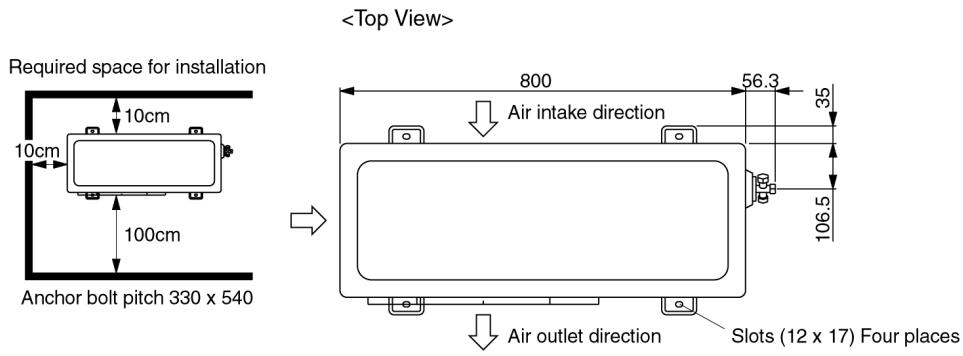

Unit: mm

5 Refrigeration Cycle Diagram

CS-W18CK / CU-W18CK
 CS-W24CK / CU-W24CK

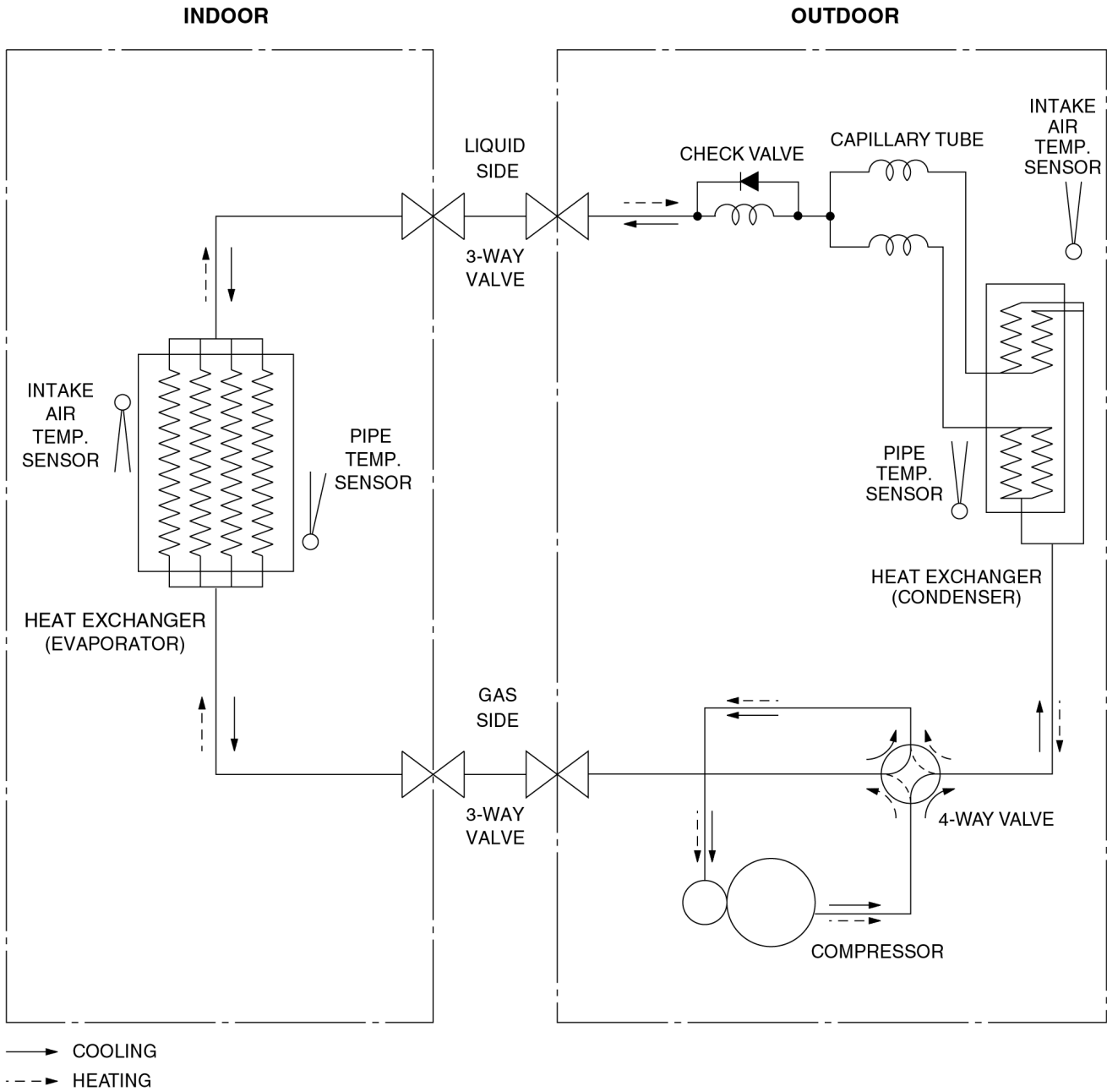

6 Block Diagram

CS-W18CK / CU-W18CK
CS-W24CK / CU-W24CK

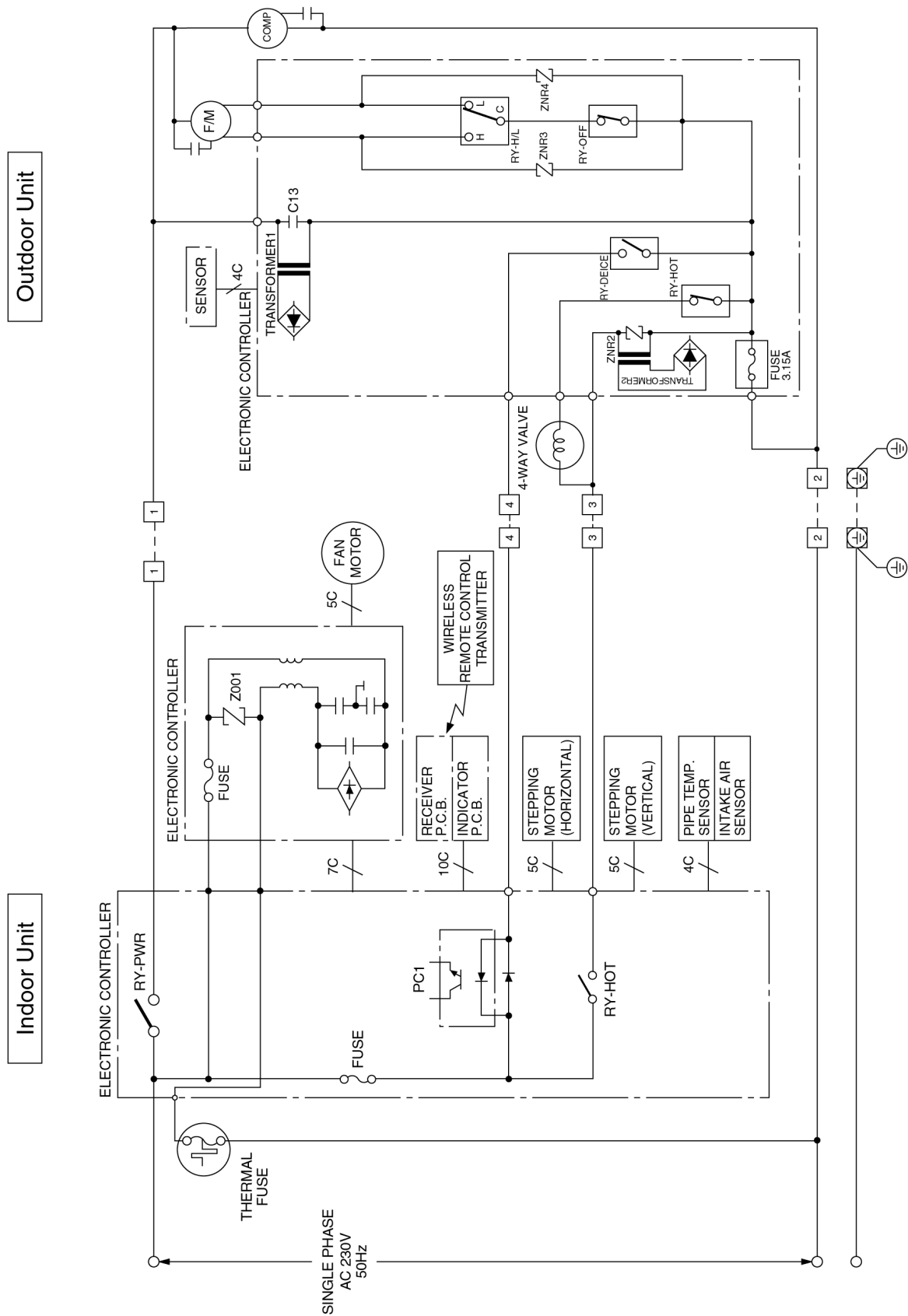

⊗ [] Indicates the electronic control unit.
⊗ 6C Indicates the number of core wires. (Example: 6C=6 core wires)

7 Wiring Diagram

CS-W18CK / CU-W18CK CS-W24CK / CU-W24CK

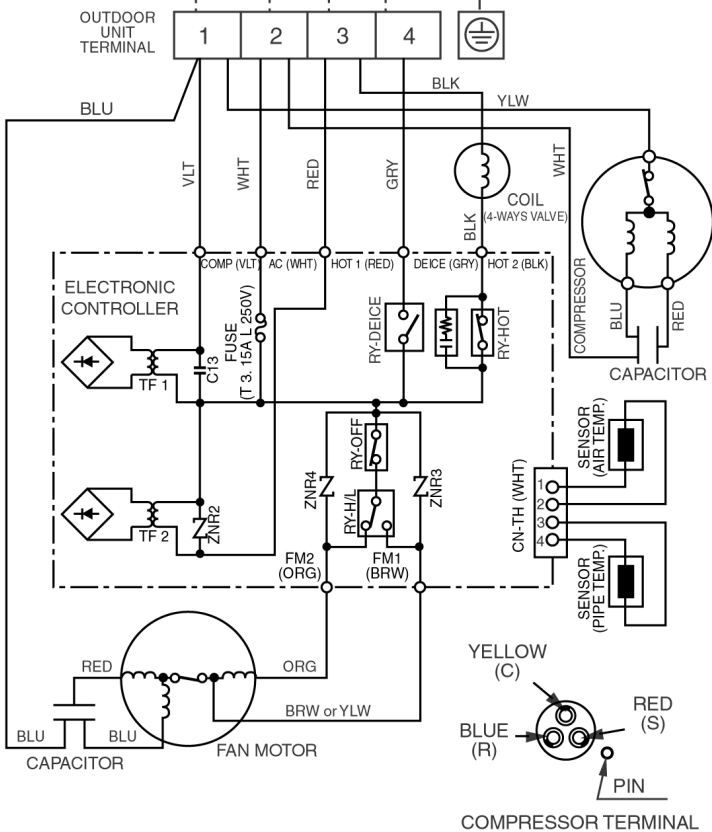
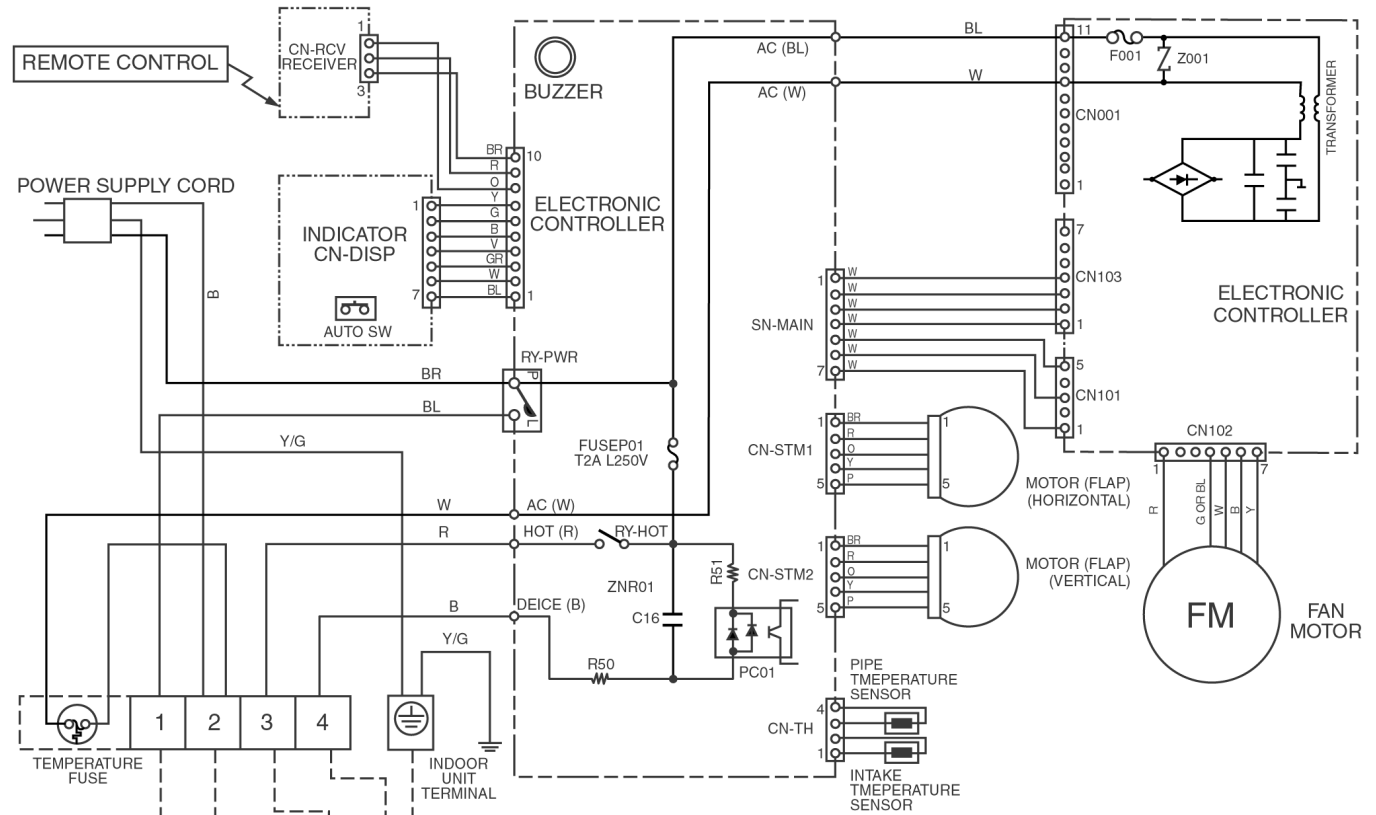

Remarks:

- B : BLUE
- BR : BROWN
- BL : BLACK
- W : WHITE
- R : RED
- O : ORANGE
- P : PINK
- V : VIOLET
- GR : GRAY
- Y/G : YELLOW / GREEN

Resistance of Outdoor Fan Motor Windings

MODEL	CU-W18CK	CU-W24CK
CONNECTION	CWA921182	CWA921081
BLUE - BROWN	97.8 Ω	46.8 Ω
BROWN - ORANGE	77.6 Ω	64.6 Ω
RED - BROWN	82.2 Ω	73.7 Ω

Note: Resistance at 20°C of ambient temperature.

Resistance of Compressor Windings

MODEL	CU-W18CK	CU-W24CK
CONNECTION	5KS205DAA	5JS315DAA
C - R	1.415 Ω	0.803 Ω
C - S	2.407 Ω	2.053 Ω

Note: Resistance at 20°C of ambient temperature.

8 Operation Details

8.1. Cooling Mode Operation

Cooling in operation according to Remote Control setting.

Time Delay Safety Control (3 minutes)

- When the compressor is stopped by Remote Control, it restarts after 3 minutes when the Remote Control is turned ON.
- When the setting temperature is reached during cooling operation, the compressor stops and it will not start for 3 minutes.

7 minutes Time Save Control

- The compressor will start automatically if it has stopped for 7 minutes even if the room temperature is between the compressor ON temperature and OFF temperature.

Anti-Freezing Control

- If the temperature of the indoor heat exchanger falls continuously below 2°C for 4 minutes or more, the compressor turns off to protect the indoor heat exchanger from freezing. The fan speed setting remains the same.
- Compressor will restart again when the indoor heat exchanger temperature rises to 10°C (Recovery).

⊗ 3 minutes waiting of Time Delay Safety Control is valid for Cooling Operation.

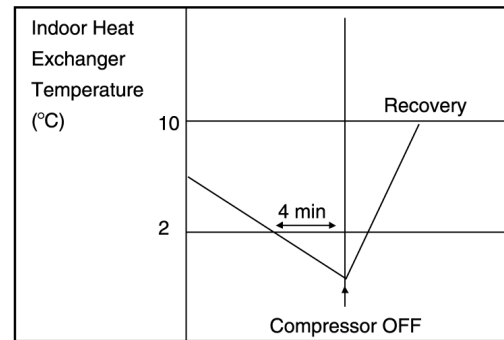

Compressor Reverse Rotation Protection Control

- If the compressor is operating continuously for 5 minutes or longer and the temperature difference between intake air and indoor heat exchanger is 2.5°C or less for 2 minutes, compressor will stop and restart automatically. (Time Delay Safety Control is valid)

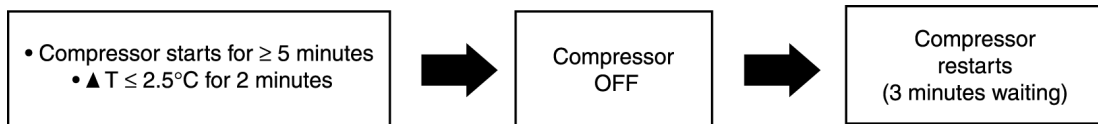

▲ T = Intake air temperature - Indoor heat exchanger temperature

This is to protect reverse rotation of the compressor when there is a instantaneous power failure.

Anti-Dew Formation Control

- Purpose is to prevent dew formation on indoor unit air discharge area.
- When the following conditions occur for 30 minutes continuously, anti-dew formation is controlled by indoor fan speed shift to low (Changed to Lo⁺):
 - Indoor intake air temperature is more than 24°C and less than 30°C.
 - Remote Control setting temperature is less than 25°C.
 - Compressor is on.
 - Cooling operation mode.
 - Indoor Fan motor operate at Low fan speed.
- This control is cancelled immediately when above condition is changed.

Automatic Fan Speed Mode

When Automatic Fan Speed is selected at Remote Control during cooling operation.

- Fan speed rotates in the range of Hi to Me.
- Deodorizing Control.

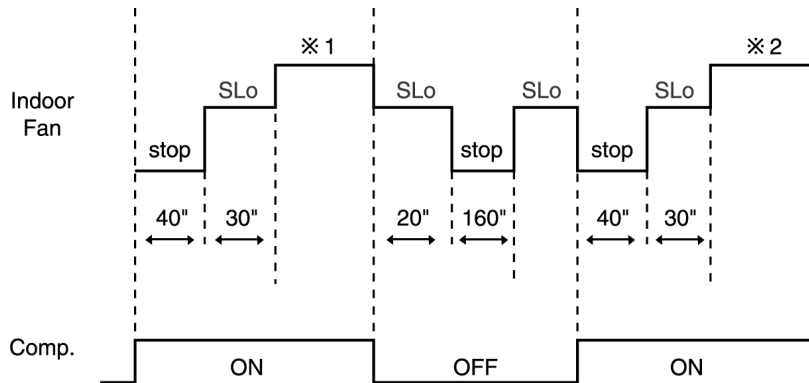

- ※ 1 Fan Speed is Hi until the compressor stops (when the room temperature reaches setting temperature).
- ※ 2 Fan Speed is Me after the compressor restarts.

Cooling Operation Time Diagram

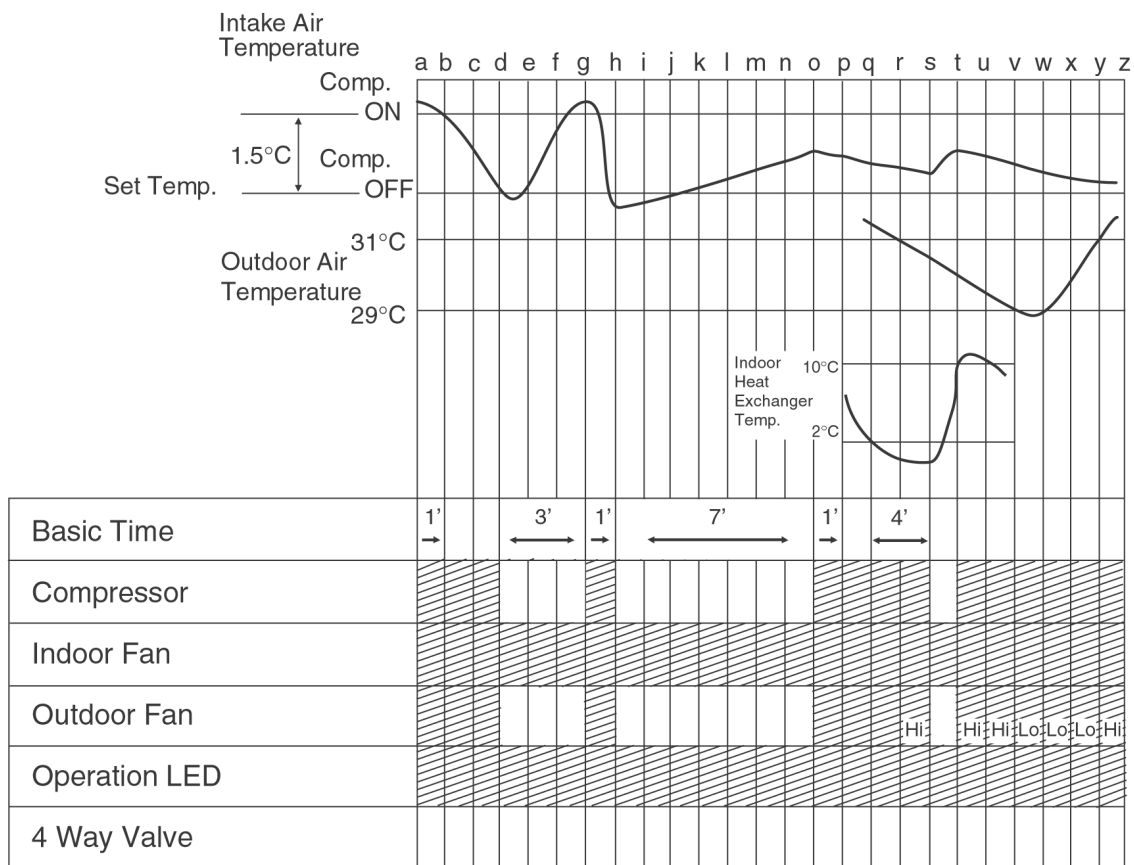

<Description of operation>
 d - g : Time Delay Safety Control (waiting for 3 minutes)
 g - h : 60 sec. Forced Operation
 h - o : 7 min. Time Save Control
 q - t : Anti Freezing Control
 v - y : Outdoor Fan Control



8.2. Soft Dry Mode Operation

- The unit starts cooling operation until the room temperature reaches the setting temperature set on the Remote Control, and then Soft Dry operation will start.
- During Soft Dry operation, the Indoor Fan will operate at SLo speed.
- Once room temperature reaches below Soft Dry OFF temperature. Indoor Fan, Compressor and Outdoor Fan stop for 6 minutes.

Time Delay Safety Control

- Once the compressor stops, it will not start for 3 minutes during Cooling operation.

Anti-Freezing Control

- Same as Anti-Freezing Control for Cooling Mode operation. (For Soft Dry region, 6 minutes waiting is valid during compressor stops.)

Compressor Reverse Rotation Protection Control

- Same as Compressor Reverse Rotation Protection Control for Cooling Mode Operation. (For Soft Dry region, 6 minutes waiting is valid during compressor stops.)

Anti-Dew Formation Control

- Same as Anti-Dew Formation Control for Cooling Mode operation.

Automatic Fan Speed Mode

When Automatic Fan Speed is selected at Remote Control during Soft Dry operation.

- Fan speed off and on at SLo speed.
- Deodorizing Control.

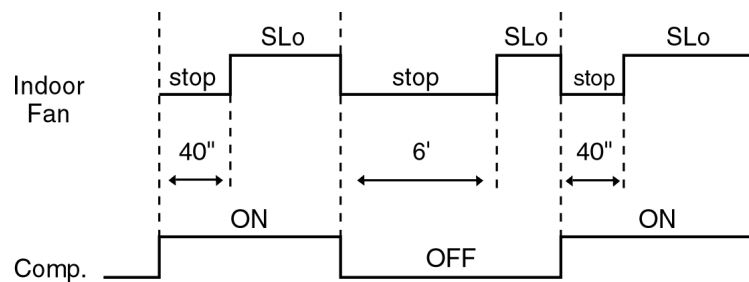

Soft Dry Operation Time Diagram

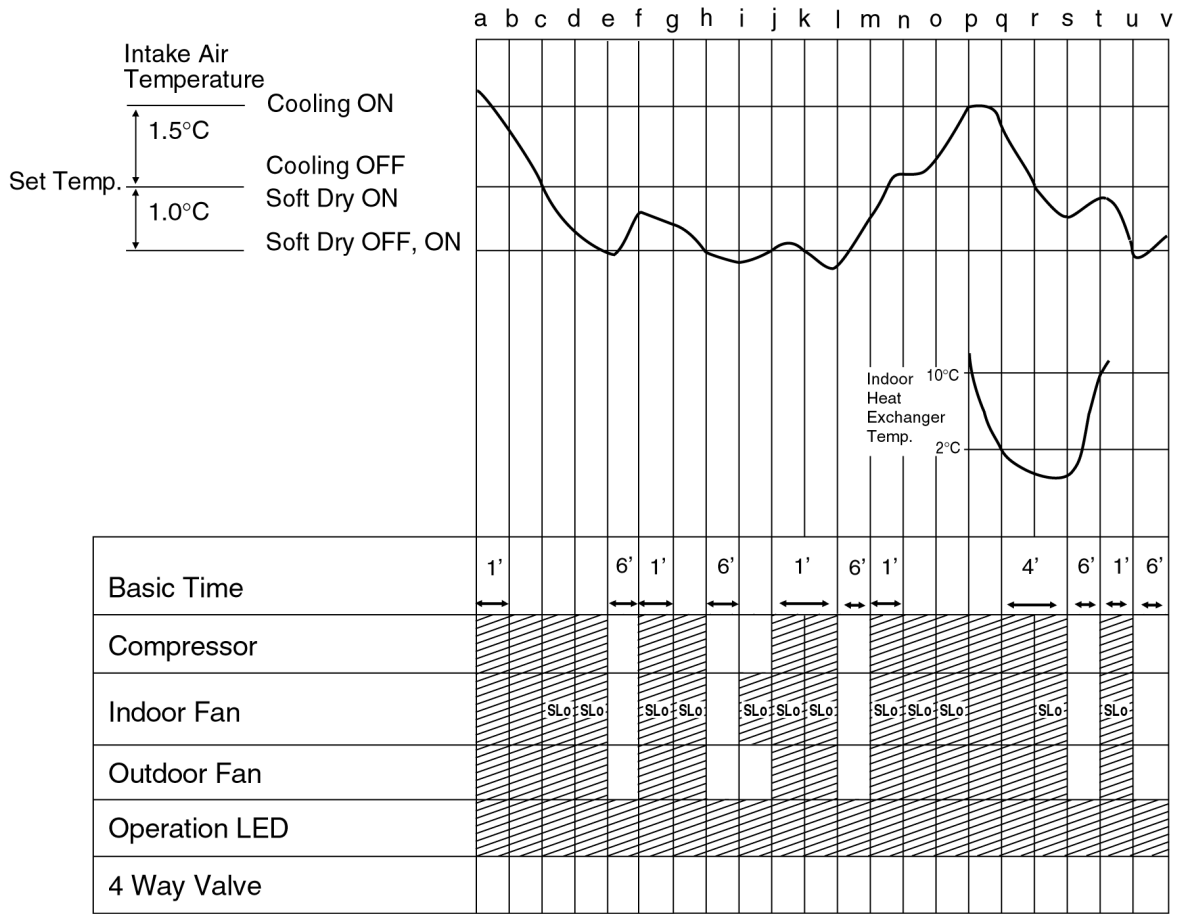

<Description of operation>

- a - c, p - r : Cooling Operation
- c - p : Soft Dry Operation
- e - f : Soft Dry OFF
- j - l : 60 sec. Forced Operation
- q - t : Anti Freezing Control

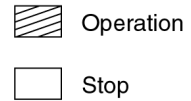

8.3. Heating Mode Operation

- Heating in operation according to Remote Control setting.

Time Delay Safety Control

- When the compressor is stopped by Power Switch, Remote Control or there is a power failure, it restarts after 3 minutes when the Power Switch, Remote Control is turned ON or the power supply is resumed.
- When the setting temperature is reached during heating operation, the compressor stops and it will not start for 4 minutes.

Overload Protection Control

(a) Outdoor Fan Control

- If the temperature of the Outdoor Heat Exchanger less than -3°C, Outdoor Fan is ON. The Outdoor Fan stop, when Outdoor Heat Exchanger temperature is T_b or more according to Outdoor Air Temperature region as table below:
The Outdoor Fan restarts when the indoor heat exchanger temperature falls to 49°C.

Outdoor Air Temperature	<10°C	≥10°C ~ <15°C	≥15°C ~ <20°C	≥20°C ~ <25°C	≥25°C	Outdoor Fan OFF
T_b	≥5°C	≥4°C	≥3°C	≥2°C	≥1°C	

During starting of Heating mode and after deice, Outdoor Fan ON for 90 sec. (Hi).

(b) Compressor High Pressure Control

- If the indoor heat exchanger becomes 68°C or more, the compressor will stop and restart automatically.
(Time Delay Safety Control - 4 minutes waiting).

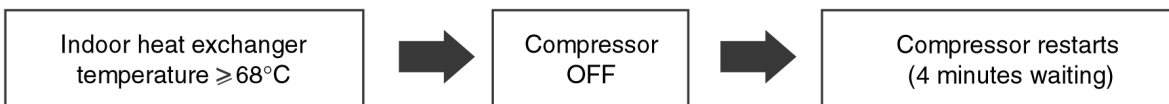

4-way Valve Control

- 4-way valve ON during Heating operation, except deicing operation.
- When the unit is switched to “OFF” during Heating operation, 4-way valve stays at Heating position for 5 minutes.

Hot Start Control

When Heating operation starts, Indoor Fan will not start until the indoor heat exchanger reaches 30°C as diagram shown.

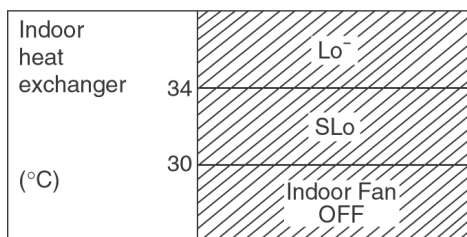

Hot Start is completed when indoor heat exchanger reaches 42°C.

Maximum Hot start duration = 4 minutes. After 4 minutes,

Hot start operation will be shifted to normal Heating operation.

Automatic Fan Speed Mode

When Automatic Fan Speed is selected at Remote Control during heating operation.

- Fan speed rotates in the range of Me → SLo according to the heat exchanger temperature.

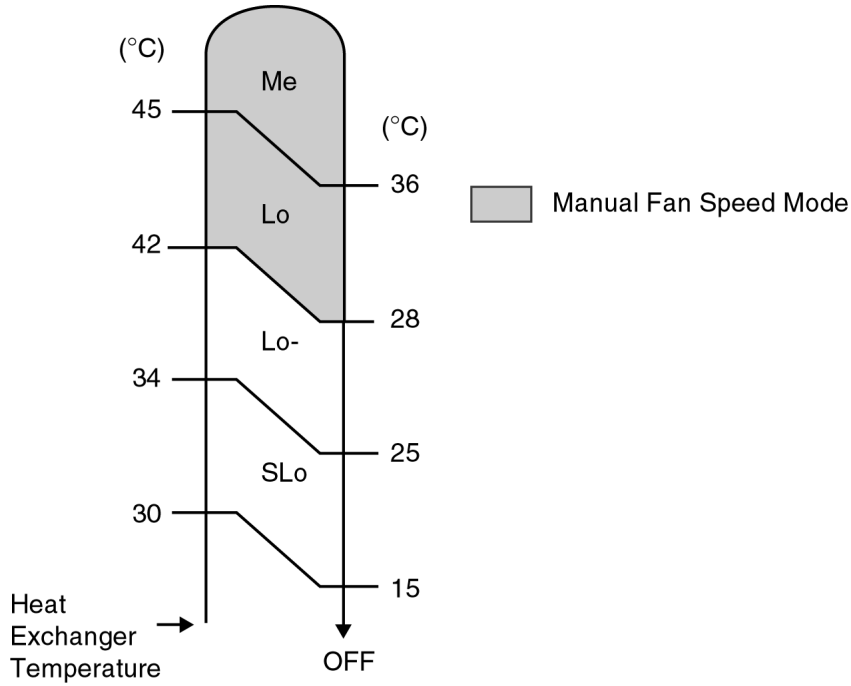

Anti Cold Draft Control

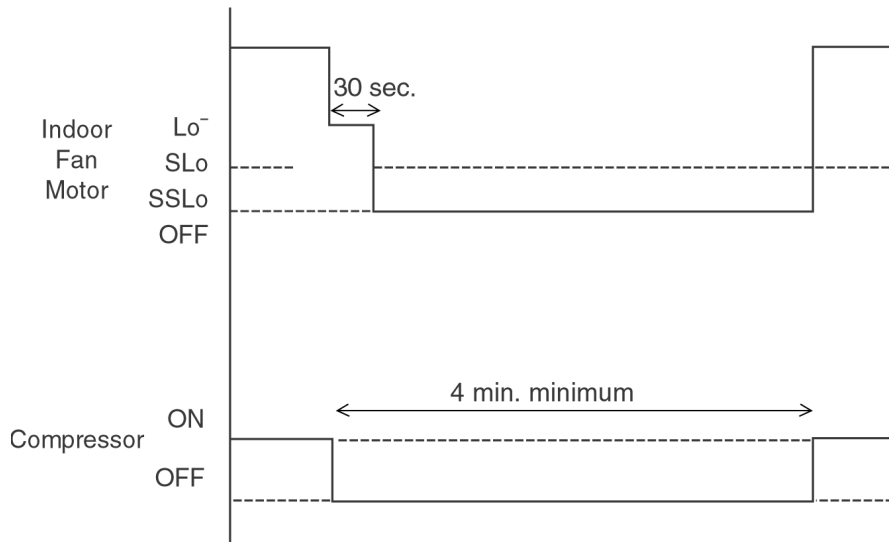

When COMP = Thermal OFF, indoor fan speed immediately changed to Lo⁻ for 30 sec., follow by SSLo speed until COMP = ON.

Heating Operation Time Diagram

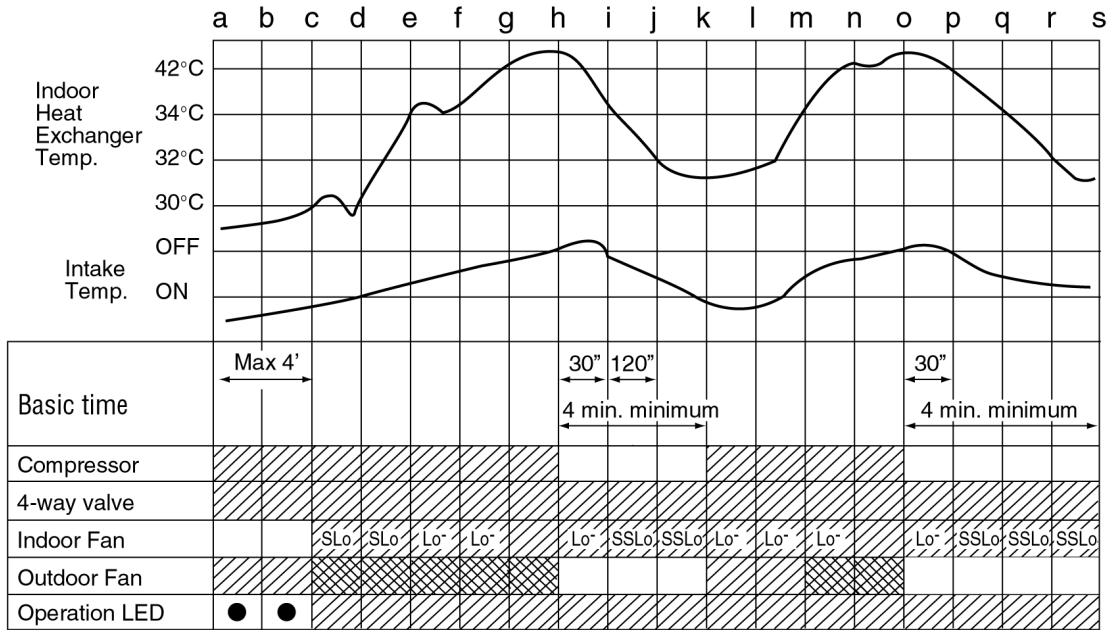

<Description of operation>

- a – c : Hot start (Indoor Fan = OFF)
- c – d : Hot start (Indoor Fan = SLo)
- h – k, o – s : Anti Cold Draft Control

- : Blinking
- ▨ : Operation
- : Stop
- ▩ : Operation or stop

Deicing Control

Deice starts to prevent frosting at outdoor heat exchanger.

• Normal Deicing

Deice operation detection commences in Heating operation starts or 60 minutes after previous deice operation. If the outdoor piping temperature drops to -4°C or 50 sec. continuously during compressor is in operation, deice will start. (There is no detection during Outdoor Fan stops.)

• Overload Deicing

During heating operation, if the outdoor Fan OFF duration (due to overload control) is accumulated up to 60 minutes and after compressor starts for 1 minutes, deicing starts.

• Deicing ends when

- (a) 12 minutes after deicing operation starts;
- (b) The outdoor piping temperature rises to about 12°C.

- After deicing operation, compressor stops for 30 seconds and 4-way valve stays at cooling position for 10 seconds.

a) Normal Deicing Time Diagram

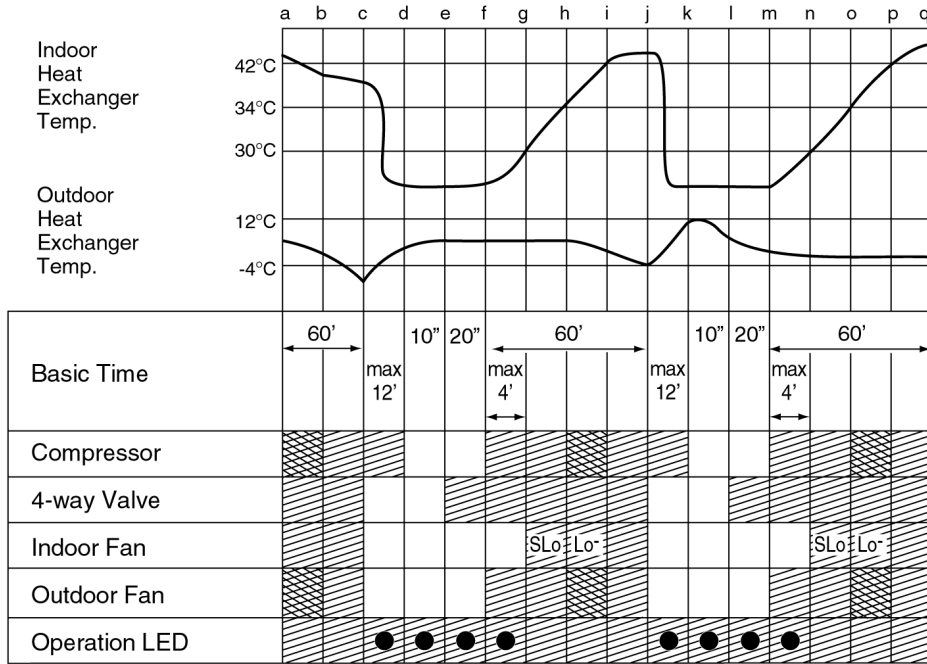

<Description of operation>

- a – c : Deicing operation judging condition established
- c – f : Deicing operation
- f – g : Hot start (add 4 minute delay timing)

- : Blinking
- ▨ : Operation
- : Stop
- ▩ : Operation or stop

(b) Overload Deicing Time Diagram

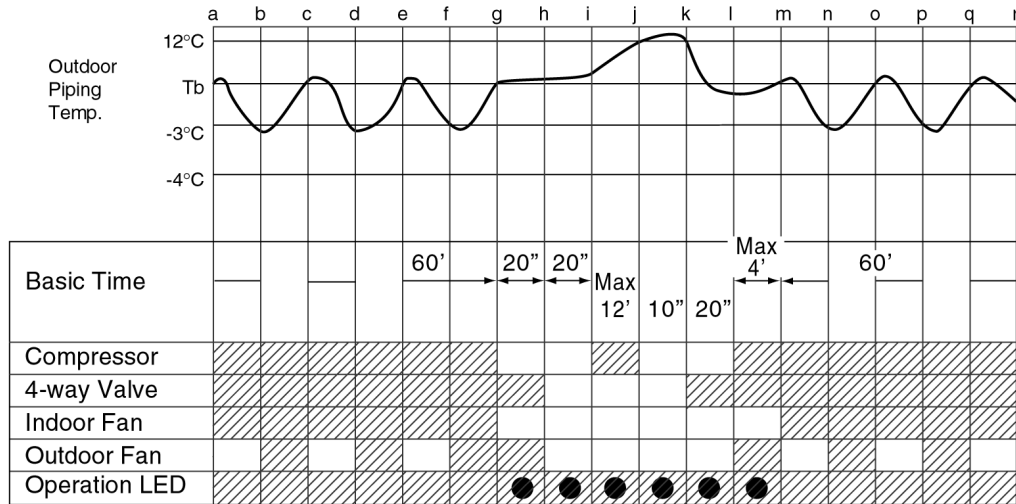

<Description of operation>

- a – i : Overload control
- i – l : Overload deicing
- l – m : Hot start
- m – r : Overload control
- g – i : Preparation for overload deicing (For normal R22 control, operation for g – i is not included, applicable only for new refrigerant model).

- : Blinking
- ▨ : Operation
- : Stop

8.4. Automatic Mode Operation

1. When the Automatic Mode Operation is selected, the indoor fan operates at SLo fan speed for 25 seconds to sense intake air temperature and determine the 1st operation mode. If indoor intake air temperature is less than 16°C, Heating mode will immediate operate.

Standard for Determining Operation Mode 1st Judgement

↑ Intake Air Temperature	23°C	Cooling Mode
	20°C	Soft Dry Mode
		Heating Mode

Operation Mode	Setting Temperature (Standard)
Cooling	25°C
Soft Dry	22°C
Heating	21°C

2. Operation mode will be determine again after 1 hour of operation, if the room temperature reaches to set temperature and compressor off time is over 7 minutes 30 seconds continuously.

- ✘ The present operation mode will be continued, if the room temperature does not reach to set temperature (Compressor keeps running) even though after 1 hour from automatic operation mode started.

Standard for Determining Operation Mode 2nd Judgement onwards

Present Mode	Judgement	Next Mode		
		Cooling	Soft Dry	Heating
Cooling	23°C Cooling Heating	○ (Judgement: 23°C & Above)	Not Applicable	○ (Judgement: Below 23°C)
Soft Dry	23°C Soft Dry Heating	Not Applicable	○ (Judgement: 23°C & Above)	○ (Judgement: Below 23°C)
Heating	23°C Cooling Heating	○ (Judgement: Above 23°C)	Not Applicable	○ (Judgement: 23°C & below)

- ✘ Automatic Set Temperature
Refer 3. as below.

3. Automatic Set Temperature

For each operation, set temperature will automatically set as shown below.

However it can be selected 2°C higher or 2°C lower from standard set temperature by pressing the “Room Temperature Setting button”.

Operation	Hi	(Standard)	Lo
	(+2°C)	(±0°C)	(-2°C)
Cooling	27°C	25°C	23°C
Soft Dry	24°C	22°C	20°C
Heating	23°C	21°C	19°C

- The mode judging temperature and standard setting temperature can be increased by 2°C, by open the circuit of JX1 at indoor electronic controller.

↑ Intake Air Temperature	25°C	Cooling Mode
	22°C	Soft Dry Mode
		Heating Mode

	Setting Temperature (Standard)
Cooling Mode	27°C
Soft Dry Mode	24°C
Heating Mode	23°C

8.5. Sleep Mode Auto Operation

Cooling or Soft Dry Operation

Purpose is to obtain a comfortable room temperature while sleeping. When you press the SLEEP Mode, the following movement will start to avoid overcooling.

- Sleep shift operation starts, when the room temperature reaches the setting temperature or after 1 hour of operation.
- The setting temperature will be risen by **0.5°C** at the start of operation and by **0.5°C** one hour later .
- The airflow volume will automatically change to Lo fan speed.
- Sleep Mode operation time is **8** hours, the operation will be stop after **8** hour.
- When used together with the Timer, the Timer has priority.

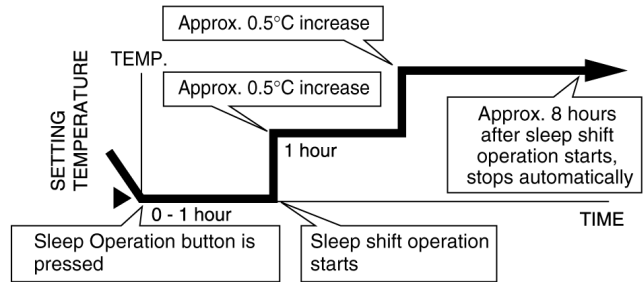

Heating Operation

Purpose is to obtain a comfortable room temperature while sleeping. When you press the SLEEP Mode, the following movement will start to avoid overheating.

- Sleep shift operation starts, when the room temperature reaches the setting temperature or after 1 hour of operation.
- The setting temperature will be decrease by **2°C** at the start of operation and by **3°C** one hour later.
- The fan speed refer to Indoor Fan Motor Control.
- Sleep Mode operation time is **8** hours, the operation will be stop after **8** hour.
- When used together with the Timer, the Timer has priority.

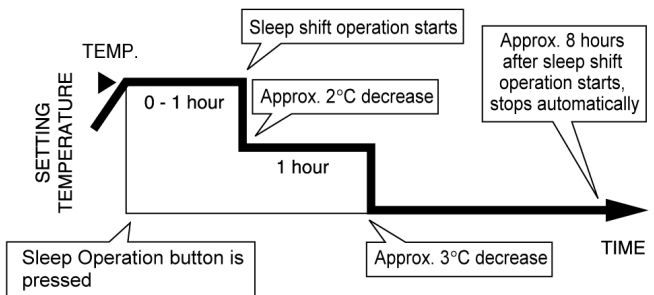

8.6. Random Auto Restart Control

- If there is a power failure, operation will be automatically restarted after 3 to 4 minutes when the power is resumed. It will start with previous operation mode and airflow direction.
- Restart time is decided randomly using 4 parameter:- Intake air temperature, setting temperature, fan speed and Air Swing Blade position.
- Auto Restart Control is not available when Timer or Sleep Mode is set.
- This control can be omitted by open the circuit of JX2. (Refer Circuit Diagram)

8.7. Indoor Fan Speed Control

- Auto Fan Speed Control

When set to Auto Fan Speed, the fan speed is adjusted between maximum and minimum setting as shown in the table.

- Manual Fan Speed Control

Basic fan speed adjustment (3 settings, from Lo to Hi) can be carried out by using the Fan Speed selection button at the remote control.

		Tap	SHi	Hi	Me	Lo+	Lo	Lo-	SLo	SSLo	Stop	
Cooling	Normal	Airflow volume Manual	Hi	○								
			Me		○							
			Lo				○					
		Airflow volume Auto			○	○				○		○
		Sleep Shift								○		
		Powerful	Airflow volume Manual		○							
	Airflow volume Auto		○									
	Sleep Shift								○			
	Economy	Airflow volume Manual								○		
		Airflow volume Auto								○		
		Sleep Shift								○		
	Soft Dry	Normal, Powerful, Economy	Airflow volume Manual							○		○
Airflow volume Auto								○		○		
Sleep Shift								○				
Heating	Normal	Airflow volume Manual	Hi	○				○	○	○	○	
			Me		○			○	○	○	○	
			Lo			○		○	○	○	○	
		Airflow volume Auto				○	○		○	○	○	○
		Sleep Shift							○	○	○	○
		Powerful	Airflow volume Manual		○		○	○		○	○	○
	Airflow volume Auto				○	○		○	○	○	○	
	Sleep Shift							○	○	○	○	
	Economy	Airflow volume Manual		○		○	○		○	○	○	○
		Airflow volume Auto				○	○		○	○	○	○
		Sleep Shift							○	○	○	○

8.8. Airflow Direction Control

Vertical Airflow Direction Auto-Control

- When set a Airflow Direction Auto-Control with remote control, the louver swings up and down as shown in the diagram.
- The louver does not swing when the Indoor Fan Motor stops during operation at the upper limit.
- When stopped with remote control, the discharge vent is reset, and stopped at the closing position.
- During Anti-dew condensation prevention, Airflow Direction Auto-control angle change from 0° - 36° to 12° - 28° under Cooling and Soft Dry operation mode.

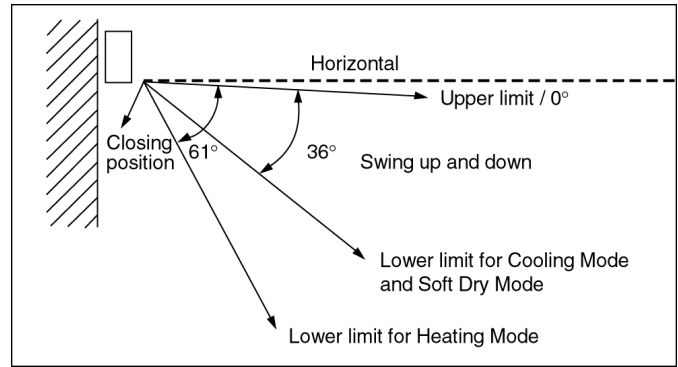

- ⊗ 1. There is no swinging while indoor fan motor is stopped during Cooling and Soft Dry operation.
- ⊗ 2. When the intake air temperature reaches 38°C, the louver is changed from upper to lower limit. When the intake air temperature falls to 35°C, the louver is changed from lower to upper limit.

Vertical Airflow Direction manual Control

- When the manual Airflow Direction Selection Button is pressed, the automatic airflow is released and the airflow direction louver move up and down in the range shown in the diagram.

The louver can be adjusted by pressing the button to the desired louver position.

- When the remote control is used to stop the operation, the discharge vent is reset, and stopped at the closing position.
- During Anti-dew condensation prevention, Airflow Direction Manual control angle change from 14°, 19°, 24°, 30°, 36° to 16°, 18°, 20°, 22°, 24° under Cooling and Soft Dry operation mode.

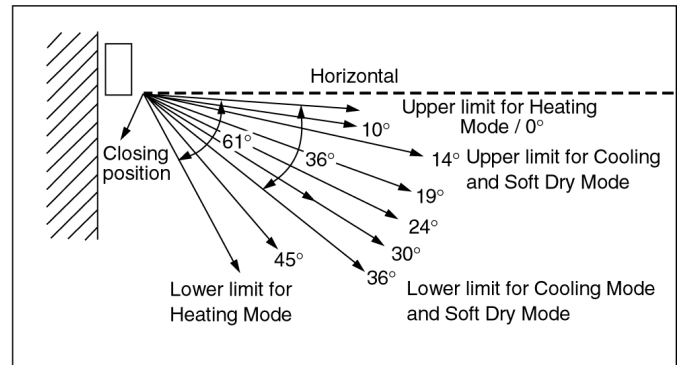

Horizontal Airflow Direction Auto-Control

- When set a Airflow Direction Auto-Control with remote control, the vanes swings left and right as shown in the diagram.
- The vanes does not swing when the Indoor Fan Motor stops during operation at 22° angle.
- When stopped with remote control, the discharge vent is reset, and stopped at the reset position.
- During Anti-dew condensation prevention, Airflow Direction Auto-control angle change from 0° - 44° to 14° - 30° under Cooling and Soft Dry operation mode.

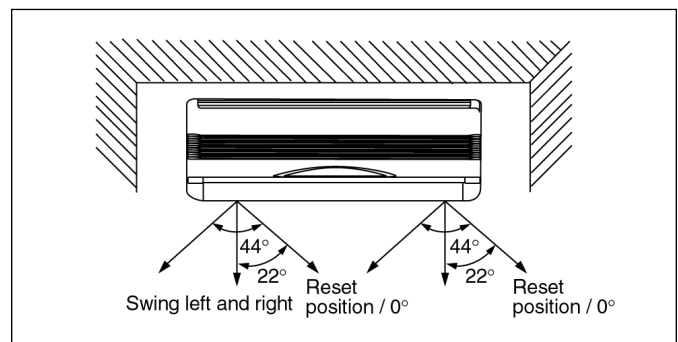

- ⊗ 1. There is no swinging while indoor fan motor is stopped during Cooling and Soft Dry operation.
- ⊗ 2. In Heating operation, when the intake air temperature reaches set temperature, the airflow direction is Auto Swing left and right. When the intake air temperature falls to 2°C lower than set temperature, the airflow direction is stop at 22° angle.

Horizontal Airflow Direction manual Control

- When the manual Airflow Direction Selection Button is pressed, the automatic airflow is released and the airflow direction vane move left and right in the range shown in the diagram.

The louver can be adjusted by pressing the button to the desired vane position.

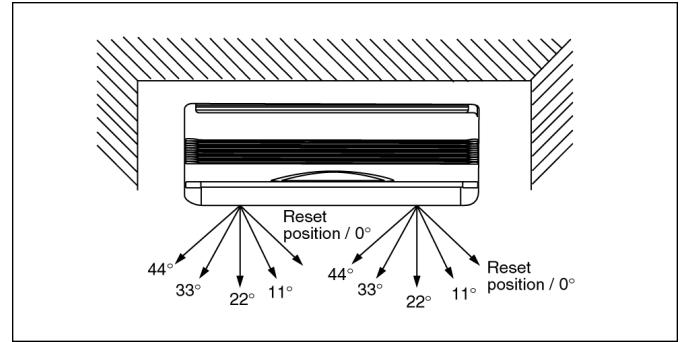
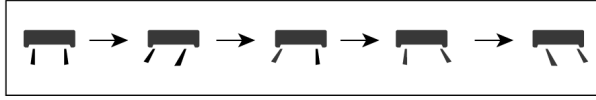

- When the remote control is used to stop the operation, the vanes is reset, and stopped at reset position.
- During Anti-dew condensation prevention, Airflow Direction Manual control angle change from 0°, 11°, 22°, 33°, 44° to 14°, 18°, 22°, 26°, 30° under Cooling and Soft Dry operation mode.

8.9. Delay ON Timer Control

- When the Delayed ON Timer is set by using the remote control, the unit will start operate slightly before the set time, so that the room will reach nearly to the set temperature by the desired time.
- For Cooling and Soft Dry mode, the operation will start 15 minutes before the set time.
- For Heating mode, the operation will start 30 minutes before the set time.
- For Automatic mode, the indoor fan will operate at SLo speed for 25 seconds, 30 minutes before the set time to detect the intake air temperature to determine the operation mode. The operation indication lamp will blink at this time.

8.10. Remote Control Signal Receiving Sound

- Long beep sound will be heard when:-
 - Stopping the Air Conditioner using ON/OFF switch.
 - Stopping the Sleep Mode.
 - Stopping the Powerful Mode.
 - Stopping the Economy Mode.
- Short beep sound will be heard for others.
- To switch off the beep sound:-

Press the “Automatic Operation Button” continuously for 10 seconds or more (“beep” “beep” will be heard at the 10th second). Repeat the above if you want to switch ON the beep sound.

⊗ However, if the “Automatic Operation Button” has been pressed the Automatic operation will be activated. If you do not require this operation, you may change it by using the remote control.

8.11. Economy Mode Operation

Purpose of this operation is to save or reduced electrical power consumption of the room air conditioner.

However consumer is advised to use Economy Mode operation after the room temperature reaches the desired temperature.

1. Cooling and Soft Dry Mode

- When the Economy Mode is set, the set temperature will be automatically increased 0.5°C against the present setting temperature. This operation automatically will be running under SLo Fan speed.
- Vertical Airflow Direction:-
In "Manual" or "Auto" setting, the vane will automatically change to Auto Air Swing.

2. Heating Mode

- When the Economy Mode is set, the temperature will be automatically decreased 0.5°C against the present setting temperature.
- The Fan Speed will shift as shown below:

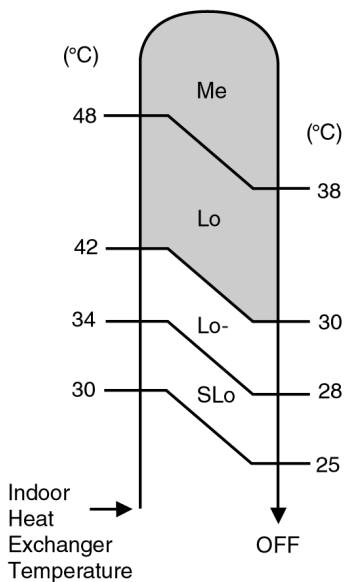

- When the Auto Fan speed is selected, the fan speed will automatically change from Lo to Me depending to the Indoor piping temperature.
- When the manual Fan Speed is selected, the fan speed will automatically change to Lo, then follows set fan speed when the Indoor piping temperature reaches 42°C.

 Set Fan Speed

- Vertical Airflow Direction:-
In "Manual" or "Auto" setting, the vane will automatically change to Auto Air Swing.

3. Economy Mode will stop if:

- Economy mode button is pressed again.
- Stopped by ON / OFF switch.
- Timer-off activates.
- Powerful mode button is pressed.
- Fan Speed control button is pressed.
- Sleep mode button is pressed ON.
- Operating mode is changed.
- Air Swing condition is changed.

8.12. Powerful Mode Operation

Purpose of this operation is to be obtain the setting temperature quickly.

1. Cooling and Soft Dry Mode

- When the Powerful Mode is set, the set temperature will be automatically decreased 3°C against the present setting temperature. This operation automatically will be running under SHi Fan Speed (Cooling), SLo Fan Speed (Soft Dry).
- Vertical Airflow Direction:-
In “Manual” setting, the vane will automatically shift down 10°C lower than previous setting.
In “Auto” setting, the vane will automatically swing up and down. However the upper and lower limit will be shifted 10° downward.

2. Heating Mode

- When the Powerful Mode is set, the set temperature will be automatically increased 3°C against the present setting temperature.
- The Fan Speed will shift as shown below:

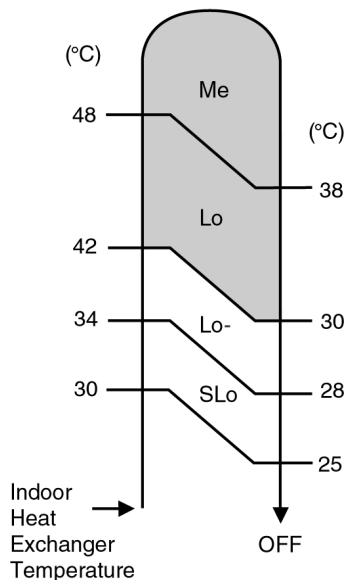

- When the Auto Fan speed is selected, the fan speed will automatically change from Lo to Me depending to the Indoor piping temperature.
- When the manual Fan Speed is selected, the fan speed will automatically set to Lo, then follows set fan speed when the Indoor piping temperature reaches 42°C.

■ Set Fan Speed

- Vertical Airflow Direction:-
In “Manual” setting, the vane will automatically shift down 5°C lower than previous setting.
In “Auto” setting, the vane will automatically shift between upper and lower limit depending on the intake air temperature as Heating Mode, Airflow Direction Auto-Control. However the upper and lower limit will be shifted 5°C downward.

3. Powerful mode will operate for 15 minutes only.

4. Powerful Mode will stop if:

- Powerful mode button is pressed again.
- Stopped by ON / OFF switch.
- Timer-off activates.
- Economy mode button is pressed.
- Sleep mode button is pressed.
- Operating mode is changed.

9 Operating Instructions

SAFETY PRECAUTIONS

Before operating, please read the following "Safety Precautions" carefully.

- To prevent personal injury, injury to others and property damage, the following instructions must be followed.
- Incorrect operation due to failure to follow instructions will cause harm or damage, the seriousness of which is classified as follow:



This sign warns of death or serious injury.



This sign warns of damage to property.

- The instructions to be followed are classified by the following symbols:



This symbol (with a white background) denotes an action that is PROHIBITED.



These symbols (with a black background) denote actions that are COMPULSORY.

Installation Precautions



- Do not install, remove and reinstall the unit by yourself.** Improper installation will cause leakage, electric shock or fire. Please engage an authorized dealer or specialist for the installation work.



- This room air conditioner must be earthed.** Improper grounding could cause electric shock.
- Ensure that the drainage piping is connected properly.** Otherwise, water will leak out.
- Do not install the unit in a potentially explosive atmosphere.** Gas leak near the unit could cause fire.

Operation Precautions



This sign warns of death or serious injury.



- Do not share outlet.
- Do not insert plug to operate the unit. Do not pull out plug to stop the unit.
- Do not operate with wet hands.
- Do not damage or modify the power cord.
- Do not insert finger or other objects into the indoor or outdoor units.
- Do not expose directly to cold air for a long period.



- Plug in properly.
- Use specified power cord.



- If abnormal condition (burnt smell, etc.) occurs, switch off and unplug the power supply.



This sign warns of injury.



- Do not pull the cord to disconnect the plug.
- Do not wash the unit with water.
- Do not use for other purposes such as preservation.
- Do not use any combustible equipment at airflow direction.
- Do not sit or place anything on the outdoor unit.



- Switch off the power supply before cleaning.
- Ventilate the room regularly.
- Pay attention as to whether the installation rack is damaged after long period of usage.



- Switch off the power supply if the unit is not used for a long period.

NAME OF EACH PART

Indoor Unit

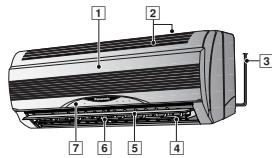

- Front Panel
- Air Intake Vent
- Power Supply Cord
- Air Outlet Vent
- Vertical Airflow Direction Louver
- Horizontal Airflow Direction Louver
- Indicator Panel

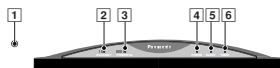

- Auto Operation Button (when the front panel is opened)
- Economy Mode Indicator - GREEN
- Powerful Mode Indicator - ORANGE
- Power Indicator - GREEN
- Sleep Mode Indicator - ORANGE
- Timer Mode Indicator - ORANGE

Indoor Unit (when the front panel is opened)

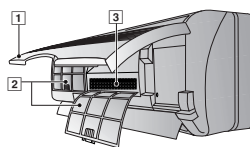

- Front Panel
- Air Filters
- Air Purifying Filter

Outdoor Unit

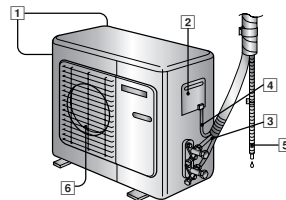

- Air Intake Vents
- Ground Terminal (inside cover)
- Piping
- Connecting Cable
- Drain Hose
- Air Outlet Vents

Accessories

Remote Control



Remote Control Indication Sticker

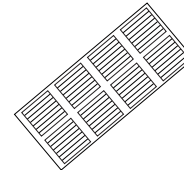

Remote Control Holder



Two RO3 (AAA) dry-cell batteries or equivalent



Air Purifying Filter

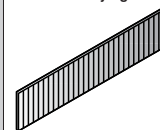

(Catechin Air Purifying Filter)

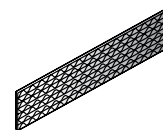

(Solar Refreshing Deodorizing Filter)

NAME OF EACH PART

Remote Control

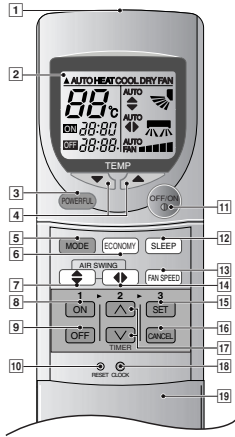

- **Remote Control Signal.**
 - Make sure it is not obstructed.
 - Maximum distance : 10 m.
 - Signal received sound.
 - One short beep or one long beep.
- **Notes for Remote Control.**
 - Do not throw or drop.
 - Do not get it wet.
 - Certain type of fluorescent lamps may affect signal reception. Consult your dealer.

- Signal Transmitter
- Operation Display
- Powerful Mode Operation Button
- Room Temperature Setting Button (self-illuminating button)
- Operation Mode Selection Button
- Economy Mode Operation Button
- Vertical Airflow Direction Button
- ON-Timer Button
- OFF-Timer Button
- Reset Point (Press with fine-tipped object to clear the memory)
- OFF/ON Button (self-illuminating button)
- Sleep Mode Operation Button
- Fan Speed Selection Button
- Horizontal Airflow Direction Button
- Timer Set Button
- Timer Cancellation Button
- Time-Setting Button
- Clock Button
- Remote Control Cover

How to Insert the Batteries

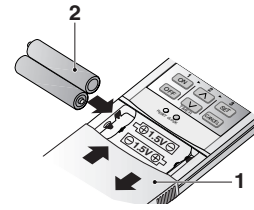

1 Slide down the remote control cover completely

2 Insert the batteries

- Be sure the direction is correct
- 12.00 at display - flashing
- Set the current time (CLOCK) immediately to prevent battery exhaustion.

About the batteries

- Can be used for approximately one year.

Observe the following when replacing the batteries

- Replace with new batteries of the same type.
- Do not use rechargeable batteries (Ni-Cd).
- Remove the batteries if the unit is not going to be used for a long period.

PREPARATION BEFORE OPERATION

Indoor Unit

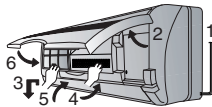

- Connect the power supply cord to an independent power supply
- Open the front panel
- Remove the air filters
- Fit the air purifying filters in place
- Insert the air filters
- Close the front panel

Remote Control

- To set the current time

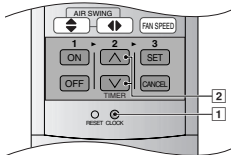

- Press [1].
- Then press [2] to increase or decrease the time.
- Press [1] again.
Set time at display will light up.

HOW TO OPERATE

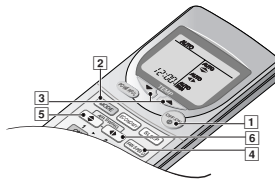

- **To start the operation**
 - Press [1].
 - POWER indicator (green) on the indoor unit will light up.
 - To stop, press once more.

Setting Mode

- Press [2] to select:-

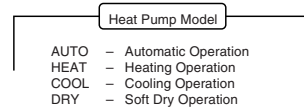
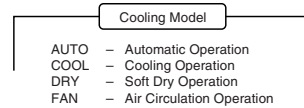

Setting Temperature

- Press [3] to increase or decrease the temperature.
- The temperature can be set between 16°C ~ 30°C.
- Recommended temperature:

Cooling Model		Heat Pump Model	
COOL	- 26°C ~ 28°C	COOL	- 26°C ~ 28°C
DRY	- 1°C ~ 2°C lower than the room temperature	DRY	- 1°C ~ 2°C lower than the room temperature
		HEAT	- 20°C ~ 24°C

• During AUTO Operation, press [3] to select:-

- Operation with 2°C higher than the standard temperature.
- Operation with the standard temperature.
- Operation with 2°C lower than the standard temperature.

Standard Temperature

Indoor temperature	Cooling Model		Standard temperature
	Operation	Standard temperature	
23°C	Cooling	25°C	
	Soft Dry	22°C	

- Once the Automatic Operation is selected, the indoor temperature sensor operates automatically to select the desired operation mode with Cooling or Soft Dry.
- After the operation mode has been selected, the mode does not change.

Indoor temperature	Heat Pump Model		Standard temperature
	Operation	Standard temperature	
23°C	Cooling	25°C	
	Soft Dry	22°C	
	Heating	21°C	

- At the beginning of the automatic operation, Heating, Cooling or Soft Dry is automatically selected according to the indoor temperature.
- The operation mode changes every hour, when necessary.

Setting the Fan Speed

• Press [1] to select:-

- FAN [] - Low Fan Speed
- FAN [] - Medium Fan Speed
- FAN [] - High Fan Speed
- AUTO - Automatic Fan Speed

The speed of the indoor fan is adjusted automatically according to the operation. The indoor fan stops occasionally during cooling operation.

Setting the Vertical Airflow Direction.

• Press [5] to select:-

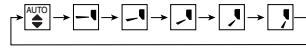

AUTO • For COOL/DRY operation. Swing up/down automatically.

AUTO • For HEAT operation (For Heat Pump Model only) When the discharge air temperature is low such as at the start of the heating operation, the air blows at horizontal level. As the temperature rises, the hot air blows in a downwards direction.

Setting the Horizontal Airflow Direction.

• Press [6] to select:-

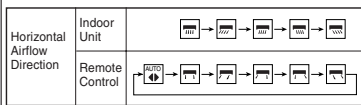

AUTO • For COOL/DRY operation. Swing left/right automatically.

AUTO • For HEAT operation (For Heat Pump Model only) There is no air swing during the discharge air temperature is low. When the temperature rises, the horizontal airflow louvers swing left/right automatically.

Use this air conditioner under the following conditions:

Cooling Model					
(Unit in °C)					
DBT: Dry Bulb Temp WBT: Wet Bulb Temp	Indoor		Outdoor		
	DBT	WBT	DBT	WBT	
Maximum Temperature	32	23	43	26	
Minimum Temperature	16	11	16	11	

Heat Pump Model					
(Unit in °C)					
DBT: Dry Bulb Temp WBT: Wet Bulb Temp	Indoor		Outdoor		
	DBT	WBT	DBT	WBT	
Maximum Temperature-Cooling (Maximum Temperature-Heating)	32 (30)	23 (-)	43 (24)	26 (18)	
Minimum Temperature-Cooling (Minimum Temperature-Heating)	16 (16)	11 (-)	16 (-5)	11 (-6)	

Notes

- If the unit is not going to be used for an extended period of time, turn off the main power supply. If it is left at the ON position, approximately 2.5 W of electricity will be used even if the indoor unit has been turned off with the remote control.
- If operation is stopped, then restart immediately, the unit will resume operation only after 3 minutes.

Operation Details

COOL – Cooling Operation

- To set the room temperature at your preference cooling comfort.

AUTO – Automatic Operation

- Sense indoor temperature to select the optimum mode.
- Temperature is not displayed on the remote control during AUTO operation.

DRY – Soft Dry Operation

- A very gentle Cooling Operation, prior to dehumidification. It does not lower the room temperature.
- During Soft Dry operation, the indoor fan operates at Low fan speed.

HEAT – Heating Operation

(for Heat Pump Model only)

- Heat is obtained from outdoor air to warm up the room. When the outdoor ambient air temperature falls, the heating capacity of the unit might be reduced.
- Defrosting Operation Depend on the outdoor temperature, the operation occasionally stops to melt the frost on the outdoor unit.

FAN – Air Circulation Operation

(for Cooling Model only)

- When the room temperature reaches the set temperature, operation commences at Low airflow volume. It stops when the room temperature drops to 2°C below the set temperature. (It is useful when using a heater).

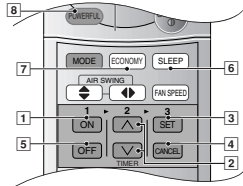

SETTING THE TIMER

Ensure that the current time is correct before setting the timer. The timer cannot be set if the time display is flashing.

ON-TIMER Operation

- To start the air conditioner operation automatically.
- Press [1] to set the operation.
- Press [2] to increase or decrease the time.
- Then press [3].
- To cancel this operation, press [4].

OFF-TIMER Operation

- To stop the air conditioner operation automatically.
- Press [5] to set the operation.
- Press [2] to increase or decrease the time.
- Then press [3].
- To cancel this operation, press [4].

Timer Mode Operation Details

- When the ON-Timer is set, operation will start before the actual set time. This is to enable the room temperature reaches the set temperature at the set time.

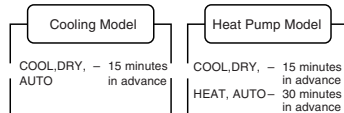

- Once the ON-Timer is set, operation will start at the set time everyday.
- The current time is not displayed when the timers are set.
- When both timers are used together, the TIMER mode indicator on the indoor unit remains lit even when the operation is stopped by the OFF-TIMER.

CONVENIENCE OPERATION

Sleep Mode Operation

- To obtain a comfortable room temperature while sleeping:-
- Press [6].
- Sleep mode indicator on the indoor unit will light up.
- To cancel this operation, press once more.

Sleep Mode Operation Details

- When the room temperature reaches the set temperature, the airflow volume will change to low automatically.
- Sleep Mode Operation time is 8 hours.
- When used together with the timer, the timer has a priority.

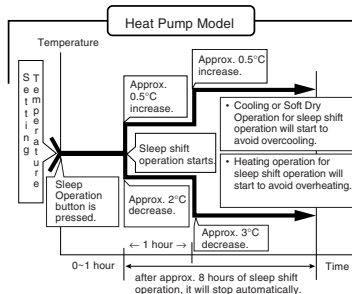
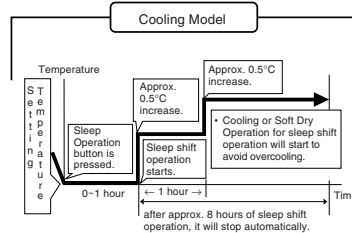

Economy Mode Operation

To save electrical power consumption. Please use this mode when the room has reached your desired temperature.

- Press [7].
- ✗ Economy mode indicator (green) on the indoor unit will light up.
- Press once more to cancel this operation.

Powerful Mode Operation

To obtain the set temperature quickly.

- Press [8].
- ✗ Powerful mode indicator (orange) on the indoor unit will light up.
- ✗ Powerful mode will operate for 15 minutes only.
- To cancel this operation, press once more.

Economy / Powerful Mode Operation Details

- Economy and Powerful operation cannot be selected simultaneously.
- The changes of the temperature and airflow volume are automatic.
- The remote control display remains unchanged.
- If sleep button or operation mode button is pressed, economy or powerful operation will be cancelled.
- During **FAN – Air Circulation operation**, the powerful and economy operation are not available. (cooling model only)

Economy Mode Operation	Temperature	Airflow volume
COOL / DRY	0.5°C higher than set temp.	Super Low
HEAT (for Heat Pump model only)	0.5°C lower than set temp.	Automatic

Powerful Mode Operation	Temperature	Airflow volume
COOL / DRY	3°C lower than set temp.	Super High
HEAT (for Heat Pump model only)	3°C higher than set temp.	Automatic

CARE AND MAINTENANCE

■ Cleaning the Indoor Unit and Remote Control

- Wipe gently with a soft, dry cloth.
- Do not use water hotter than 40°C or polishing fluid to clean the unit.

■ Cleaning the Air Filter

(Recommendation:- If the unit is operated in a dusty environment, clean the filters every two weeks, continuous use of this dirty filters will reduce cooling or heating efficiency)

- 1 Remove dirt using a vacuum cleaner.
 - 2 Wash back of the air filter with water.
 - 3 If badly soiled, wash it with soap or a mild household detergent.
 - 4 Let it dry and reinstall it.
Be sure the "FRONT" mark is facing you.
✗ Damaged air filter.
Consult the nearest authorized dealer.
Part No.: CWD001049.
- Do not use benzene, thinner, scouring powder or clothes soaked in caustic chemical to clean the unit.

■ Cleaning the Front Panel

(Must be removed before washing)

- 1 Raise the front panel higher than the horizontal and pull to remove it.
- 2 Gently wash with water and a sponge.
 - Do not press the front panel too hard when washing.
 - When use kitchen cleaning fluid (neutral detergent), rinse thoroughly.
 - Do not dry the front panel under direct sunlight.
- 3 To fix the front panel, raise the front panel horizontally, match the protruding portion on the indoor unit to the fulcrum and push into place.

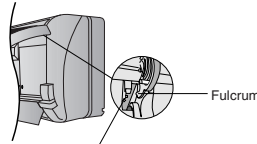

Protruding portion on indoor unit

■ Air Purifying Filters

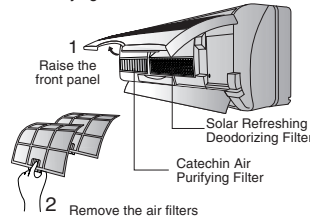

● Solar Refreshing Deodorizing Filter

- Used to remove unpleasant odour and deodorize the air in the room.
- Reusable.
- Vacuum, place under direct sunlight for 6 hours and fit it back in place.
(Recommended : every 6 months)

● Catechin Air Purifying Filter

- The filter is coated with catechin to prevent growth of bacteria and viruses.
- Reusable.
- Vacuum and fit it back in place
(Recommended : every 6 months)

- Recommended to change these filters every 3 years. Do not reuse damaged filters. Consult the nearest authorized dealer to purchase a new filter.

Catechin Air Purifying Filter No.: CZ-SF70P
Solar Refreshing Deodorizing Filter No.: CZ-SFD70P

- If you operate the air conditioner with dirty filters:-
– Air is not purified
– Cooling capacity decreases
– Foul odour is emitted

■ Pre-season Inspection

● Is the discharged air cold/warm?

Operation is normal if 15 minutes after the start of operation, the difference between the air intake and outlet vents temperature is:-

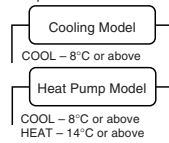

● Are the air intake or outlet vents of the indoor or outdoor units obstructed?

● Are the remote control batteries weak?

If the remote control display appears weak, replace the batteries.

■ When the Air Conditioner is Not Used for an Extended Period of Time

- 1 To dry the internal parts of the indoor unit, operate the unit for 2 - 3 hours using:-

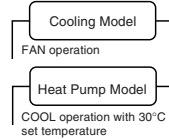

- 2 Turn off the power supply and unplug.

Note: If the unit is not switched off by the remote control, it will start operating when you plug in (because the unit is equipped with Auto Restart Control).

- 3 Remove the remote control batteries.

■ Recommended Inspection

- After used over several seasons, the unit will become dirty and thus decreases the unit's performance. Depending on the operation conditions, a dirty unit may produce odour and dust may pollute dehumidification system. Therefore, a seasonal inspection is recommended in addition to regular cleaning. (Consult an authorized dealer).

HELPFUL INFORMATION

■ Auto Operation Button

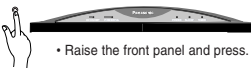

- Raise the front panel and press.

● Automatic Operation

- If the remote control fails to function or has been misplaced, press the Auto Operation button to start the Automatic operation.
- The Automatic operation will be activated immediately once the Auto operation button is pressed. However, temperature cannot be adjusted in this operation.
- The power indicator on the indoor unit will blink until the operation mode is selected automatically.
- To cancel this operation, press once more.

● Remote Control Signal Receiving Sound

- To switch off the beep (Signal Receiving Sound), press the Auto Operation button for 10 seconds continuously or longer.
"Beep", "beep" sound will be heard at the tenth seconds.
Note: "Beep" sound will be heard at the fifth seconds;
However please press continuously until you heard "beep", "beep" sound.
- Repeat the above steps if you want to switch on the Signal Receiving Sound.

● (This is for Servicing purposes only.)

- Note: If you press this button continuously for 5 to 10 seconds, Test Run operation will be performed. A "beep" sound will be heard at the fifth seconds indicating the Test Run starts to operate.

■ Auto Restart Control

- If power is resumed after a power failure, the operation will restart automatically after 3 - 4 minutes.
- Operation will be restarted automatically under the previous operation mode and airflow direction when power is resumed as the operation is not stopped by the remote control.

■ Timer Setting

- When power failure occurs, the timer setting will be cancelled. Once power is resumed, reset the timer.

■ Thunder and Lightning

- This air conditioner is equipped with a built-in surge protective device. However, in order to further protect your air conditioner from being damaged by abnormally strong lightning activity, you may switch off the main power supply and unplug from power socket.

ENERGY SAVING AND OPERATION HINTS

■ Setting the Temperature

- Approximately 10% of electricity can be saved.
- Set the temperature higher or lower than the desired temperature.

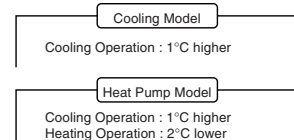

■ Air Filters and Air Purifying Filters

- Clean the air filters every 2 weeks and the Air Purifying Filters every 6 months.
- Dirty filters may reduce cooling or heating efficiency.

■ Keep All Doors and Windows Closed

- Otherwise, cooling or heating performance will be reduced and electricity cost is wasted.

■ Outdoor Unit

- Do not block the air outlet vents. Otherwise, it will lower the cooling or heating performance.

■ Timer and Sleep Mode

- To prevent wastage of electricity, use sleep mode when sleeping or Timer when going out.

■ Avoid Direct Sunlight

- Keep curtains or drapes closed to avoid direct sunlight during cooling operation.

TROUBLESHOOTING

■ Normal Operation

Is it okay?	This is the answer
<ul style="list-style-type: none"> • Air conditioner has been restarted, but does not operate for 3 minutes. • A sound like water flowing can be heard. 	<ul style="list-style-type: none"> • This is to protect the air conditioner. Wait until the air conditioner begins to operate. • This is the sound of refrigerant flowing inside the air conditioner.
<ul style="list-style-type: none"> • It seems that fog is coming out from the air conditioner. • The room has a peculiar odour. 	<ul style="list-style-type: none"> • Condensation occurs when the airflow from the air conditioner cools the room. • This may be a damp smell emitted by the wall, carpet, furniture or clothing in the room.
<ul style="list-style-type: none"> • During Automatic Fan Speed setting, indoor fan stops occasionally. • The outdoor unit emits water or steam. 	<ul style="list-style-type: none"> • This is to remove smell emitted by the surroundings. • In COOL/DRY operation, moisture in the air condenses into water on the cool surface of outdoor unit piping that causes dripping.
<ul style="list-style-type: none"> • (For Heat Pump Model only) Operation stops for about 12 minutes during heating (The power indicator blinks). 	<ul style="list-style-type: none"> • This is to melt the frost which has accumulated on the outdoor unit (defrosting operating). This will take no longer than about 12 minutes. Water drips from the outdoor unit. Wait until this operation ends. (the power indicator will light up). (Frost will accumulate on the outdoor unit when the outdoor temperature is low and humidity is high.)
<ul style="list-style-type: none"> • (For Heat Pump Model only) During heating operation, indoor fan may run at on and off conditions. 	<ul style="list-style-type: none"> • This is to prevent undesired cooling effect during heating operation.

■ Abnormal Operation

Is it okay?	Please check
<ul style="list-style-type: none"> • The air conditioner does not operate. 	<ul style="list-style-type: none"> • Has the circuit breaker been tripped? • Has the power plug been removed from the wall outlet? • Is the timer being used correctly?
<ul style="list-style-type: none"> • Air conditioner produces loud noise during operation. 	<ul style="list-style-type: none"> • Is the installation work slanted? • Is the front grille closed properly?
<ul style="list-style-type: none"> • The air conditioner does not cool or warm effectively. 	<ul style="list-style-type: none"> • Has the temperature been set incorrectly? • Are the filters dirty? • Are the intake or outlet vents of the outdoor unit obstructed? • Are all windows and doors closed?
<ul style="list-style-type: none"> • Remote control / display doesn't work. 	<ul style="list-style-type: none"> • Batteries empty? • Batteries correctly inserted (+) and (-)?

■ Call the Dealer Immediately

If the following conditions occur, turn off and unplug the main power supply, and then call the dealer immediately.

- **Abnormal noise is heard during operation.**
- **Water or foreign material gets into the remote control by mistake.**
- **Water leak from the indoor unit.**
- **Switches or buttons do not operate properly.**
- **The circuit breaker switches off frequently.**
- **Power supply cord and plug become unusually warm.**





10 Installation Instructions

Required tools for Installation Works			
1. Philips screw driver	5. Spanner	9. Gas leak detector	13. Multimeter
2. Level gauge	6. Pipe cutter	10. Measuring tape	14. Torque wrench 18 N.m (1.8 kgf.m) 55 N.m (5.5 kgf.m) 65 N.m (6.5 kgf.m)
3. Electric drill, hole core drill (ø70 mm)	7. Reamer	11. Thermometer	15. Vacuum pump
4. Hexagonal wrench (4 mm)	8. Knife	12. Megameter	16. Gauge manifold

10.1. Safety Precautions

- Read the following “SAFETY PRECAUTIONS” carefully before installation.
- Electrical work must be installed by a licensed electrician. Be sure to use the correct rating of the power plug and main circuit for the model to be installed.
- The caution items stated here must be followed because these important contents are related to safety. The meaning of each indication used is as below. Incorrect installation due to ignoring of the instruction will cause harm or damage, and the seriousness is classified by the following indications.



 WARNING	This indication shows the possibility of causing death or serious injury.
--	---

 CAUTION	This indication shows the possibility of causing injury or damage to properties only.
--	---

The items to be followed are classified by the symbols:

	Symbol with background white denotes item that is PROHIBITED from doing.
---	--

- Carry out test running to confirm that no abnormality occurs after the installation. Then, explain to user the operation, care and maintenance as stated in instructions. Please remind the customer to keep the operating instructions for future reference.

 WARNING	
1. Engage dealer or specialist for installation. If installation done by the user is defective, it will cause water leakage, electrical shock or fire.	
2. Install according to this installation instruction strictly. If installation is defective, it will cause water leakage, electrical shock or fire.	
3. Use the attached accessories parts and specified parts for installation. Otherwise, it will cause the set to fall, water leakage, fire or electrical shock.	
4. Install at a strong and firm location which is able to withstand the set's weight. If the strength is not enough or installation is not properly done, the set will drop and cause injury.	
5. For electrical work, follow the local national wiring standard, regulation and this installation instruction. An independent circuit and single outlet must be used. If electrical circuit capacity is not enough or defect found in electrical work, it will cause electrical shock or fire.	
6. Use the specified cable (2.5 mm ²) and connect tightly for indoor/outdoor connection. Connect tightly and clamp the cable so that no external force will be acted on the terminal. If connection or fixing is not perfect, it will cause heat-up or fire at the connection.	
7. Wire routing must be properly arranged so that control board cover is fixed properly. If control board cover is not fixed perfectly, it will cause heat-up at connection point of terminal, fire or electrical shock.	
8. When carrying out piping connection, take care not to let air substances other than the specified refrigerant go into refrigeration cycle. Otherwise, it will cause lower capacity, abnormal high pressure in the refrigeration cycle, explosion and injury.	
9. Do not damage or use unspecified power supply cord. Otherwise, it will cause fire or electrical shock.	
10. Do not modify the length of the power supply cord or use of the extension cord, and do not share the single outlet with other electrical appliances. Otherwise, it will cause fire or electrical shock.	









CAUTION

1. The equipment must be earthed. It may cause electrical shock if grounding is not perfect.
2. Do not install the unit at place where leakage of flammable gas may occur. In case gas leaks and accumulates at surrounding of the unit, it may cause fire. 
3. Carry out drainage piping as mentioned in installation instructions. If drainage is not perfect, water may enter the room and damage the furniture.

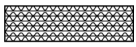
ATTENTION

1. Selection of the installation location.
Select a installation location which is rigid and strong enough to support or hold the unit, and select a location for easy maintenance.
2. Power supply connection to the room air conditioner.
Connect the power supply cord of the room air conditioner to the mains using one of the following method.
Power supply point shall be the place where there is ease for access for the power disconnection in case of emergency.
In some countries, permanent connection of this room air conditioner to the power supply is prohibited.
 1. Power supply connection to the receptacle using a power plug.
Use an approved 16A power plug with earth pin for 2.0HP (C18BK, A18BK, V18BK, W18BK, V18CK, W18CK) and 20A for 2.5HP (C24BK, A24BK, XC24BK, V24BK, W24BK, V24CK, W24CK) for the connection to the receptacle.
 2. Power supply connection to a circuit breaker for the permanent connection. Use an approved 16A circuit breaker 2.0HP (C18BK, A18BK, V18BK, W18BK, V18CK, W18CK) and 20A for 2.5HP (C24BK, A24BK, XC24BK, V24BK, W24BK, V24CK, W24CK) for the permanent connection. It must be a double pole switch with a minimum 3 mm contact gap.
3. Do not release refrigerant.
Do not release refrigerant during piping work for installation, reinstallation and during repairing a refrigeration parts. Take care of the liquid refrigerant, it may cause frostbite.
4. Installation work.
It may need two people to carry out the installation work.
5. Do not install this appliance in a laundry room or other location where water may drip from the ceiling, etc.

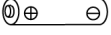
Attached accessories

No.	Accessories part	Qty.	No.	Accessories part	Qty.
1	Installation plate 	1	6	Solar refreshing deodorizing filter 	1
2	Installation plate fixing screw 	6	7	Remote Control holder 	1
3	Remote control 	1	8	Remote Control holder fixing screw 	2
4	Battery 	2	9	Drain elbow (A18BK, A24BK, W18BK, W24BK, W18CK, W24CK) 	1
5	Air purifying filter 	1			

Applicable piping kit

CZ-4F5, 7, 10AN (C18BK, A18BK, V18BK, W18BK, V18CK, W18CK)

CZ-52F5, 7, 10AN (C24BK, A24BK, XC24BK, V24BK, W24BK, V24CK, W24CK)

SELECT THE BEST LOCATION

INDOOR UNIT

- There should not be any heat source or steam near the unit.
- There should not be any obstacles blocking the air circulation.
- A place where air circulation in the room is good.
- A place where drainage can be easily done.
- A place where noise prevention is taken into consideration.
- Do not install the unit near the door way.
- Ensure the spaces indicated by arrows from the wall, ceiling, fence or other obstacles.
- Recommended installation height for indoor unit shall be at least 2.3 m.

OUTDOOR UNIT

- If an awning is built over the unit to prevent direct sunlight or rain, be careful that heat radiation from the condenser is not obstructed.
- There should not be any animal or plant which could be affected by hot air discharged.
- Keep the spaces indicated by arrows from wall, ceiling, fence or other obstacles.
- Do not place any obstacles which may cause a short circuit of the discharged air.
- If piping length is over 7.5m, additional refrigerant should be added as shown in the table.

Model	Piping size		Rated Length (m)	Max. Elevation (m)	Max. Piping Length (m)	Additional Refrigerant (g/m)
	Gas	Liquid				
C18BK, V18BK, V18CK	1/2"	1/4"	5	20	25	20
C24BK, V24BK, XC24BK, V24CK	5/8"	1/4"	5	20	25	30
A18BK, W18BK, W18CK	1/2"	1/4"	5	20	25	20
A24BK, W24BK, W24CK	5/8"	1/4"	5	20	25	30

Example: For A24BK

If the unit will be installed at a 10m distance, the quantity of additional refrigerant should be 75g...(10 - 7.5)m × 30g/m = 75g

Indoor/Outdoor Unit Installation Diagram

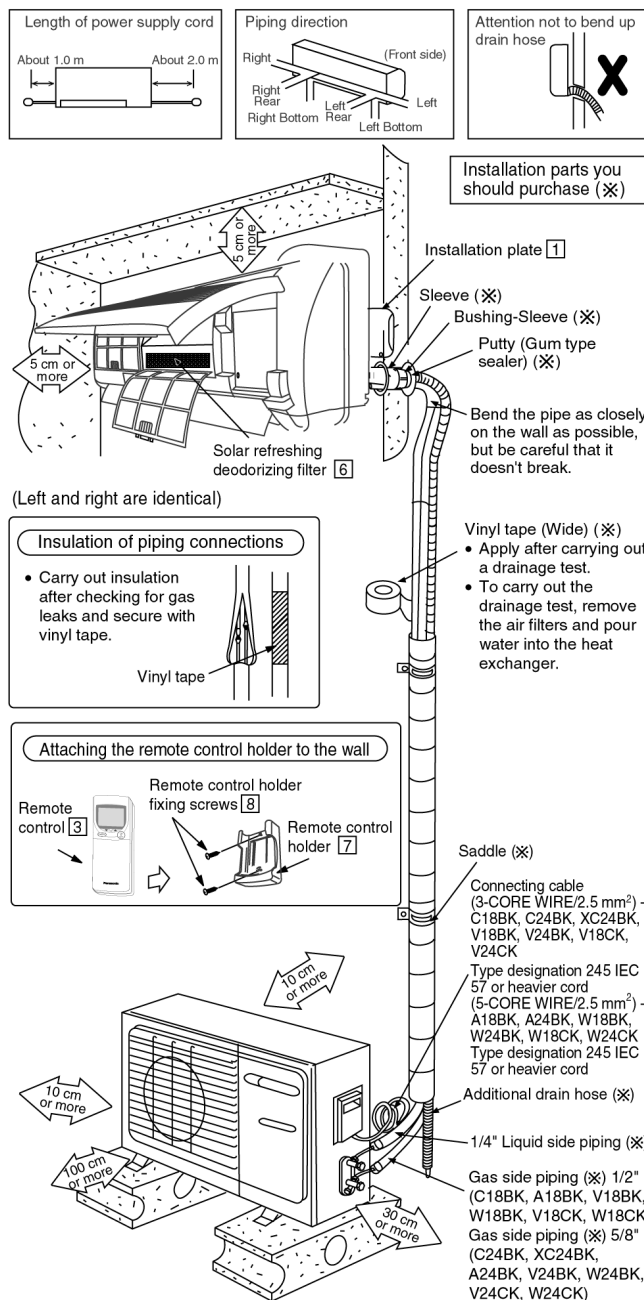

• This illustration is for explanation purposes only. The indoor unit will actually face a different way.

10.2. INDOOR UNIT

10.2.1. SELECT THE BEST LOCATION (Refer to “Select the best location” section)

10.2.2. HOW TO FIX INSTALLATION PLATE

The mounting wall is strong and solid enough to prevent it from the vibration.

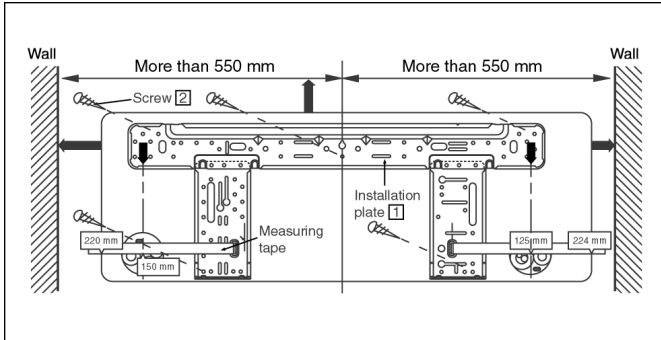

The centre of installation plate should be at more than 550 mm at right and left of the wall.

The distance from installation plate edge to ceiling should more than 67 mm.

From installation plate left edge to unit's left side is 47 mm.

From installation plate right edge to unit's right is 73 mm.

- Ⓑ : For left side piping, piping connection for liquid should be about 126 mm from this line.
- : For left side piping, piping connection for gas should be about 174 mm from this line.
- : For left side piping, piping connecting cable should be about 984 mm from this line.

1. Mount the installation plate on the wall with 5 screws or more.

(If mounting the unit on the concrete wall consider using anchor bolts.)

- Always mount the installation plate horizontally by aligning the marking-off line with the thread and using a level gauge.

2. Drill the piping plate hole with $\phi 70$ mm hole-core drill.

- Line according to the arrows marked on the lower left and right side of the installation plate. The meeting point of the extended line is the centre of the hole. Another method is by putting measuring tape at position as shown in the diagram above. The hole centre is obtained by measuring the distance namely 150 mm and 125 mm for left and right hole respectively.
- Drill the piping hole at either the right or the left and the hole should be slightly slanted to the outdoor side.

10.2.3. TO DRILL A HOLE IN THE WALL AND INSTALL A SLEEVE OF PIPING

1. Insert the piping sleeve to the hole.
2. Fix the bushing to the sleeve.
3. Cut the sleeve until it extrudes about 15 mm from the wall.

Caution

When the wall is hollow, please be sure to use the sleeve for tube ass'y to prevent dangers caused by mice biting the connecting cable.

4. Finish by sealing the sleeve with putty or caulking compound at the final stage.

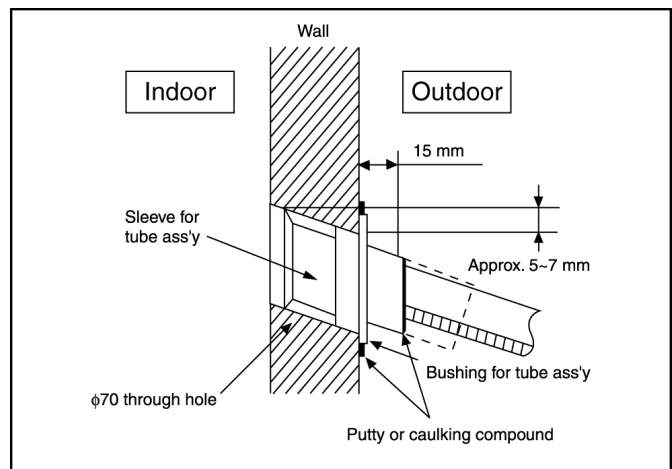

10.2.4. INDOOR UNIT INSTALLATION

1. For the right rear piping

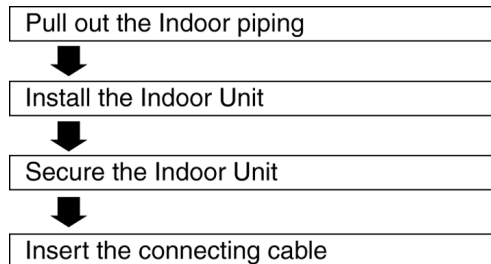

2. For the right and right bottom piping

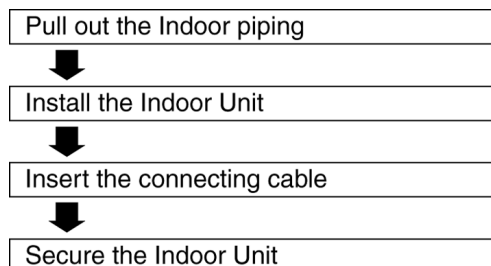

3. For the embedded piping

- Replace the drain hose
- ↓
- Bend the embedded piping
 - Use a spring bender or equivalent to bend the piping so that the piping is not crushed.
- ↓
- Install the Indoor Unit
- ↓
- Cut and flare the embedded piping
 - When determining the dimension of the piping, slide the unit all the way to the left on the installation plate.
 - Refer to the section "Cutting and flaring the piping".
- ↓
- Pull the connecting cable into Indoor Unit
 - The inside and outside connecting cable can be connected without removing the front grille.
- ↓
- Connect the piping
 - Please refer to "Connecting the piping" column in outdoor unit section. (Below steps are done after connecting the outdoor piping and gas-leakage confirmation.)
- ↓
- Insulate and finish the piping
 - Please refer to "Piping and finishing" column of outdoor section and "Insulation of piping connections" column as mentioned in Indoor/Outdoor Unit Installation.
- ↓
- Secure the Indoor Unit

Install the Indoor Unit

Hook the indoor unit onto the upper portion of installation plate (Engage the indoor unit with the upper edge of the installation plate). Ensure the hooks are properly seated on the installation plate by moving in left and right.

Secure the Indoor Unit

1. Tape the extra power supply cord in a bundle and keep it behind the chassis.
 - Ensure that the power supply cord is not clamped in between the unit's hook (2 positions) and installation plate.
2. Press the lower left and right side of the unit against the installation plate until hooks engages with their slots (sound click).

Pull out the piping and drain hose

Move the drain hose near to arrow mark and tape it with piping in a position as mentioned in Fig. below

To take out the unit, push the [PUSH] marking at the bottom unit, and pull it slightly towards you to disengage the hooks from the unit.

(This can be used for left rear piping & left bottom piping also.)

How to keep the cover

In case of the cover is cut, keep the cover at the rear of chassis as shown in the illustration for future reinstallation.

(Left, right and 2 bottom covers for piping)

Exchange the drain hose and the cap

Refer view for left piping installation

Adjust the piping slightly downwards

Insert the connecting cable

Length of connecting cable	Gas side piping	Liquid side piping
134 cm		
Cable		

- How to pull the piping and drain hose out, in case of the embedded piping.

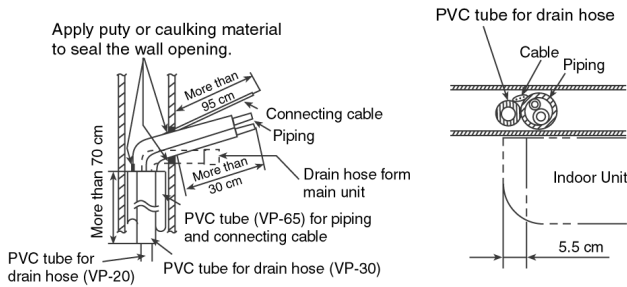

- In case of left piping how to insert the connecting cable and drain hose.

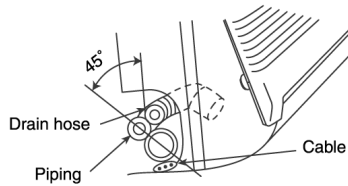

(For the right piping, follow the same procedure)

10.2.5. CONNECT THE CABLE TO THE INDOOR UNIT

- The inside and outside connecting cable can be connected without removing the front grille.
- Connecting cable between indoor unit and outdoor unit shall be approved polychloroprene sheathed 3 (C18BK, C24BK, XC24BK, V18BK, V24BK, V18CK, V24CK) or 5 (A18BK, A24BK, W18BK, W24BK, W18CK, W24CK) × 2.5 mm² flexible cord, type designation 245 IEC 57 or heavier cord.

- Ensure the color of wires of outdoor unit and the terminal Nos. are the same to the indoor's respectively.
- Earth lead wire shall be longer than the other lead wires as shown in the figure for the electrical safety in case of the slipping out of the cord from the anchorage.

CS/CU-C18BK, C24BK, XC24BK, V18BK, V24BK, V18CK, V24CK

Terminals on the indoor unit	1	2	
Color of wires			
Terminals on the outdoor unit	1	2	

CS/CU-A18BK, A24BK, W18BK, W24BK, W18CK, W24CK

Terminals on the indoor unit	1	2	3	4	
Color of wires					
Terminals on the outdoor unit	1	2	3	4	

- Secure the cable onto the control board with the holder (clammer).

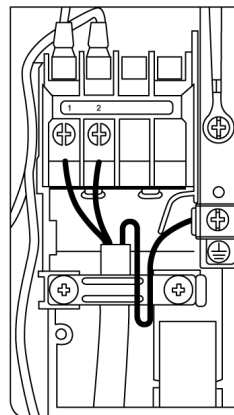

C18BK, C24BK, XC24BK, V18BK, V24BK, V18CK, V24CK

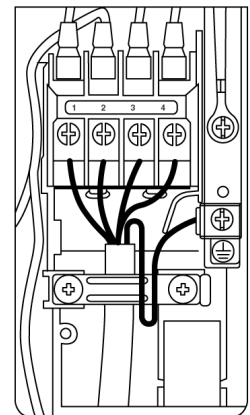

A18BK, A24BK, W18BK, W24BK, W18CK, W24CK

INSTALLATION OF AIR PURIFYING FILTERS

- Open the front panel.
- Remove the air filters.
- Put air purifying filters (left) and solar refreshing deodorizing filter (right) into place as shown in illustration below.

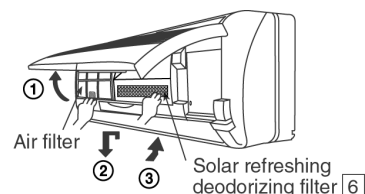

HOW TO TAKE OUT FRONT GRILLE

Please follow the steps below to take out front grille if necessary such as when servicing.

1. Set the vertical airflow direction louver to the horizontal position.
2. Slide down the three caps on the front grille as shown in the illustration below, and then remove the three mounting screws.
3. Pull the lower section of the front grille towards you to remove the front grille.

When reinstalling the front grille, first set the vertical airflow direction louver to the horizontal position and then carry out above steps 2 - 3 in the reverse order.

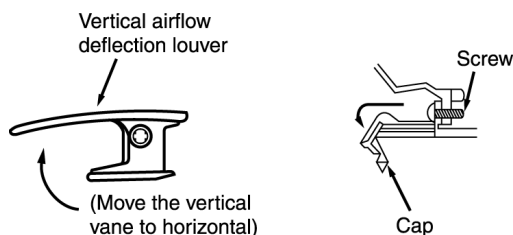

AUTO SWITCH OPERATION

The below operations will be performed by pressing the "AUTO" switch.

1. AUTO OPERATION MODE

The Auto operation will be activated immediately once the Auto Switch is pressed.

2. TEST RUN OPERATION (FOR PUMP DOWN/SERVICING PURPOSE)

The Test Run operation will be activated if the Auto Switch is pressed continuously for more than 5 sec. to below 10 sec.. A "pep" sound will occur at the fifth sec., in order to identify the starting of Test Run operation

3. REMOTE CONTROLLER RECEIVING SOUND ON/OFF

The ON/OFF of Remote Controller receiving sound can be change over by pressing the "AUTO" Switch continuously for 10 sec. and above. A "pep", "pep" sound will occur at the tenth sec., in order to indicate the "ON/OFF" change over of remote control receiving sound.

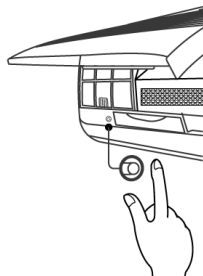

10.3. OUTDOOR UNIT

10.3.1. SELECT THE BEST LOCATION (Refer to "Select the best location" section)

10.3.2. INSTALL THE OUTDOOR UNIT

- After selecting the best location, start installation according to Indoor/Outdoor Unit Installation Diagram.

1. Fix the unit on concrete or rigid frame firmly and horizontally by bolt nut. ($\phi 10$ mm).
2. When installing at roof, please consider strong wind and earthquake. Please fasten the installation stand firmly with bolt or nails.

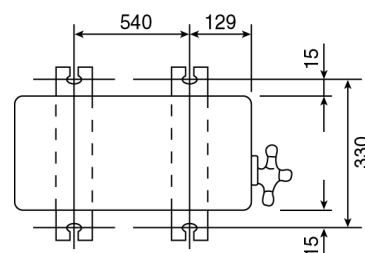

10.3.3. CONNECTING THE PIPING

Connecting The Piping To Indoor Unit

Please make flare after inserting flare nut (locate at joint portion of tube assembly) onto the copper pipe. (In case of using long piping)

Connect the piping

- Align the center of piping and sufficiently tighten the flare nut with fingers.
- Further tighten the flare nut with torque wrench in specified torque as stated in the table.

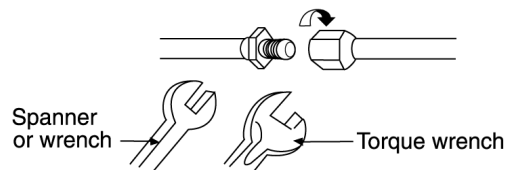

MODEL	Piping size (Torque)	
	Gas	Liquid
C18BK, A18BK V18BK, W18BK V18CK, W18CK	1/2" (55 N.m)	1/4" (18 N.m)
C24BK, A24BK, XC24BK, V24BK, W24BK, V24CK, W24CK	5/8" (65 N.m)	1/4" (18 N.m)

Connecting The Piping To Outdoor Unit

Decide piping length and then cut by using pipe cutter. Remove burrs from cut edge. Make flare after inserting the flare nut (located at valve) onto the copper pipe.

Align center of piping to valves and then tighten with torque wrench to the specified torque as stated in the table.

CUTTING AND FLARING THE PIPING

1. Please cut using pipe cutter and then remove the burrs.
2. Remove the burrs by using reamer. If burrs is not removed, gas leakage may be caused.
Turn the piping end down to avoid the metal powder entering the pipe.
3. Please make flare after inserting the flare nut onto the copper pipes.

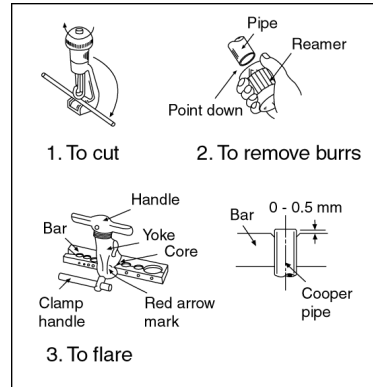

■ Improper flaring ■

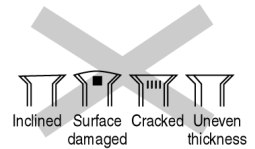

When properly flared, the internal surface of the flare will evenly shine and be of even thickness. Since the flare part comes into contact with the connections, carefully check the flare finish.

10.3.4. (a) EVACUATION OF THE EQUIPMENT (FOR EUROPE & OCEANIA DESTINATION)

WHEN INSTALLING AN AIR CONDITIONER, BE SURE TO EVACUATE THE AIR INSIDE THE INDOOR UNIT AND PIPES in the following procedure.

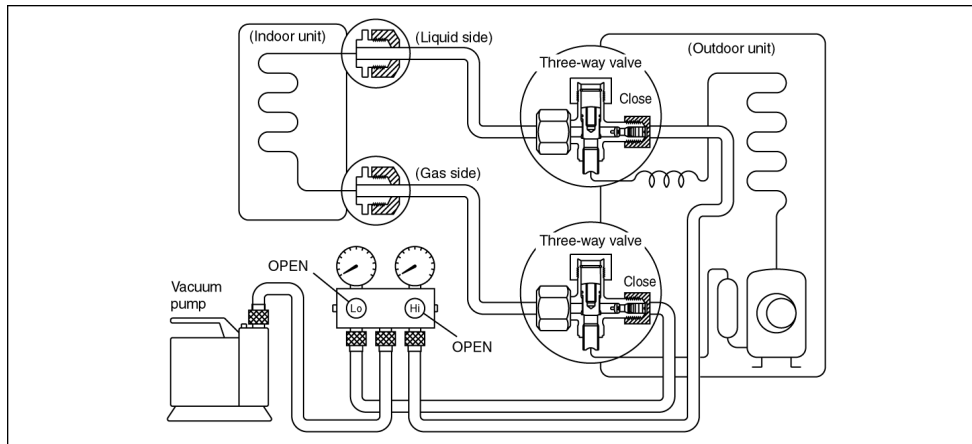

1. Connect a charging hose with a push pin to the Low and High side of a charging set and the service port of the 3-way valve.
 - Be sure to connect the end of the charging hose with the push pin to the service port.
2. Connect the center hose of the charging set to a vacuum pump.
3. Turn on the power switch of the vacuum pump and make sure that the needle in the gauge moves from 0 cmHg (0 MPa) to -76 cmHg (-0.1 MPa). Then evacuate the air approximately ten minutes.
4. Close the valve of both the Low and High sides of the charging set and turn off the vacuum pump. Make sure that the needle in the gauge does not move after approximately five minutes.

Note: BE SURE TO FOLLOW THIS PROCEDURE IN ORDER TO AVOID REFRIGERANT GAS LEAKAGE.
5. Disconnect the charging hose from the vacuum pump and from the service port of the 3-way valve.
6. Tighten the service port caps of the 3-way valve at a torque of 18 N.m with a torque wrench.
7. Remove the valve caps of both of the 2-way valve and 3-way valve. Position both of the valves to "OPEN" using a hexagonal wrench (4 mm).
8. Mount valve caps onto the 2-way valve and the 3-way valve.
 - Be sure to check for gas leakage.

CAUTION

- If gauge needle does not move from 0 cmHg (0 MPa) to -76 cmHg (-0.1 MPa), in step 3 above take the following measure:
 - If the leak stops when the piping connections are tightened further, continue working from step 3.
 - If the leak does not stop when the connections are retightened, repair the location of leak.
 - Do not release refrigerant during piping work for installation and reinstallation. Take care of the liquid refrigerant, it may cause frostbite.

10.3.5. (b) AIR PURGING OF THE PIPING AND INDOOR UNIT

- 1) Checking a gas leakage.
 1. Remove the service-port cap from the 3-way valves.
 2. Connect the Manifold gauge set to the service port of Liquid side 3-way valve.
 3. Connect the Charging Cylinder to the Manifold gauge set and open the valve of the Cylinder.
 4. Open the low pressure side valve of the Manifold gauge for approx. 10 seconds and then close.
 5. Check gas-leakage of the connecting portion of pipings with the gas-leak detector.

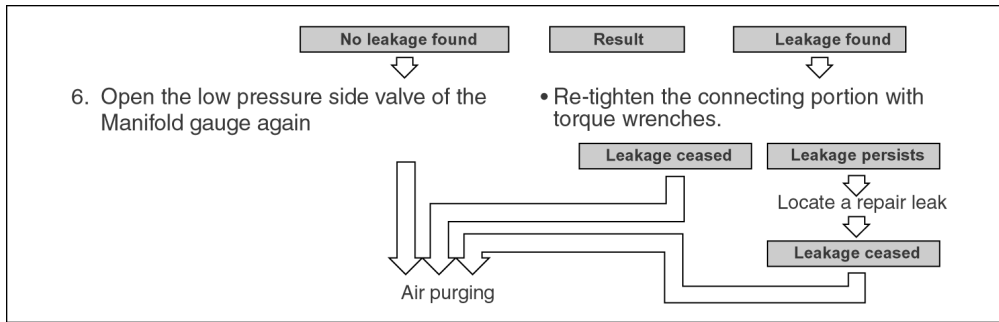
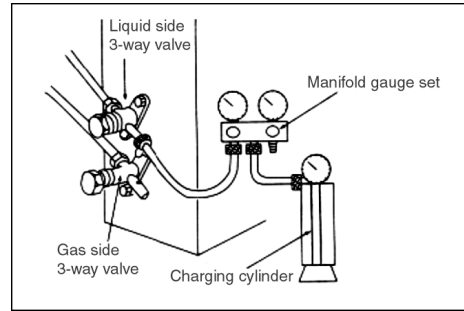

<For the left pipings>.

- 1) Measure the pressure.
 - 2) Keep it for 5-10 minutes
 - Ensure if the pressure indicated on the gauge is as same as that of measured at first time
- 2) Air purging

The air remaining in the Refrigeration cycle which contains moisture may cause malfunction on the Compressor.

1. To purge the air, push the pin on the Gas side 3-way valve for three seconds with a Hexagonal wrench and set it free for one minute.
 - Repeat this for three times.
2. To balance the refrigerant, close the low pressure side valve on the Manifold gauge and release refrigerant from the piping through service port until the gauge indicates 0.5 - 0.3 MPa.
3. Set both 3-way valves to open position with the Hexagonal wrench for the unit operation.

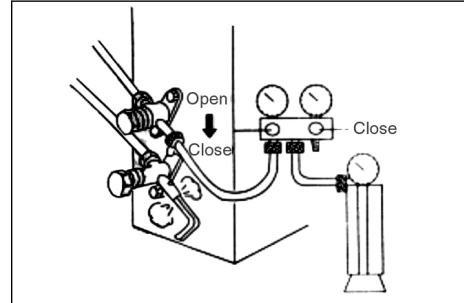

10.3.6. CONNECT THE CABLE TO THE OUTDOOR UNIT

1. Remove the control board cover from the unit by loosening the screw.
2. Connecting cable between indoor unit and outdoor unit shall be approved polychloroprene sheathed 3 (C18BK, C24BK, XC24BK, V18BK, V24BK, V18CK, V24CK) or 5 (A18BK, A24BK, W18BK, W24BK, W18CK, W24CK) × 2.5 mm² flexible cord, type designation 245 IEC 57 or heavier cord.

CS/CU-C18BK, C24BK, XC24BK, V18BK, V24BK, V18CK, V24CK			
Terminals on the indoor unit	1	2	⊕
Color of wires	Grey	Black	Black
Terminals on the outdoor unit	1	2	⊕

CS/CU-A18BK, A24BK, W18BK, W24BK, W18CK, W24CK					
Terminals on the indoor unit	1	2	3	4	⊕
Color of wires	Grey	Black	Black	Black	Black
Terminals on the outdoor unit	1	2	3	4	⊕

3. Secure the cable onto the control board with the holder (clammer).
4. Attach the control board cover back to the original position with the screw.

10.3.7. PIPE INSULATION

1. Please carry out insulation at pipe connection portion as mentioned in Indoor/Outdoor Unit Installation Diagram. Please wrap the insulated piping end to prevent water from going inside the piping.
2. If drain hose or connecting piping is in the room (where dew may form), please increase the insulation by using POLY-E FOAM with thickness 6 mm or above.

DISPOSAL OF OUTDOOR UNIT DRAIN WATER

- If a drain elbow is used, the unit should be placed on a stand which is taller than 3 cm.
- If the unit is used in an area where temperature falls below 0°C for 2 or 3 days in succession, it is recommended not to use a drain elbow, for the drain water freezes and the fan will not rotate.

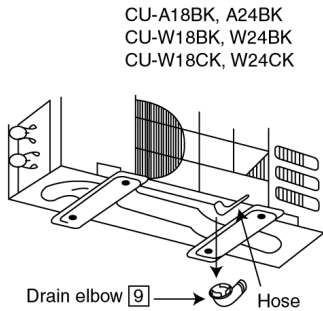

Install the hose at an angle so that the water smoothly flows out.

CHECK THE DRAINAGE

- Open front panel and remove air filters. (Drainage checking can be carried out without removing the front grille.)
- Pour a glass of water into the drain tray-styrofoam.
- Ensure that water flows out from drain hose of the indoor unit.

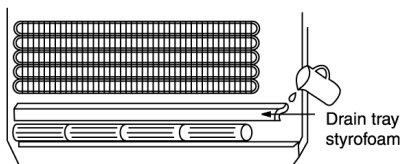

EVALUATION OF THE PERFORMANCE

- Operate the unit at cooling operation mode for fifteen minutes or more.
- Measure the temperature of the intake and discharge air.
- Ensure the difference between the intake temperature and the discharge is more than 8°C.

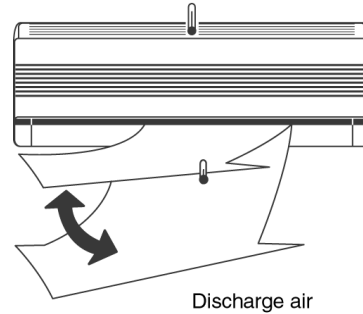

NOTE:

These equipment shall be connected to a suitable mains network with a main impedance less than the following:

- CS / CU-C18BKP5: 0.20 Ω
- CS / CU-A18BKP5: 0.20 Ω
- CS / CU-C24BKP5: 0.12 Ω
- CS / CU-A24BKP5: 0.14 Ω
- CS / CU-V24CKP5: 0.17 Ω
- CS / CU-W24CKP5: 0.07 Ω

CHECK ITEMS

- Is there any gas leakage at flare nut connections?
- Has the heat insulation been carried out at flare nut connection?
- Is the connecting cable being fixed to terminal board firmly?
- Is the connecting cable being clamped firmly?
- Is the drainage OK?
(Refer to "Check the drainage" section)
- Is the earth wire connection properly done?
- Is the indoor unit properly hooked to the installation plate?
- Is the power supply voltage complied with rated value?
- Is there any abnormal sound?
- Is the cooling operation normal?
- Is the thermostat operation normal?
- Is the remote control's LCD operation normal?
- Is the air purifying filter installed?

11 Installation and Servicing Air Conditioner Using R410A

11.1. OUTLINE

11.1.1. About R410A Refrigerant

1. Converting air conditioners to R410A

Since it was declared in 1974 that chlorofluorocarbons (CFC), hydro chlorofluorocarbons (HCFC) and other substances pose a destructive danger to the ozone layer in the earth's upper stratosphere (20 to 40 km above the earth), measures have been taken around the world to prevent this destruction.

The R22 refrigerant which has conventionally been used in ACs is an HCFC refrigerant and, therefore, possesses this ozone-destroying potential. International regulations (the Montreal Protocol Ozone-Damaging Substances) and the domestic laws of various countries call for the early substitution of R22 by a refrigerant which will not harm the ozone layer.

- In ACs, the HFC refrigerant which has become the mainstream alternative called R410A. Compared with R22, the pressure of R410A is approximately 1.6 times as high at the same refrigerant temperature, but the energy efficiency is about the same. Consisting of hydrogen (H), fluorine (F) and carbon (C), R410A is an HFC refrigerant. Another typical HFC refrigerant is R407C. While the energy efficiency of R407C is somewhat inferior to that of R410A, it offers the advantage of having pressure characteristics which are about the same as those of R22, and is used mainly in packaged ACs.

2. The characteristics of HFC (R410A) refrigerants

a. Chemical characteristics

The chemical characteristics of R410A are similar to those of R22 in that both are chemically stable, non-flammable refrigerants with low toxicity.

However, just like R22, the specific gravity of R410A gas is heavier than that of air. Because of this, it can cause an oxygen deficiency if it leaks into a closed room since it collects in the lower area of the room. It also generates toxic gas when it is directly exposed to a flame, so it must be used in a well ventilated environment where it will not collect.

Table 1 Physical comparison of R410A and R22

	R410A	R22
Composition (wt%)	R32/R125 (50/50)	R22 (100)
Boiling point (°C)	-51.4	-40.8
Vaporizing pressure (25°C)	1.56 Mpa (15.9 kgf/cm ²)	0.94 Mpa (9.6 kgf/cm ²)
Saturated vapor density	64.0 kg/m ³	44.4 kg/m ³
Flammability	Non-flammable	Non-flammable
Ozone-destroying point (ODP)	0	0.005
Global-warming point (GWP)	1730	1700

b. Compositional change (pseudo-azeotropic characteristics)

R410A is a pseudo-azeotropic mixture comprising the two components R32 and R125. Multi-component refrigerants with these chemical characteristics exhibit little compositional change even from phase changes due to vaporization (or condensation), which means that there is little change in the circulating refrigerant composition even when the refrigerant leaks from the gaseous section of the piping.

Accordingly, R410A can be handled in almost the same manner as the single-component refrigerant R22. However, when charging, because there is a slight change in composition between the gas phase and the liquid phase inside a cylinder or other container, charging should basically begin with the liquid side.

c. Pressure characteristics

As seen in Table 2, the gas pressure of R410A is approximately 1.6 times as high as that of R22 at the same refrigerant temperature, which means that special R410A tools and materials with high-pressure specifications must be used for all refrigerant piping work and servicing.

Table 2 Comparison of R410A and R22 saturated vapor density

Refrigerant Temperature (°C)	Unit: MPa	
	R410A	R22
-20	0.30	0.14
0	0.70	0.40
20	1.35	0.81
40	2.32	1.43
60	3.73	2.33
65	4.15	2.60

d. R410A refrigerating machine oil

Conventionally, mineral oil or a synthetic oil such as alkylbenzene has been used for R22 refrigerating machine oil. Because of the poor compatibility between R410A and conventional oils like mineral oil, however, there is a tendency for the refrigerating machine oil to collect in the refrigerating cycle. For this reason, polyester and other synthetic oils which have a high compatibility with R410A are used as refrigerating machine oil.

Because of the high hygroscopic property of synthetic oil, more care must be taken in its handling than was necessary with conventional refrigerating machine oils. Also, these synthetic oils will degrade if mixed with mineral oil or alkylbenzene, causing clogging in capillary tubes or compressor malfunction. Do not mix them under any circumstances.

11.1.2. Safety Measure When Installing / Receiving Refrigerant Piping

Cause the gas pressure of R410A is approximately 1.6 times as high as that of R22, a mistake in installation or servicing could result in a major accident. It is essential that you use R410a tools and materials, and that you observe the following precautions to ensure safety.

1. Do not use any refrigerant other than R410A in ACs that have been used with R410A.
2. If any refrigerant gas leaks while you are working, ventilate the room. Toxic gas may be generated if refrigerant gas is exposed to a direct flame.
3. When installing or transferring an AC, do not allow any air or substance other than R410A to mix into the refrigeration cycle. If it does, the pressure in the refrigeration cycle can become abnormally high, possibly causing an explosion and/or injury.
4. After finishing the installation, check to make sure there is no refrigerant gas leaking.
5. When installing or transferring an AC, follow the instructions in the installation instructions carefully. Incorrect installation can result in an abnormal refrigeration cycle or water leakage, electric shock, fire, etc.
6. Do not perform any alterations on the AC unit under any circumstances. Have all repair work done by a specialist. Incorrect repairs can result in an water leakage, electric shock, fire, etc.

11.2. TOOL FOR INSTALLING / SERVICING REFRIGERANT PIPING

11.2.1. Necessary Tools

In order to prevent an R410A AC from mistakenly being charged with any other refrigerant, the diameter of the 3-way valve service port on the outdoor unit has been changed. Also, to increase its ability to withstand pressure, the opposing dimensions have been changed for the refrigerant pipe flaring size and flare nut. Accordingly, when installing or servicing refrigerant piping, you must have both the R410A and ordinary tools listed below.

Table 3 Tools for installation, transferring or replacement

Type of work	Ordinary tools	R410A tools
Flaring	Flaring tool (clutch type), pipe cutter, reamer	Copper pipe gauge for clearance Adjustment, flaring tool (clutch type)*1)
Bending, connecting pipes	Torque wrench (nominal diameter 1/4, 3/8, 1/2) Fixed spanner (opposing sides 12 mm, 17 mm, 19 mm) Adjustable wrench, Spring bender	
Air purging	Vacuum pump Hexagonal wrench (opposing sides 4 mm)	Manifold gauge, charging hose, vacuum pump adaptor
Gas leak inspection	Gas leak inspection fluid or soapy water	Electric gas leak detector for HFC refrigerant*2)

*1) You can use the conventional (R22) flaring tool. If you need to buy a new tool, buy the R410A type.

*2) Use when it is necessary to detect small gas leaks.

For other installation work, you should have the usual tools, such as screwdrivers (+,-), a metal-cutting saw, an electrical drill, a hole core drill (65 or 70 dia.), a tape measure, a level, a thermometer, a clamp meter, an insulation tester, a voltmeter, etc.

Table 4 Tools for serving

Type of work	Ordinary tools	R410A tools
Refrigerant charging		Electronic scale for refrigerant charging Refrigerant cylinder Charging orifice and packing for refrigerant cylinder
Brazing (Replacing refrigerating cycle part*1)	Nitrogen blow set (be sure to use nitrogen blowing for all brazing), and brazing), and brazing machine	

*1) Always replace the dryer of the outdoor unit at the same time. The replacement dryer is wrapped in a vacuum pack. Replace it last among the refrigerating cycle parts. Start brazing as soon as you have opened the vacuum pack, and begin the vacuuming operation within 2 hours.

11.2.2. R410A Tools

1. Cooper tube gauge for clearance adjustment
(used when flaring with the conventional flaring tool (clutch type))

- This gauge makes it easy to set the clearance for the copper tube to 1.0-1.5 mm from the clamp bar of the flaring tool.

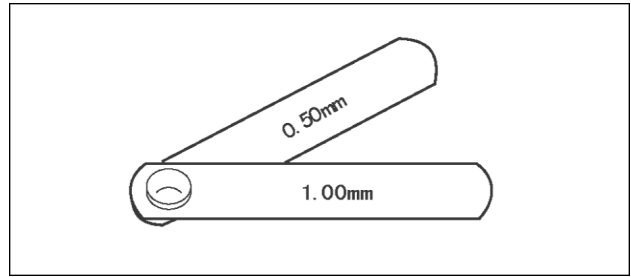

Fig. 1 Copper tube gauge for clearance adjustment

2. Flaring tool (clutch type)

- In the R410A flaring tool, the receiving hole for the clamp bar is enlarged so the clearance from the clamp bar can be set to 0-0.5 mm, and the spring inside the tool is strengthened to increase the strength of the pipe-expanding torque. This flaring tools can also be used with R22 piping, so we recommend that you select it if you are buying a new flaring tool.

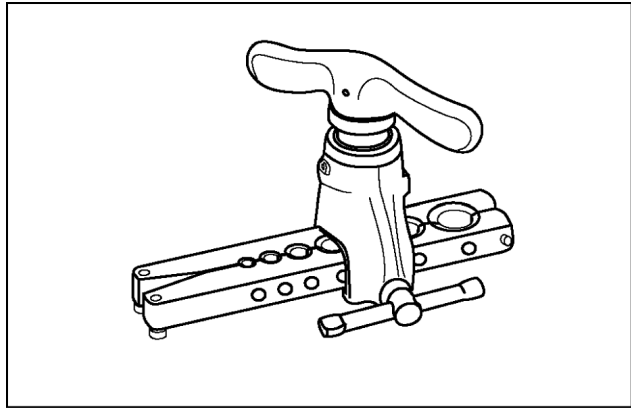

Fig. 2 Flaring tool (clutch type)

3. Torque wrenches

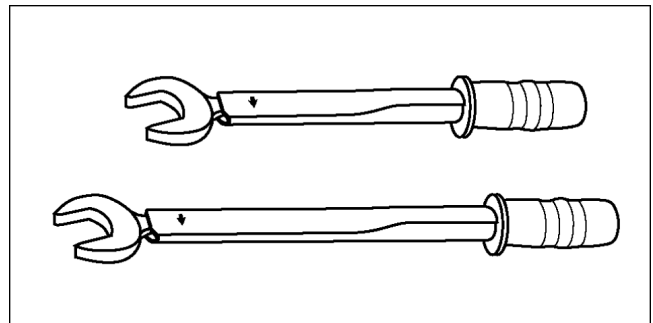

Fig. 3 Torque wrenches

Table 5

	Conventional wrenches	R410A wrenches
For 1/4 (opposite side x torque)	17 mm x 18 N.m (180 kgf.cm)	17 mm x 18 N.m (180 kgf.cm)
For 3/3 (opposite side x torque)	22 mm x 42 N.m (180 kgf.cm)	22 mm x 42 N.m (180 kgf.cm)
For 1/2 (opposite side x torque)	24 mm x 55 N.m (180 kgf.cm)	26 mm x 55 N.m (180 kgf.cm)

4. Manifold gauge

- Because the pressure is higher for the R410A type, the conventional type cannot be used.

Table 6 Difference between R410A and conventional high / low-pressure gauges

	Conventional wrenches	R410A wrenches
High-pressure gauge (red)	-76 cmHg - 35 kgf/cm ³	-0.1 - 5.3 Mpa -76 cmHg - 53 kgf/cm ³
High-pressure gauge (blue)	-76 cmHg - 17 kgf/cm ³	-0.1 - 3.8 Mpa -76 cmHg - 38 kgf/cm ³

- The shape of the manifold ports has been changed to prevent the possibility of mistakenly charging with another type of refrigerant.

Table 7 Difference between R410A and conventional manifold port size

	Conventional gauges	R410A gauges
Port size	7/6 UNF 20 threads	1/2 UNF 20 threads

5. Charging hose

- The pressure resistance of the charging hose has been raised to match the higher pressure of R410A. The hose material has also been changed to suit HFC use, and the size of the fitting has been changed to match the manifold ports.

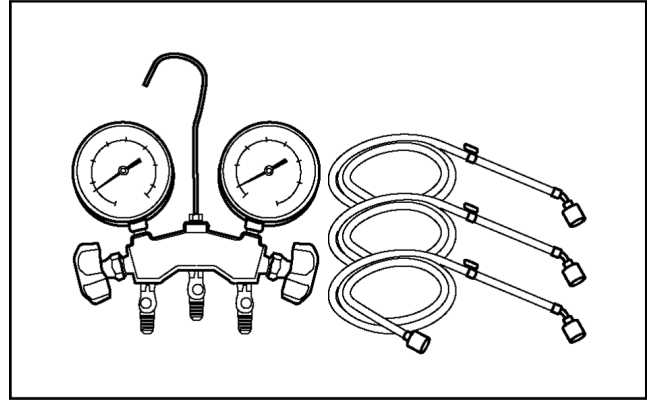

Fig. 4 Manifold gauge charging hose

Table 8 Difference between R410A and conventional charging hoses

		Conventional hoses	R410A hoses
Pressure resistance	Working pressure	3.4 MPa (35 kgf/cm ³)	5.1 MPa (52 kgf/cm ³)
	Bursting pressure	17.2 MPa (175 kgf/cm ³)	27.4 MPa (280 kgf/cm ³)
Material		NBR rubber	HNBR rubber Nylon coating inside

6. Vacuum pump adaptor

- When using a vacuum pump for R410A, it is necessary to install an electromagnetic valve to prevent the vacuum pump oil from flowing back into the charging hose. The vacuum pump adaptor is installed for that purpose. If the vacuum pump oil (mineral oil) becomes mixed with R410A, it will damage the unit.

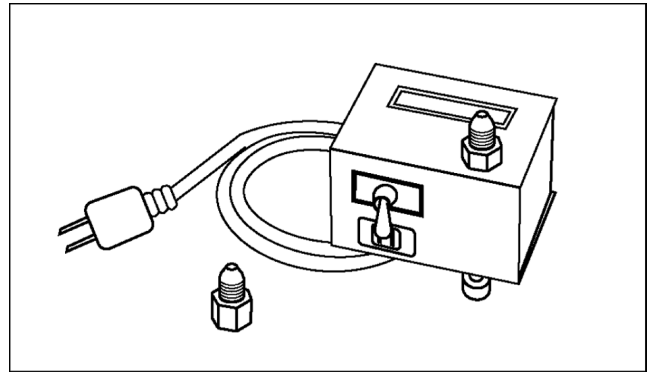

Fig. 5 Vacuum pump adaptor

7. Electric gas leak detector for HFC refrigerant

- The leak detector and halide torch that were used with CFC and HCFC cannot be used with R410A (because there is no chlorine in the refrigerant).
- The present R134a leak detector can be used, but the detection sensitivity will be lower (setting the sensitivity for R134a at 1, the level for R410A will drop to 0.6).
- For detecting small amounts of gas leakage, use the electric gas leak detector for HFC refrigerant. (Detection sensitivity with R410A is about 23 g/year).

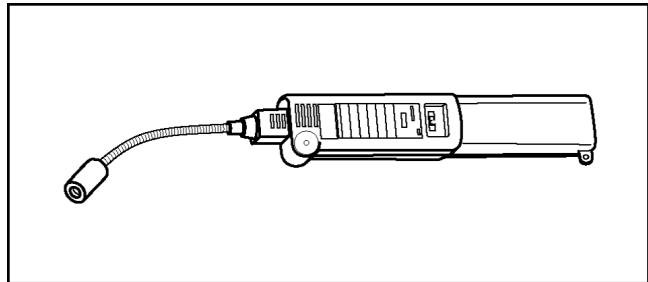

Fig. 6 Electric gas leak detector for HFC refrigerant

8. Electronic scale for refrigerant charging

- Because of the high pressure and fast vaporizing speed of R410A, the refrigerant cannot be held in a liquid phase inside the charging cylinder when charging is done using the charging cylinder method, causing bubbles to form in the measurement scale glass and making it difficult to see the reading. (Naturally, the conventional R22 charging cylinder cannot be used because of the differences in the pressure resistance, scale gradation, connecting port size, etc.)
- The electronic scale has been strengthened by using a structure in which the weight detector for the refrigerant cylinder is held by four supports. It is also equipped with two connection ports, one for R22 (*7/16 UNF, 20 threads) and one for R410A (1/2 UNF, 20 threads), so it can also be used for conventional refrigerant charging.
- There are two types of electronic scales, one for 10-kg cylinders and one for 20-kg cylinders. (The 10-kg cylinder is recommended.)

Refrigerant charging is done manually by opening and closing the valve.

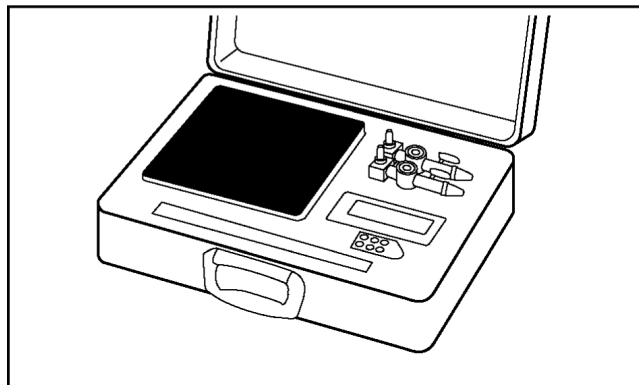

Fig. 7 Electronic scale for refrigerant charging

9. Refrigerant cylinders

- The R410A cylinders are labeled with the refrigerant name, and the coating color of the cylinder protector is pink, which is the color stipulated by ARI of the U.S.
- Cylinder equipped with a siphon tube are available to allow the cylinder to stand upright for liquid refrigerant charging.

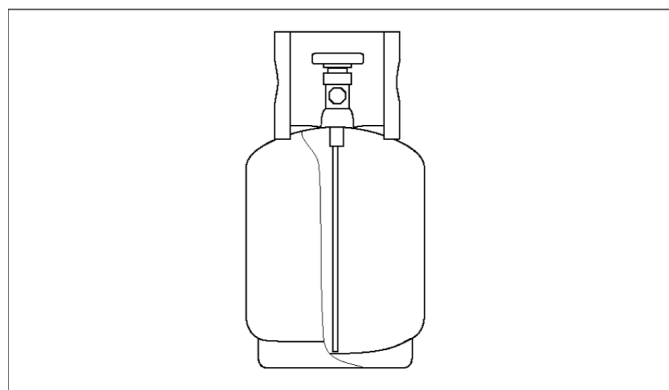

Fig. 8 Refrigerant cylinders

10. Charging orifice and packing for refrigerant cylinders

- The charging orifice must match the size of the charging hose fitting (1/2 UNF, 20 threads).
- The packing must also be made of an HFC-resistant material.

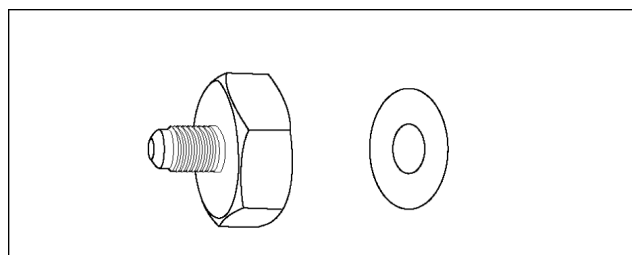

Fig. 9 Charging orifice and packing

11.2.3. R410A Tools Which Are Usable for R22 Models

Table 9 R410A tools which are usable for R22 models

	R410A tools	Usable for R22 models
(1)	Copper tube gauge for clearance adjustment	OK
(2)	Flaring tool (clutch type)	OK
(3)	Manifold gauge	NG
(4)	Charging hose	NG
(5)	Vacuum pump adaptor	OK
(6)	Electric gas leak detector for HFC refrigerant	NG
(7)	Electronic scale for refrigerant charging	OK
(8)	Refrigerant cylinder	NG
(9)	Charging orifice and packing for refrigerant cylinder	NG

11.3. REFRIGERANT PIPING WORK

11.3.1. Piping Materials

It is recommended that you use copper and copper alloy jointless pipes with a maximum oil adherence of 40 mg/10m. Do not use pipes that are crushed, deformed, or discolored (especially the inside surface). If these inferior pipes are used, impurities may clog the expansion valves or capillaries.

Because the pressure of ACs using R410A is higher than those using R22, it is essential that you select materials that are appropriate for these standards.

The thickness of the copper tubing used for R410A is shown in Table 10. Please be aware that tubing with a thickness of only 0.7 mm is also available on the market, but this should never be used.

Table 8 Difference between R410A and conventional charging hoses

Soft pipe		Thickness (mm)	
Nominal diameter	Outside diameter (mm)	R410A	(Reference) R22
1/4	6.35	0.80	0.80
3/8	9.52	0.80	0.80
1/2	12.7	0.80	0.80

11.3.2. Processing and Connecting Piping Materials

When working with refrigerant piping, the following points must be carefully observed: no moisture or dust must be allowed to enter the piping, and there must be no refrigerant leaks.

1. Procedure and precautions for flaring work

a. Cut the pipe

Use a pipe cutter, and cut slowly so the pipe will not be deformed.

b. Remove burrs and clean shavings from the cut surface

If the shape of the pipe end is poor after removing burrs, or if shavings adhere to the flared area, it may lead to refrigerant leaks.

To prevent this, turn the cut surface downward and remove burrs, then clean the surface, carefully.

c. Insert the flare nut (be sure to use the same nut that is used on the AC unit)

d. Flaring

Check the clamp bar and the cleanliness of the copper pipe.

Be sure to use the clamp bar to do the flaring with accuracy. Use either an R410A flaring tool, or a conventional flaring tool. Flaring tools come in different sizes, so be sure to check the size before using. When using a conventional flaring tool, use the copper pipe gauge for clearance adjustment, etc., to ensure the correct A dimension (see Fig. 10)

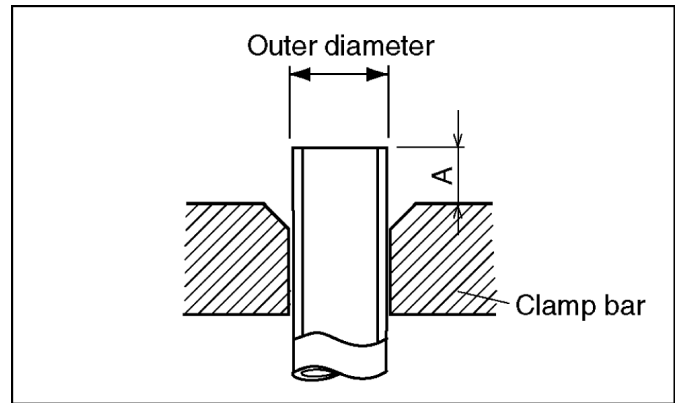

Fig. 10 Flaring dimensions

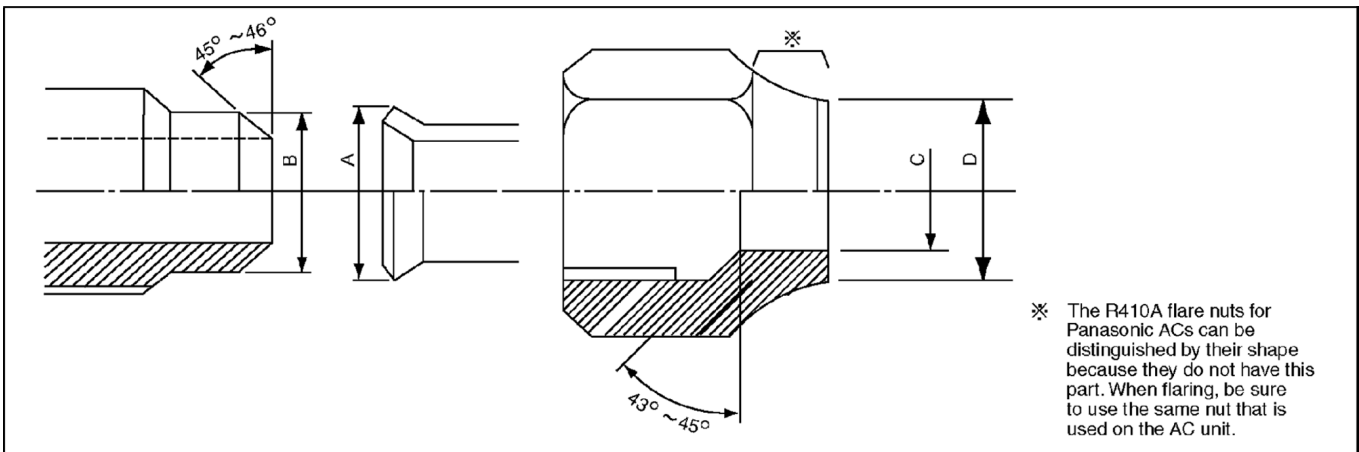

Fig. 11 Relation between the flare nut structure and flaring tool end

Table 11 R410A flaring dimensions

Nominal diameter	Outside diameter (mm)	Wall thickness (mm)	A (mm)		
			R410A flaring tool, clutch type	Conventional flaring tool	
				Clutch type	Wing-nut type
1/4	6.35	0.8	0 - 0.5	1.0 - 1.5	1.5 - 2.0
3/8	9.52	0.8	0 - 0.5	1.0 - 1.5	1.5 - 2.0
1/2	12.70	0.8	0 - 0.5	1.0 - 1.5	2.0 - 2.5

Table 12 R410A flaring dimensions

Nominal diameter	Outside diameter (mm)	Wall thickness (mm)	A (mm)		
			R410A flaring tool, clutch type	Conventional flaring tool	
				Clutch type	Wing-nut type
1/4	6.35	0.8	0 - 0.5	0.5 - 1.0	1.0 - 1.5
3/8	9.52	0.8	0 - 0.5	0.5 - 1.0	1.0 - 1.5
1/2	12.70	0.8	0 - 0.5	0.5 - 1.0	1.5 - 2.0

Table 13 R410A flaring and flare nut dimensions Unit: mm

Nominal diameter	Outside diameter (mm)	Wall thickness (mm)	A +0, -0.4	B dimension	C dimension	D dimension	Flare nut width
1/4	6.35	0.8	9.1	9.2	6.5	13	17
3/8	9.52	0.8	13.2	13.5	9.7	20	22
1/2	12.70	0.8	16.6	16.0	12.9	23	26

Table 14 R410A flaring and flare nut dimensions Unit: mm

Nominal diameter	Outside diameter (mm)	Wall thickness (mm)	A +0, -0.4	B dimension	C dimension	D dimension	Flare nut width
1/4	6.35	0.8	9.0	9.2	6.5	13	17
3/8	9.52	0.8	13.0	13.5	9.7	20	22
1/2	12.70	0.8	16.2	16.0	12.9	20	24

2. Procedure and precautions for flare connection

- Check to make sure there are no scratches, dust, etc., on the flare and union.
- Align the flared surface with the axial center of the union.
- Use a torque wrench, and tighten to the specified torque. The tightening torque for R410A is the same as the conventional torque value for R22. Be careful, because if the torque is too weak, it may lead to a gas leak. If it is too strong, it may split the flare nut or make it impossible to remove the flare nut.

Table 15 R410A tightening torque

Nominal diameter	Outside diameter (mm)	Tightening torque N.m (kgf.cm)	Torque wrench tightening torque N.m (kgf.cm)
1/4	6.35	14 - 18 (140 - 180)	18 (180)
3/8	9.52	33 - 42 (330 - 420)	42 (420)
1/2	12.70	55 (550)	55 (550)

11.3.3. Storing and managing Piping Materials

1. Types of piping and their storage

The following is a general classification of the refrigerant pipe materials used for ACs.

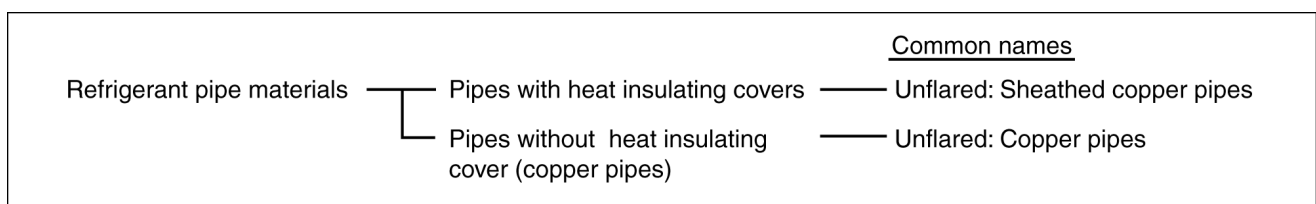

Because the gas pressure of R410A is approximately 1.6 times as high as that of R22, copper pipes with the thickness shown in Table 10, and with minimal impurities must be used. Care must also be taken during storage to ensure that pipes are not crushed, deformed, or scratched, and that no dust, moisture or other substance enters the pipe interior. When storing sheathed copper pipes or plain copper pipes, seal the openings by pinching or taping them securely.

2. Makings and management

a. Sheathed copper pipes and copper-element pipes

When using these pipes, check to make sure that they are the stipulated thickness. For flare nuts, be sure to use the same nut that is used on the AC unit.

b. Copper pipes

Use only copper pipes with the thickness given in table 10, and with minimal impurities. Because the surface of the pipe is exposed, you should take special care, and also take measures such as marking the pipes to make sure they are easily distinguished from other piping materials, to prevent mistaken use.

3. Precautions during refrigerant piping work

Take the following precautions on-site when connecting pipes. (Keep in mind that the need to control the entry of moisture and dust is even more important than in conventional piping).

- a. Keep the open ends of all pipes sealed until connection with AC equipment is complete.
- b. Take special care when doing piping work on rainy days. The entering of moisture will degrade the refrigerating machine oil, and lead to malfunctions in the equipment.
- c. Complete all pipe connections in as short a time as possible. If the pipe must be left standing for a long time after removing the seal, it must be thoroughly purged with nitrogen, or dried with a vacuum pump.

11.4. INSTALLATION, TRANSFERRING, SERVICING

11.4.1. Inspecting Gas Leaks with a Vacuum Pump for New Installations (Using New Refrigerant Piping)

1. From the viewpoint of protecting the global environment, please do not release refrigerant into the atmosphere.
 - a. Connect the projecting side (pin-pushing side) of the charging hose for the manifold gauge to the service port of the 3-way valve. (1)
 - b. Fully open the handle Lo of the manifold gauge and run the vacuum pump. (2) (If the needle of the low-pressure gauge instantly reaches vacuum, re-check step a.)
 - c. Continue the vacuum process for at least 15 minutes, then check to make sure the low-pressure gauge has reached -0.1 MPa (-76 cmHg). Once the vacuum process has finished, fully close the handle Lo of the manifold gauge and stop the vacuum pump operation, then remove the charging hose that is connected to the vacuum pump adaptor. (Leave the unit in that condition for 1-2 minutes, and make sure that the needle of the manifold gauge does not return.) (2) and (3)
 - d. Turn the valve stem of the 2-way valve 90 counter-clockwise to open it, then, after 10 seconds, close it and inspect for a gas leak (4)
 - e. Remove the charging hose from the 3-way valve service port, then open both the 2-way valve and 3-way valve. (1) (4) (Turn the valve stem in the counter-clockwise direction until it gently makes contact. Do not turn it forcefully).
 - f. Tighten the service port cap with a torque wrench (18 N.m (1.8 kgf.m)). (5) Then tighten the 2-way valve and 3-way valve caps with a torque wrench (42 N.m (4.2 kgf.m)) or (55 N.m (5.5 kgf.m)).
 - g. After attaching each of the caps, inspect for a gas leak around the cap area. (5) (6)

Precautions

- Be sure to read the instructions for the vacuum pump, vacuum pump adaptor and manifold gauge prior to use, and follow the instructions carefully.
- Make sure that the vacuum pump is filled with oil up to the designated line on the oil gauge.
- The gas pressure back flow prevention valve on the charging hose is generally open during use. When you are removing the charging hose from the service port, it will come off more easily if you close this valve.

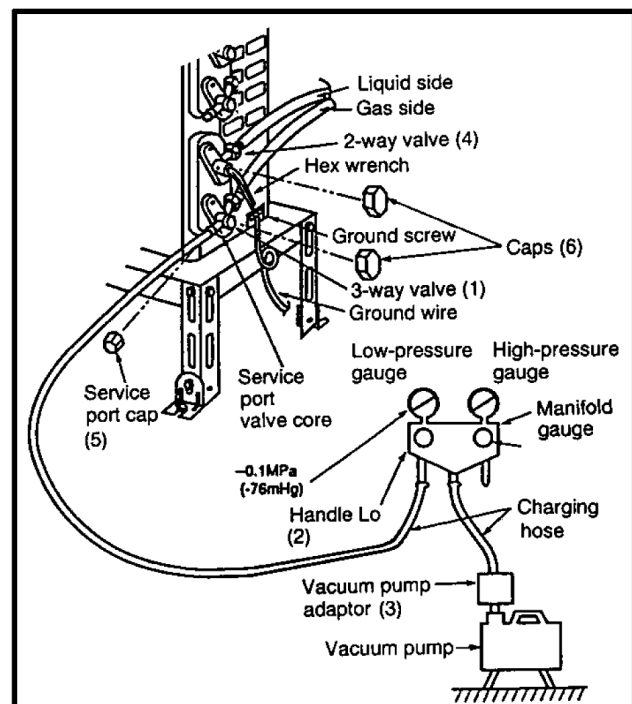

Fig. 12 Vacuum pump air purging configuration

11.4.2. Transferring (Using New Refrigerant Piping)

1. Removing the unit

a. Collecting the refrigerant into the outdoor unit by pumping down

The refrigerant can be collected into the outdoor unit (pumping down) by pressing the TEST RUN button, even when the temperature of the room is low.

- Check to make sure that the valve stems of the 2-way valve and 3-way valve have been opened by turning them counter-clockwise. (Remove the valve stem caps and check to see that the valve stems are fully opened position. Always use a hex wrench (with 4-mm opposing sides) to operate the valve stems.)
- Press the TEST RUN button on the indoor unit, and allow preliminary for 5-6 minutes. (TEST RUN mode)
- After stopping the operation, let the unit sit for about 3 minutes, then close the 2-way valve by turning the valve stem in the clockwise direction.
- Press the TEST RUN button on the indoor unit again, and after 2-3 minutes of operation, turn the valve stem of the 3-way valve quickly in the clockwise direction to close it, then stop the operation.
- Tighten the caps of the 2-way valve and 3-way valve to the stipulated torque.
- Remove the connection pipes (liquid side and gas side).

2. Installing the unit

Install the unit using new refrigerant piping. Follow the instructions in section 4.1 to evacuate the pipes connecting the indoor and outdoor units, and the pipes of the indoor unit, and check for gas leaks.

11.4.3. AC Units Replacement (Using Existing Refrigerant Piping)

When replacing an R410A AC unit with another R410A AC unit, you should re-flare the refrigerant piping. Even though the replacement AC unit uses the R410A, problems occur when, for example, either the AC unit maker or the refrigerating machine oil is different.

When replacing an R22 AC unit with an R410A AC unit, the following checks and cleaning procedures are necessary but are difficult to do because of the chemical characteristics of the refrigerating machine oil (as described in items c) and d) of section 10.1.1.(2)). In this case, you should use new refrigerant piping rather than the existing piping.

1. Piping check

Because of the different pressure characteristics of R22 and R410A, the design pressure for the equipment is 1.6 times different. The wall thickness of the piping must comply with that shown in Table 10, but this is not easy to check. Also, even if the thickness is correct, there may be flattened or bent portions midway through the piping due to sharp curves. Buried sections of the piping also cannot be checked.

2. Pipe cleaning

A large quantity of refrigerating machine oil (mineral oil) adheres to existing pipes due to the refrigeration cycle circulation. If the pipes are used just as they are for the R410A cycle, the capacity will be lowered due to the incompatibility of this oil with the R410A, or irregularities may occur in the refrigeration cycle. For this reason, the piping must be thoroughly cleaned, but this is difficult with the present technology.

11.4.4. Refrigerant Compatibility (Using R410A Refrigerant in R22 ACs and Vice Versa)

Do not operate an existing R22 AC with the new R410A refrigerant. Doing so would result in improper functioning of the equipment or malfunction, and might lead to a major accident such as an explosion in the refrigeration cycle. Similarly, do not operate an R410A AC with R22 refrigerant. The chemical reaction between the refrigerating machine oil used in R410A ACs and the chlorine that is contained in R22 would cause the refrigerating machine oil to degrade and lead to malfunction.

11.4.5. Recharging Refrigerant During Servicing

When recharging is necessary, insert the specified amount of new refrigerant in accordance with the following procedure.

1. Connect the charging hose to the service port of the outdoor unit.
2. Connect the charging hose to the vacuum pump adaptor. At this time, fully open the 2-way valve and 3-way valve.
3. Fully open the handle Lo of the manifold gauge, turn on the power of the vacuum pump and continue the vacuum process for at least one hour.
4. Confirm that the low pressure gauge shows a reading of -0.1 Mpa (-76 cmHg), then fully close the handle Lo, and turn off the vacuum pump. Wait for 1-2 minutes, then check to make sure that the needle of the Low pressure gauge has not returned. See Fig. 13 for the remaining steps of this procedure.

5. Set the refrigerant cylinder onto the electronic scale, then correct the hose the cylinder and to the connection port for the electronic scale. (1)(2)

Precaution:

Be sure to set up the cylinder for liquid charging. If you use a cylinder equipped with a siphon tube, you can charge the liquid without having to turn the cylinder around

6. Remove the charging hose of the manifold gauge from the vacuum pump adaptor, and connect it to the connection port of the electronic scale. (2)(3)
7. Open the valve of the refrigerant cylinder, then open the charging valve slightly and close it. Next, press the check valve of the manifold gauge and purge the air. (2)(4) (Watch the liquid refrigerant closely at this point.)
8. After adjusting the electronic scale to zero, open the charging valve, then open the valve Lo of the manifold gauge and charge with the liquid refrigerant. (2)(5) (Be sure to read the operating instructions for the electronic scale.)
9. If you cannot charge the stipulated amount, operate the unit in the cooling mode while charging a little of the liquid at a time (about 150 g/time as a guideline). If the charging amount is insufficient from one operation, wait about one minute, then use the same procedure to do the liquid charging again.

Precaution:

Never use the gas side to allow a larger amount of liquid refrigerant to be charged while operating the unit.

10. Close the charging valve, and after charging the liquid refrigerant inside the charging hose, fully close the valve Lo of the manifold gauge, and stop the operation of the unit. (2)(5)
11. Quickly remove the charging hose from the service port. (6) If you stop midway through, the refrigerant that is in the cycle will be discharged.
12. After putting on the caps for the service port and operating valve, inspect around the caps for a gas leak. (6)(7)

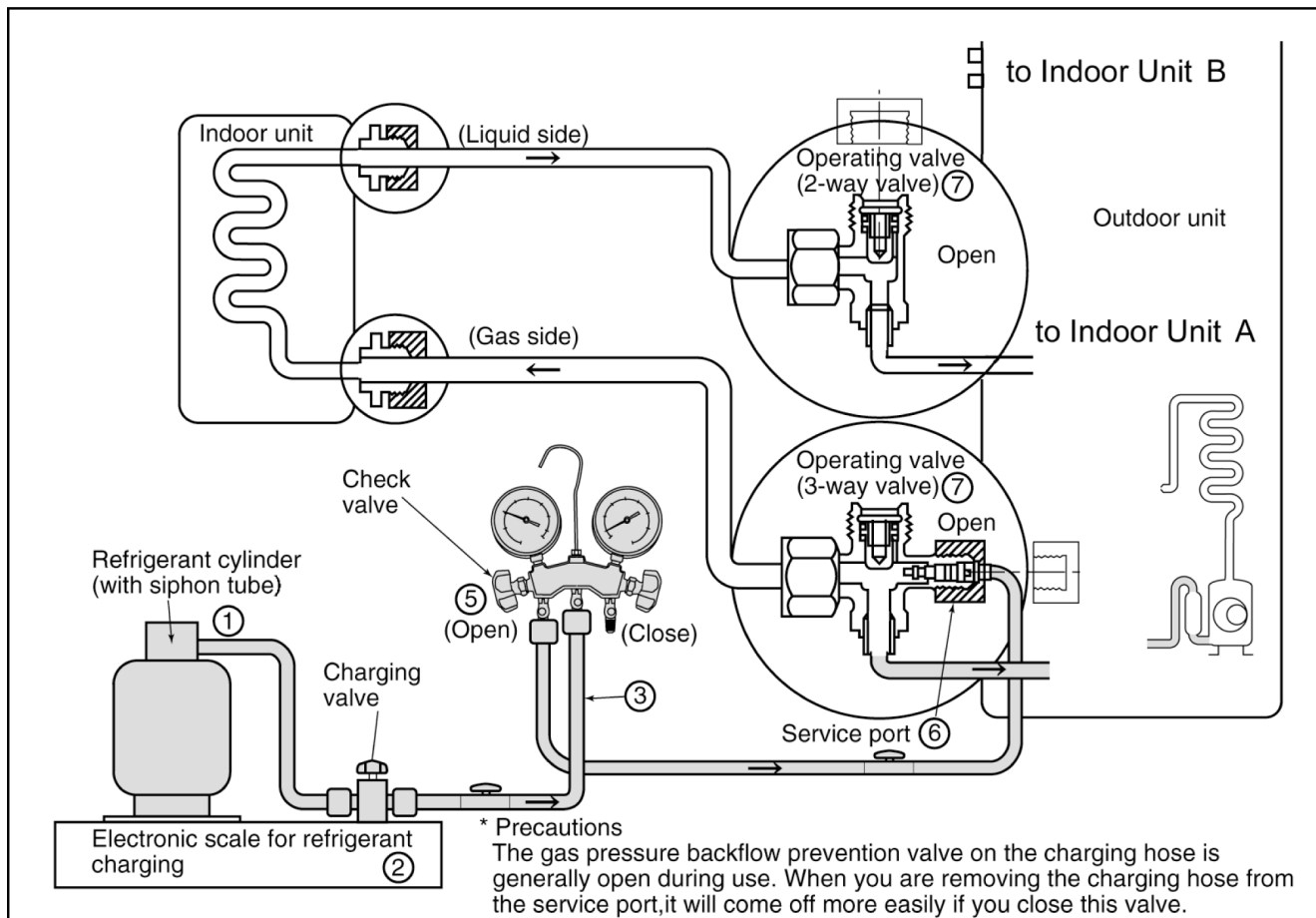

Fig. 13 Re-charging refrigerant

11.4.6. Brazing

As brazing requires sophisticated techniques and experiences, it must be performed by a qualified person.

In order to prevent the oxide film from occurring in the pipe interior during brazing, it is effective to proceed with brazing while letting dry nitrogen gas (N₂) flow.

<Brazing Method for Preventing Oxidation>

1. Attach a reducing valve to the nitrogen gas cylinder.
2. Attach a reducing valve to the nitrogen gas cylinder.
3. Apply a seal onto the clearance between the piping and inserted pipe for the nitrogen gas in order to prevent the nitrogen gas from flowing backward.
4. When the nitrogen gas is flowing, be sure to keep the piping end open.
5. Adjust the flow rate of nitrogen gas so that it is lower than 0.05 m³/h, or 0.02 MPa (0.2 kgf/cm²) by means of the reducing valve.
6. After taking the steps above, keep the nitrogen gas flowing until the piping cools down to a certain extent (i.e. temperature at which pipes are touchable with finger).
7. Completely remove the flux after brazing.

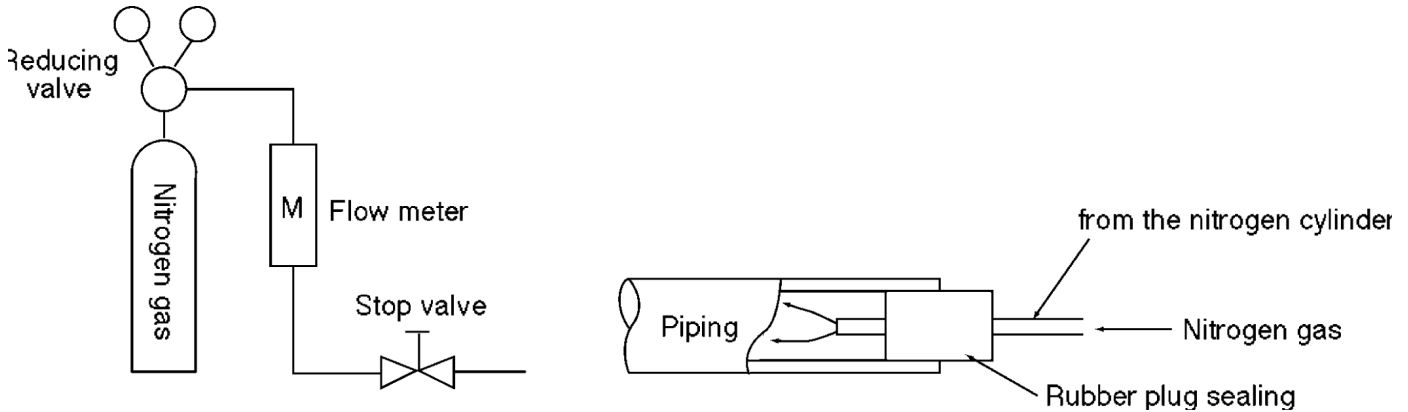

Cautions during brazing

1. General Cautions

- a. The brazing strength should be high as required.
- b. After operation, airtightness should be kept under pressurized condition.
- c. During brazing do not allow component materials to become damaged due to overheating.
- d. The refrigerant pipe work should not become blocked with scale or flux.
- e. The brazed part should not restrict the flow in the refrigerant circuit.
- f. No corrosion should occur from the brazed part.

2. Preventing of Overheating

Due to heating, the interior and exterior surfaces of treated metal may oxidize. Especially, when the interior of the refrigerant circuit oxidizes due to overheating, scale occurs and stays in the circuit as dust, thus exerting a fatally adverse effect. So, make brazing at adequate brazing temperature and with minimum of heating area.

3. Overheating Protection

In order to prevent components near the brazed part from overheating damaged or quality deterioration due to flame or heat, take adequate steps for protection such as (1) by shielding with a metal plate, (2) by using a wet cloth, and (3) by means of heat absorbent.

4. Movement during Brazing

Eliminate all vibration during brazing to protect brazed joints from cracking and breakage.

5. Oxidation Preventative

In order to improve the brazing efficiency, various types of antioxidant are available on the market. However, the constituents of these are widely varied, and some are anticipated to corrode the piping materials, or adversely affect HFC refrigerant, lubricating oil, etc. Exercise care when using an oxidation preventative.

11.4.7. Servicing Tips

The drier must also be replaced whenever replacing the refrigerant cycle parts. Replacing the refrigerant cycle parts first before replacing the drier. The drier is supplied in a vacuum pack. Perform brazing immediately after opening the vacuum pack, and then start the vacuum within two hours. In addition, the drier also needs to be replaced when the refrigerant has leaked completely.

12 Servicing Information

Caution:

- Pb free solder has a higher melting point than standard solder; Typically the melting point is 50 - 70°F (30 - 40°C) higher. Please use a high temperature soldering iron. In case of the soldering iron with temperature control, please set it to 700 ± 20°F (370 ± 10°C).
- Pb free solder will tend to splash when heated too high (about 1100° F/600°C).

12.1. Indoor Electronic Controllers Removal Procedures

1. The Electronic Controller, a Signal Receiver and an Indicator (Fig. 3) can be seen by the below steps:

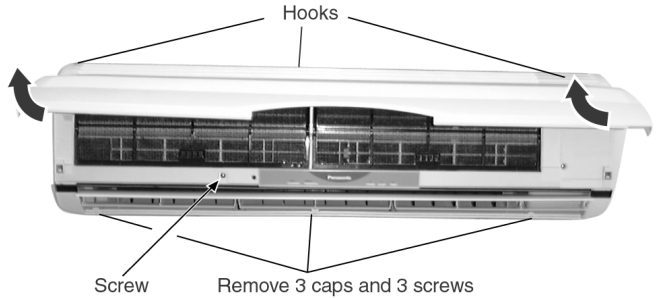

Fig. 1

- Open the Intake Grille and remove the screw at the front of the Front Grille. (Fig. 1).
- Remove the 3 caps and 3 screws at the bottom of the Front Grille. (Fig. 1)
- Remove the Front Grille by releasing the 3 hooks at the top of the Front Grille. (Fig. 1)
- Unhook the tabs at the Control Board to remove the Control Board Cover. (Fig. 2)

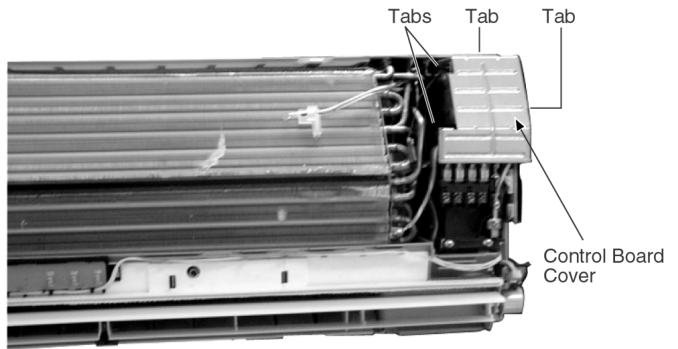

Fig. 2

2. To remove the Electronic Controllers:

- Release the 2 Particular Piece. (Fig. 3)
- Release the CN-REC/DISP connectors. (Fig. 4)
- Release the CN-TH connector. (Fig. 4)
- Release the CN-MAIN connector. (Fig. 4)
- Release the CN-001 connector. (Fig. 4)
- Release the CN-002 connector. (Fig. 4)
- Release the CN-STM1 connector. (Fig. 4)
- Release the CN-STM2 connector. (Fig. 4)
- Release the hooks that hold the Electronic Controller. (Fig. 3)

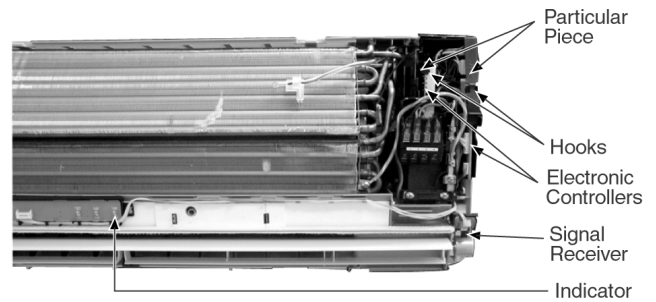

Fig. 3

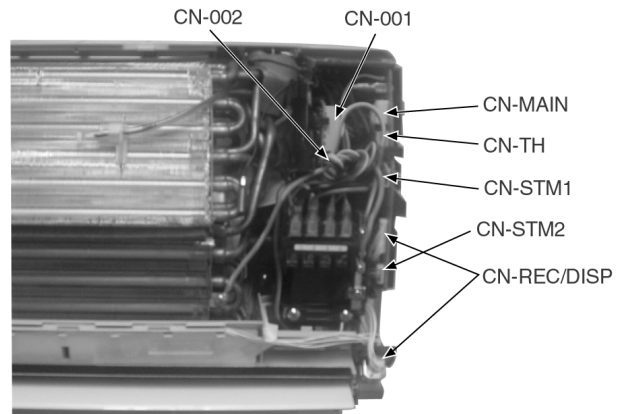

Fig. 4

12.2. Cross Flow Fan Indoor and Fan Motor Removal Procedures

1. In order to remove the Cross Flow Fan and Indoor Fan Motor, Control Board need to be taken out by releasing all the connectors as indicated below.

- a. Release the Earth Wire screw. (Fig. 5)
- b. Release the Intake Air Sensor. (Fig. 5)
- c. Release the Piping Sensor. (Fig. 5)
- d. Release the CN-REC/DISP connectors. (Fig. 5)
- e. Release the CN-STM1 connector. (Fig. 5)

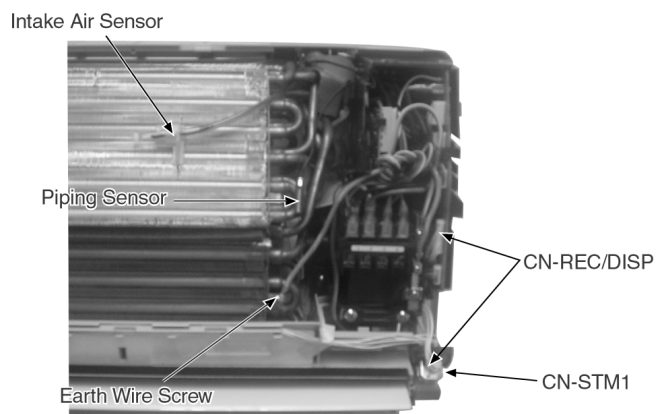

Fig. 5

2. Pull out the Drain Hose from outlet to remove the Discharge Grille. (Fig. 6)

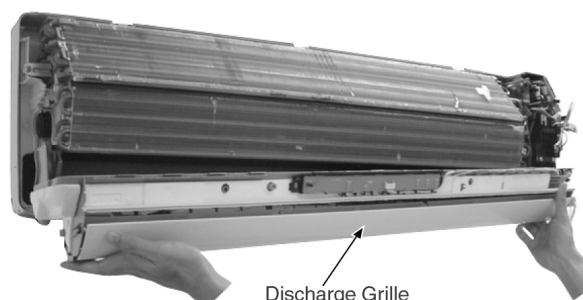

Fig. 6

3. Removing the right and left screws. (Fig. 7)

4. By pressing down the hook at the left and pushing up the hook at the right, you will be able to remove the Control Board. (Fig. 7)

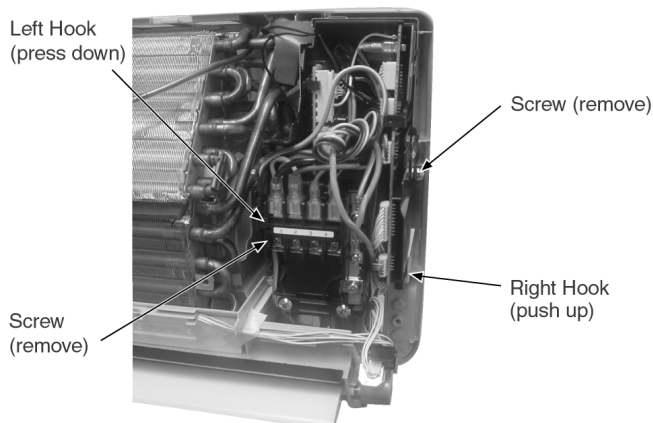

Fig. 7

5. Remove the screw at the Cross Flow Fan. (Fig. 8)

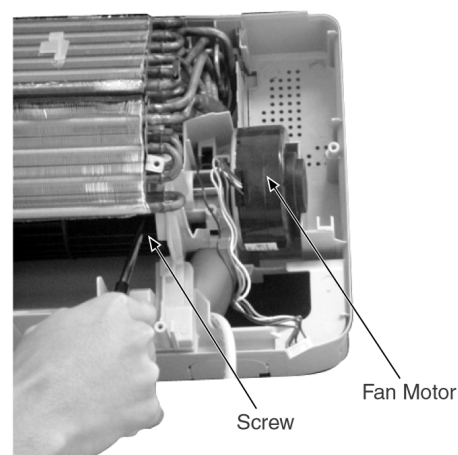

Fig. 8

6. Remove the Bearing. (Fig. 9)

7. Remove the screws at the left of the Evaporator. (Fig. 9)

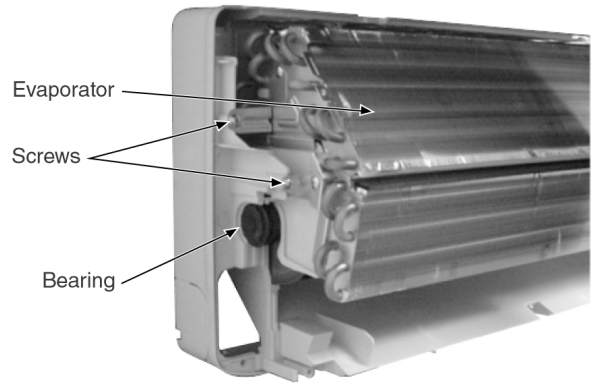

Fig. 9

8. Push up the Evaporator and pull out the Cross Flow Fan from shaft. By then, Fan Motor can be taken out. (Fig. 10).

REMINDER - To reinstall the Fan Motor, put it back in place, adjust the position of the Fan Motor's leadwire appropriately as shown in the Fig. 8 0before installing the Cross Flow Fan.

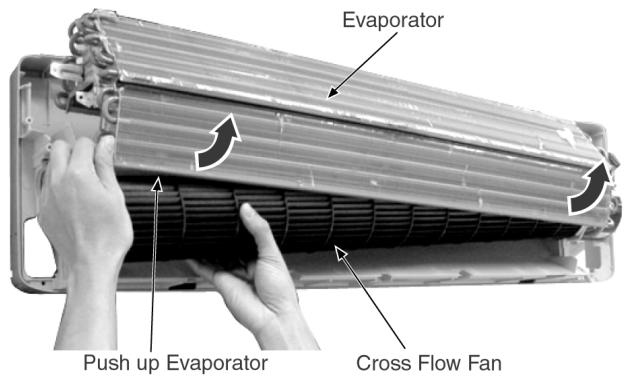
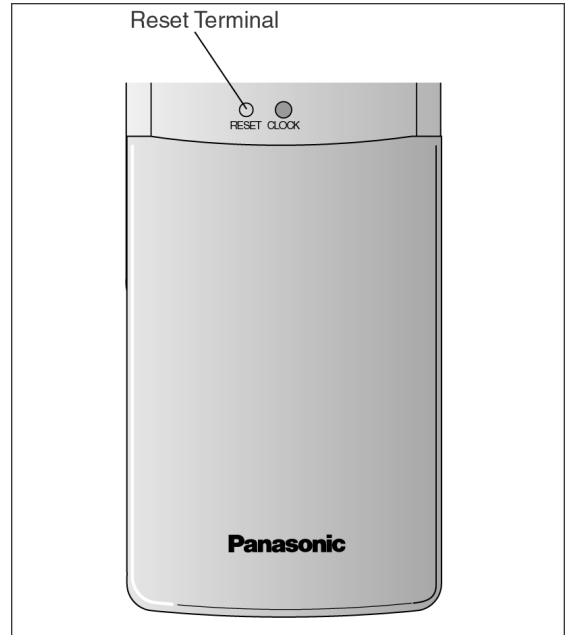

Fig. 10

• **Remote Control Reset**

When the batteries are inserted for the first time, or the batteries are replaced, all the indications will blink and the remote control might not work.

If this happen, remove the cover of the remote control and you will find a resetting terminal, and by shorting it with a minus screwdriver, it will return to normal.



• **Changing the wireless remote control transmission code**

When two indoor units are installed in the same room, in order to prevent operating errors caused by using two remote controls, cut a jumper wire at the remote control printed circuit board (J - A) and cut a jumper wire at the indoor printed circuit board (JX4). It is possible to select from 4 types of transmission codes including one at time of delivery condition (0).

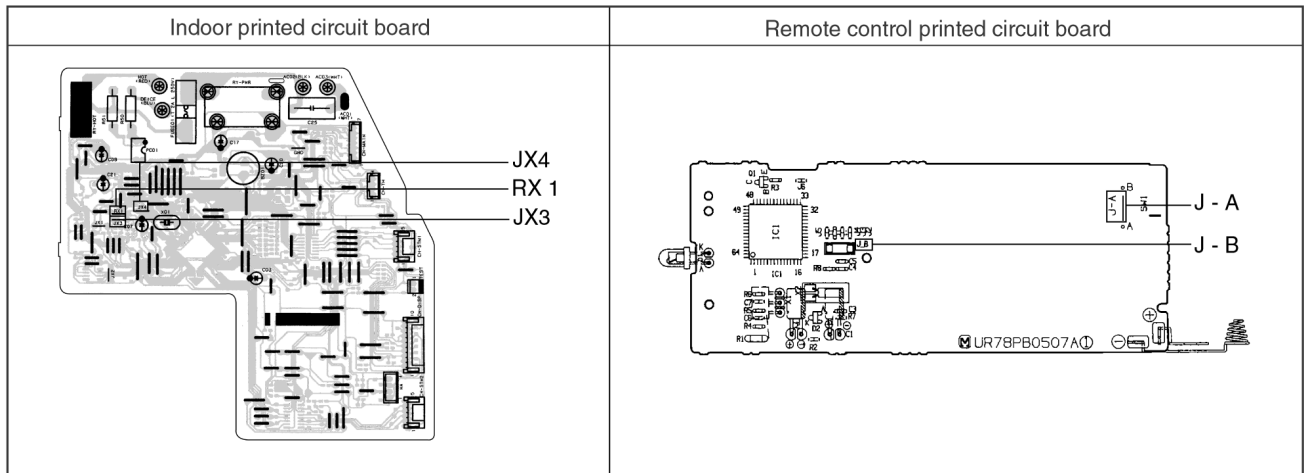

	Remote control printed circuit board		Indoor printed circuit board			Note
	J - A	J - B	JX3	JX4	RX 1	
0	SHORT	OPEN	SHORT	SHORT	—	At product delivery
1	OPEN	OPEN	SHORT	OPEN	—	
2	SHORT	SHORT	OPEN	OPEN	10 KΩ	
3	OPEN	SHORT	SHORT	OPEN	10 KΩ	

13 Troubleshooting Guide

13.1. Refrigeration cycle system

In order to diagnose malfunctions, make sure that there are no electrical problems before inspecting the refrigeration cycle. Such problems include insufficient insulation, problem with the power source, malfunction of a compressor and a fan.

The normal outlet air temperature and pressure of the refrigeration cycle depends on various conditions, the standard values for them are shown in the table on the right.

Normal Pressure and Outlet Air Temperature (Standard)

	Gas pressure Mpa (kg/cm ² G)	Outlet air temperature (°C)
Cooling Mode	0.4 ~ 0.6 (4 ~ 6)	12 ~ 16
Heating Mode	1.5 ~ 2.1 (15 ~ 21)	36 ~ 45

* Condition: Indoor fan speed; High
Outdoor temperature 35°C at the cooling mode and 7°C at the heating mode

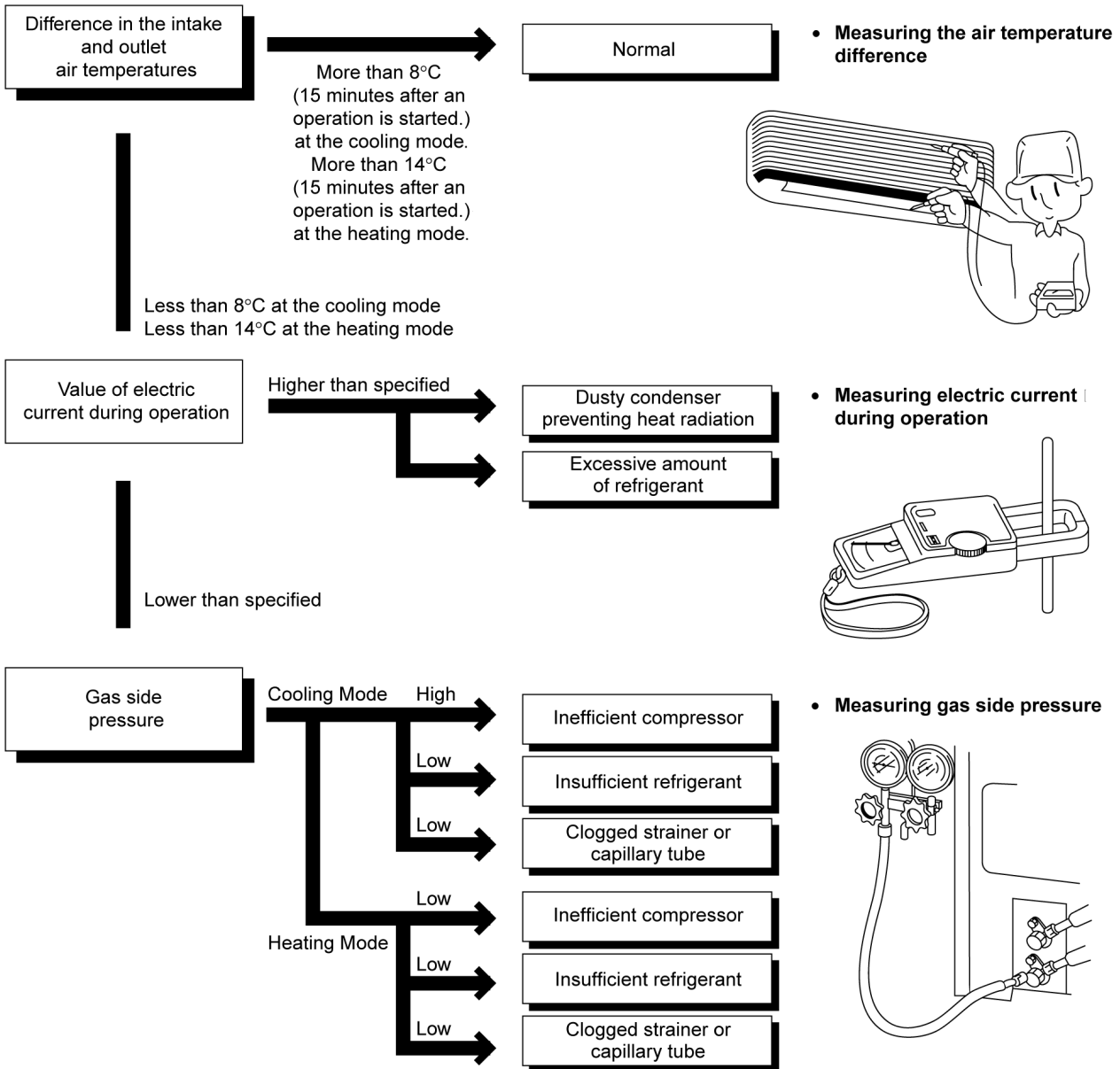

13.1.1. Relationship between the condition of the air conditioner and pressure and electric current

Condition of the air conditioner	Cooling Mode			Heating Mode		
	Low Pressure	High Pressure	Electric current during operation	Low Pressure	High Pressure	Electric current during operation
Insufficient refrigerant (gas leakage)	➔	➔	➔	➔	➔	➔
Clogged capillary tube or Strainer	➔	➔	➔	➔	➔	➔
Short circuit in the indoor unit	➔	➔	➔	➔	➔	➔
Heat radiation deficiency of the outdoor unit	➔	➔	➔	➔	➔	➔
Inefficient compression	➔	➔	➔	➔	➔	➔

- Carry out the measurements of pressure, electric current, and temperature fifteen minutes after an operation is started.

13.1.2. Diagnosis methods of a malfunction of a compressor and 4-way valve

Nature of fault	Symptom
Insufficient compressing of a compressor	<ul style="list-style-type: none"> • Electric current during operation becomes approximately 20% lower than the normal value. • The discharge tube of the compressor becomes abnormally hot (normally 70 to 90°C). • The difference between high pressure and low pressure becomes almost zero.
Locked compressor	<ul style="list-style-type: none"> • Electric current reaches a high level abnormally, and the value exceeds the limit of an ammeter. In some cases, a breaker turns off. • The compressor is a humming sound.
Insufficient switches of the 4-way valve	<ul style="list-style-type: none"> • Electric current during operation becomes approximately 80% lower than the normal value. • The temperature different between from the discharge tube to the 4-way valve and from suction tube to the 4-way valve becomes almost zero.

14 Technical Data

■ Thermostat characteristics

CS-W18CK / CS-W24CK

• Cooling

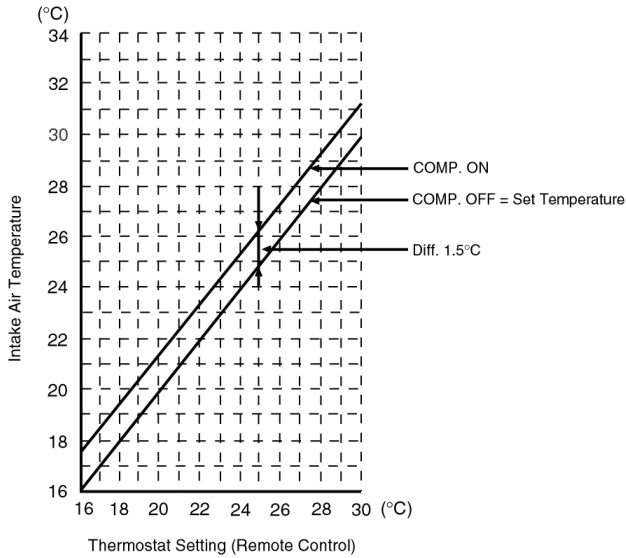

• Soft Dry

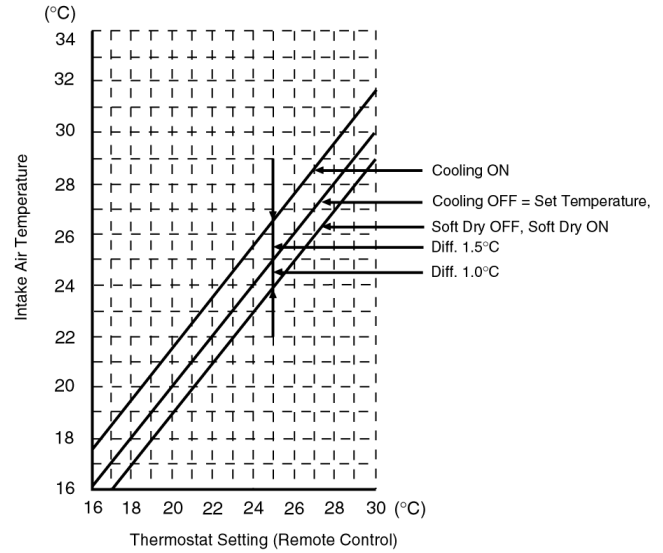

• Heating

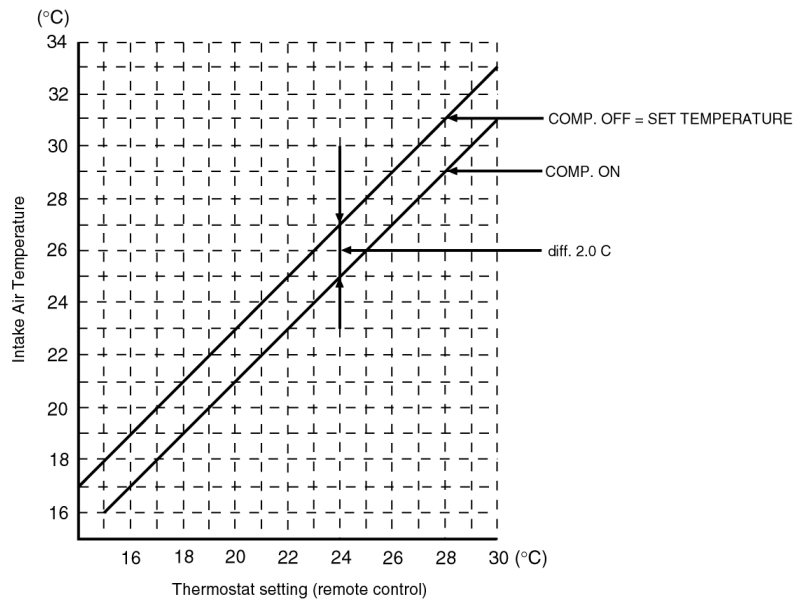

■ Sensible Capacity Chart

• CS-W18CK

230V Indoor wet bulb temp.	Outdoor Temp. (°C)											
	30			35			40			46		
	TC	SHC	IP	TC	SHC	IP	TC	SHC	IP	TC	SHC	IP
17.0°C	5.26	3.99	1.51	4.91	3.82	1.63	4.57	3.67	1.74	4.16	3.49	1.88
19.0°C				5.30		1.65						
19.5°C	5.77	4.17	1.54	5.40	4.01	1.66	5.02	3.86	1.77	4.56	3.67	1.91
22.0°C	6.29	4.33	1.57	5.88	4.16	1.69	5.47	4.01	1.80	4.97	3.83	1.95

• CS-W24CK

230V Indoor wet bulb temp.	Outdoor Temp. (°C)											
	30			35			40			46		
	TC	SHC	IP	TC	SHC	IP	TC	SHC	IP	TC	SHC	IP
17.0°C	6.97	5.29	2.55	6.52	5.07	2.74	6.06	4.87	2.93	5.51	4.63	3.16
19.0°C				7.03		2.78						
19.5°C	7.66	5.54	2.59	7.16	5.32	2.79	6.66	5.12	2.99	6.05	4.87	3.22
22.0°C	8.34	5.74	2.64	7.80	5.52	2.84	7.25	5.33	3.04	6.59	5.08	3.28

TC - Total Cooling Capacity (kW)
 SHC - Sensible Heat Capacity (kW)
 IP - Input Power (kW)

Indoor 27°C/19°C
 Outdoor 35°C/24°C

■ Operation characteristics

CS-W18CK / CU-W18CK

● Cooling Characteristic

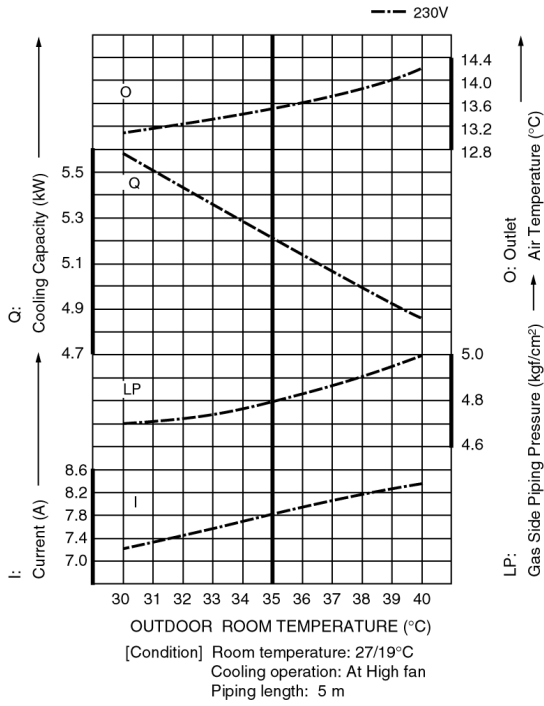

● Piping Length Characteristic (Cooling)

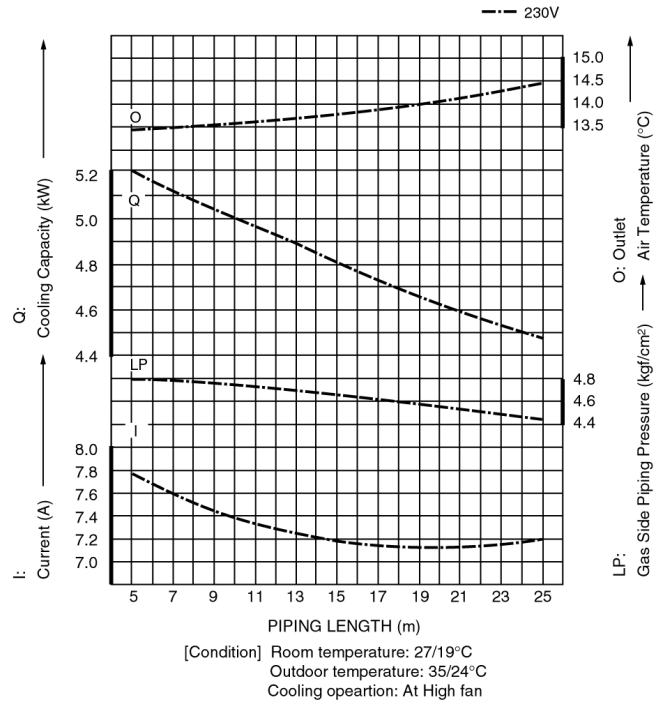

● Heating Characteristic

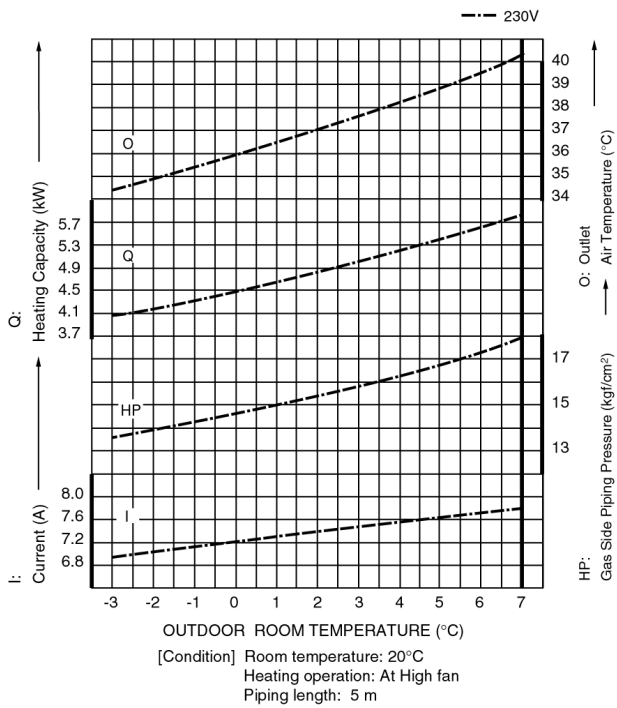

● Piping Length Characteristic (Heating)

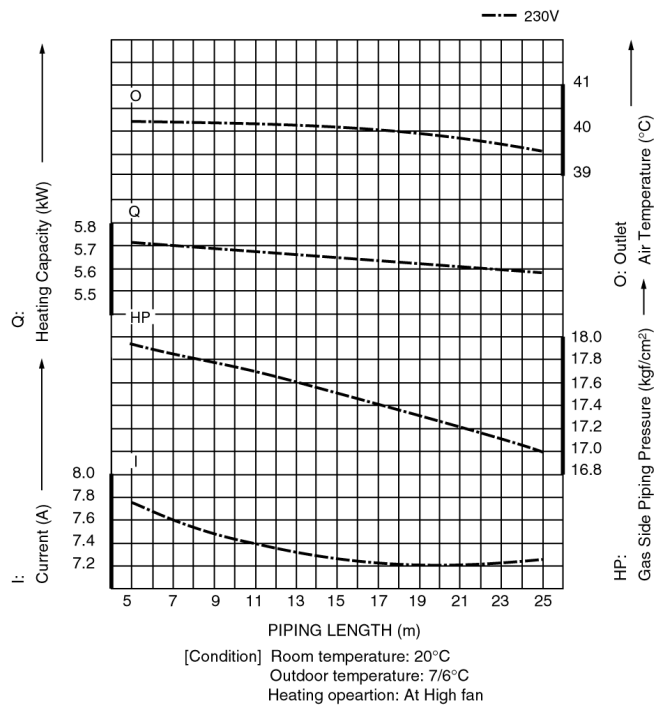

■ Operation characteristics

CS-W24CK / CU-W24CK

● Cooling Characteristic

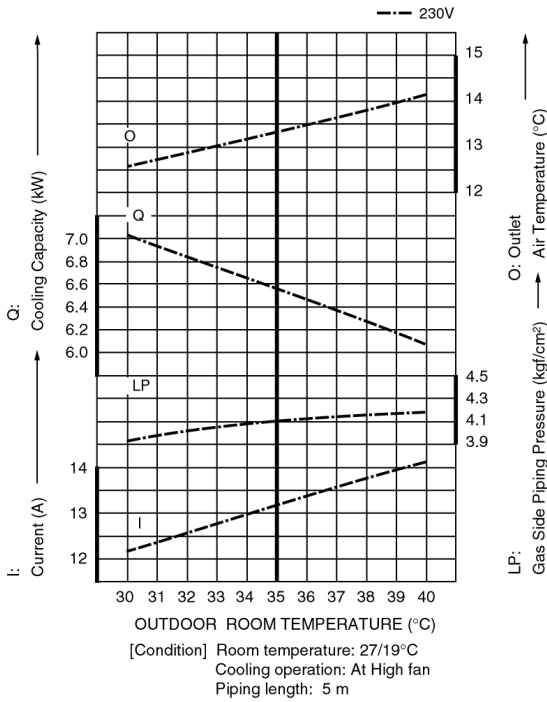

● Piping Length Characteristic (Cooling)

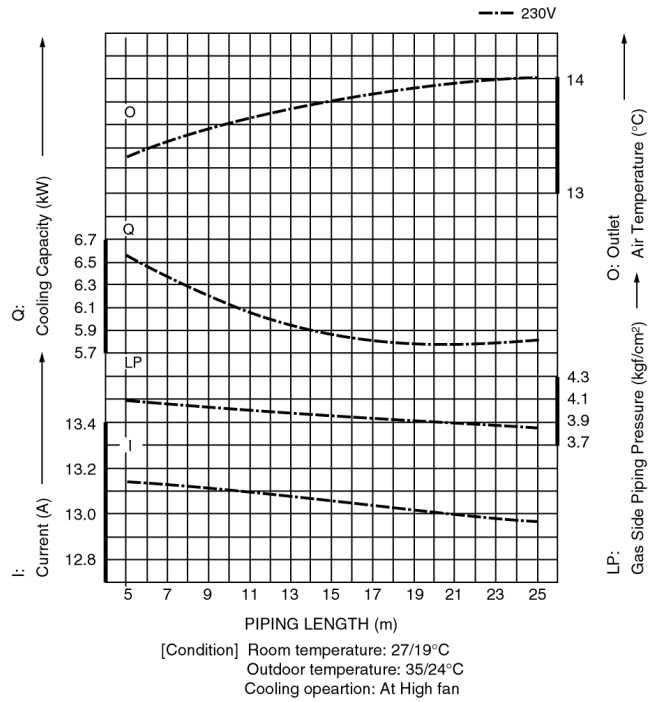

● Heating Characteristic

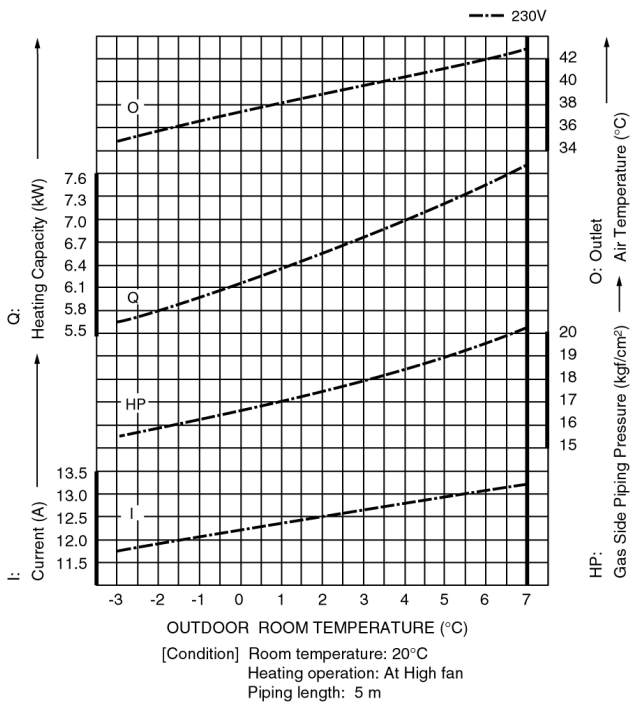

● Piping Length Characteristic (Heating)

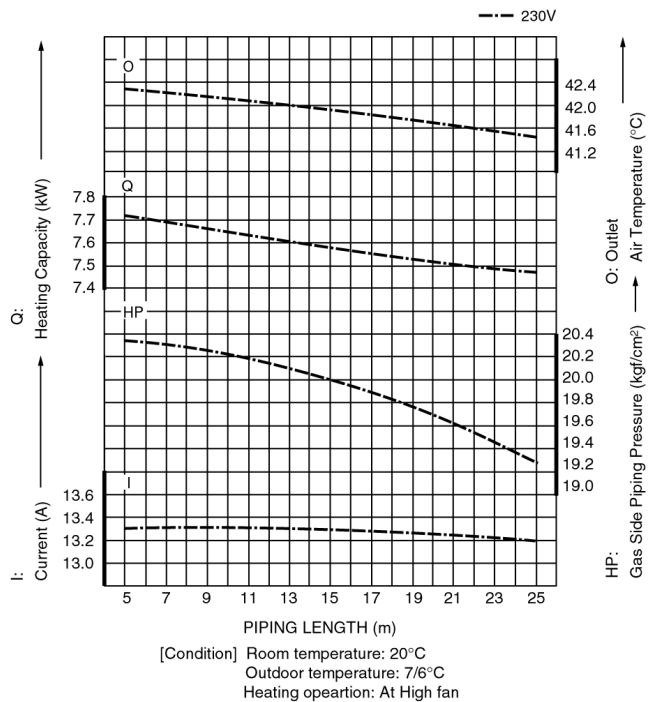

15 Exploded View

CS-W18CK / CS-W24CK

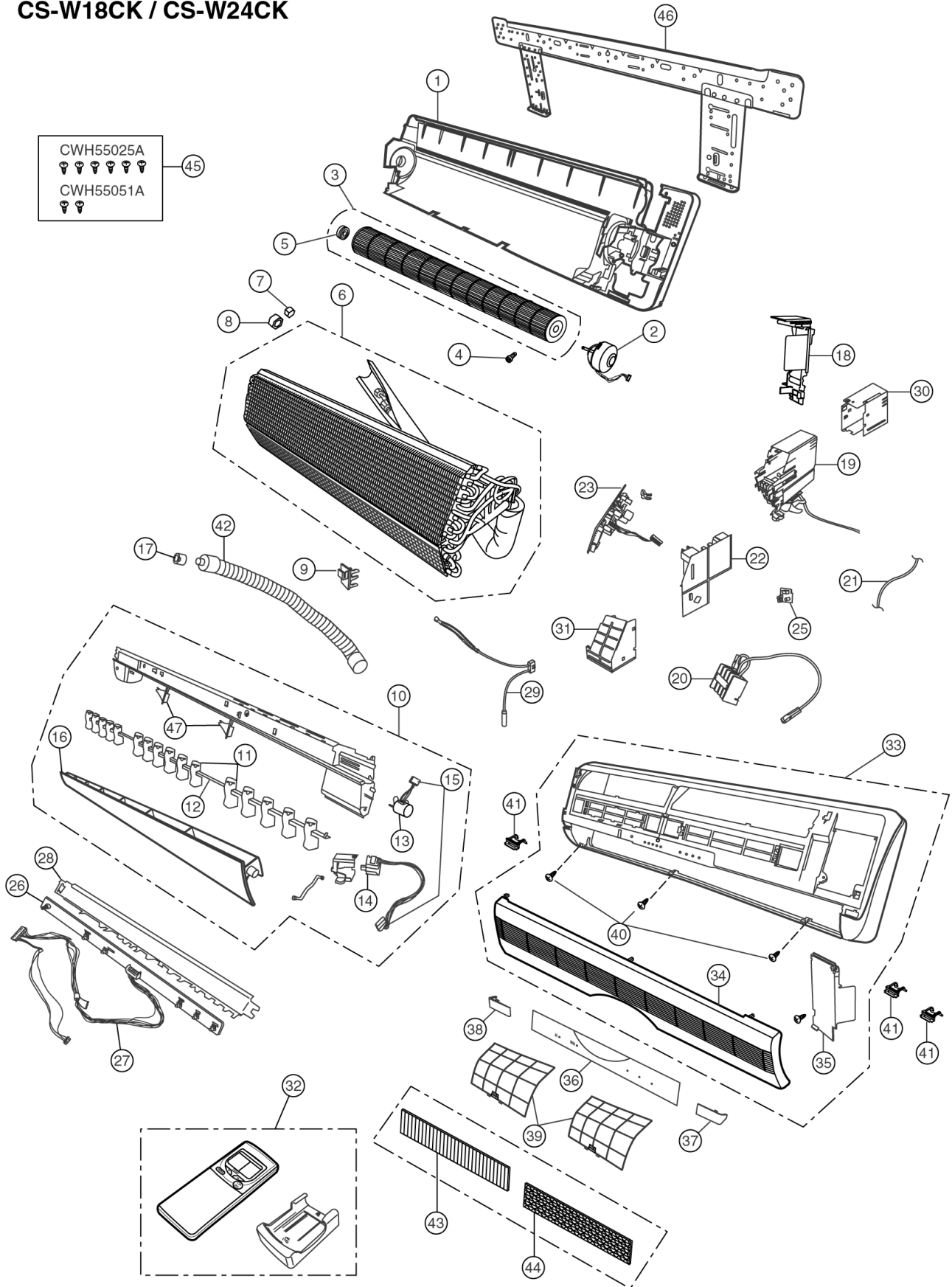

Note:
 The above exploded view is for the purpose of parts disassembly and replacement.
 The non-numbered parts are not kept as standard service parts.

16 Replacement Parts List

<Model: CS-W18CK / CS-W24CK>

REF. NO.	PART NAME & DESCRIPTION	QTY.	CS-W18CK	CS-W24CK	REMARKS
1	CHASSY COMPLETE	1	CWD50C1178	←	
2	FAN MOTOR	1	CWA981056	←	0
3	CROSS FLOW FAN COMPLETE	1	CWH02C1010	←	
4	SCREW - CROSS FLOW FAN	1	CWH4580304	←	
5	BEARING ASS'Y	1	CWH64K007	←	
6	EVAPORATOR	1	CWB30C1125	CWB30C1129	
7	FLARE NUT	1	CWH6002140 (1/4")	←	
8	FLARE NUT	1	CWT25007 (1/2")	CWT25004 (5/8")	
9	INTAKE AIR SENSOR HOLDER	1	CWH32142	←	
10	DISCHARGE GRILLE COMPLETE	1	CWE20C2102	←	
11	VERTICAL VANE	16	CWE241088	←	
12	CONNECTING BAR	1	CWE261025	←	
13	AIR SWING MOTOR	1	CWA98260	←	0
14	AIR SWING MOTOR	1	CWA981041	←	0
15	LEAD WIRE - AIR SWING MOTOR	1	CWA67C3731	←	
16	HORIZONTAL VANE	1	CWE241072	←	
17	CAP - DRAIN TRAY	1	CWH52C1001	←	
18	PARTICULAR PIECE	1	CWD932162	←	
19	CONTROL BOARD	1	CWH102103	←	
20	TERMINAL BOARD COMPLETE	1	CWA28C2095	CWA28C2070	0
21	POWER SUPPLY CORD	1	CWA20C2163	CWA20C2164	
22	ELECTRONIC CONTROLLER - MAIN	1	CWA742730	CWA742731	0
23	ELECTRONIC CONTROLLER - POWER	1	CWA742616	←	0
25	P.C.B. RECEIVER	1	CWA73C1124	←	
26	ELECTRONIC CONTROLLER - INDICATOR	1	CWE39C1046	←	0
27	LEAD WIRE - INDICATOR	1	CWA67C3724	←	
28	INDICATOR HOLDER	1	CWD932163	←	
29	SENSOR COMPLETE	1	CWA50C608	←	0
30	CONTROL BOARD TOP COVER	1	CWH131091	←	
31	CONTROL BOARD FRONT COVER	1	CWH131090	←	
32	REMOTE CONTROL COMPLETE	1	CWA75C2189	←	0
33	FRONT GRILLE COMPLETE	1	CWE11C2330	←	
34	INTAKE GRILLE	1	CWE221037	←	
35	GRILLE DOOR	1	CWE141033	←	
36	CONTROL PANEL	1	CWE312114	←	
37	DECORATION BASE (R)	1	CWE351067	←	
38	DECORATION BASE (L)	1	CWE351068	←	
39	AIR FILTER	2	CWD001049	←	
40	SCREW - FRONT GRILLE	3	XTT4+16C	←	
41	CAP - FRONT GRILLE	3	CWH521062	←	
42	DRAIN HOSE	1	CWH851044	←	
43	AIR PURIFYING FILTER	1	CWMD00C0001	←	0
44	SOLAR DEODORIZING FILTER	1	CWMD00C0002	←	0
45	BAG COMPLETE - INSTALLATION SCREW	1	CWH82C067	←	
46	INSTALLATION PLATE	1	CWH36K1007	←	
47	FULCRUM	2	CWH621013	←	

(Note)

- All parts are supplied from MAICO, Malaysia (Vendor Code: 061).
- "O" marked parts are recommended to be kept in stock.

18 Replacement Parts List

<Model: CU-W18CK / CU-W24CK>

REF. NO.	PART NAME & DESCRIPTION	QTY.	CU-W18CK	CU-W24CK	REMARKS
1	CHASSY ASS'Y	1	CWD50K515B	CWD50K514B	
2	SOUND PROOF BOARD	1	CWH15223	←	
3	FAN MOTOR BRACKET	1	CWD54237	←	
4	SCREW - FAN MOTOR BRACKET	4	CWH55027	←	
5	FAN MOTOR	1	CWA921182	CWA921081	0
6	SCREW - FAN MOTOR MOUNT	4	CWH55252	←	
7	PROPELLER FAN ASS'Y	1	CWH00K087	CWH00K1001	
8	NUT - PROPELLER FAN	1	CWH56053	CWH56060	
9	COMPRESSOR	1	5KS205DAA	5JS315DAA	0
10	PACKING	1	CWB81043	←	
11	ANTI - VIBRATION BUSHING	3	CWH50055	←	
12	NUT - COMPRESSOR MOUNT	3	CWH4582065	←	
13	SOUND PROOF MATERIAL	1	CWG30894	←	
14	CONDENSER	1	CWB32C1298	CWB32C1300	
15	HOLDER COUPLING ASS'Y	1	CWH35K029B	CWH35K030B	
16	3-WAY VALVE (LIQUID)	1	CWB011078	←	0
17	3-WAY VALVE (GAS)	1	CWB011156	←	0
18	4-WAY VALVE ASS'Y	1	CWB00K1011	CWB00K1012	0
19	TUBE ASS'Y (CAPILLARY TUBE & STRAINER)	1	CWT01C2399	CWT01C2444	
20	V-COIL COMPLETE	1	CWA43C2121	←	0
21	TERMINAL COVER	1	CWH171012	←	
22	NUT - TERMINAL COVER	1	CWH7080300	←	
23	CONTROL BOARD	1	CWH10K1019	←	
24	CAPACITOR - FAN MOTOR	1	FOGAH305A002	←	0
25	CAPACITOR - COMPRESSOR	1	DS371506CPNA	DS371456CPNA	0
26	HOLDER CAPACITOR	1	CWH30060	←	
27	TERMINAL BOARD ASS'Y	1	CWA28K216	←	
28	ELECTRONIC CONTROLLER	1	CWA743072	←	
30	SENSOR COMPLETE	1	CWA50C618	←	
31	HOLDER - SENSOR	1	CWH32089	←	
32	CABINET FRONT PLATE	1	CWE06K034B	←	
33	CABINET REAR PLATE	1	CWE02096B	←	
34	CABINET FRONT PLATE	1	CWE06075B	←	
35	CABINET SIDE PLATE	1	CWE04111B	←	
36	CABINET TOP PLATE	1	CWE03101B	←	
37	CONTROL BOARD COVER	1	CWH13336A	←	
38	HANDLE	2	CWE16000E	←	
39	OPERATION INSTRUCTIONS	1	CWF563837	←	
40	INSTALLATION INSTRUCTIONS (ENGLISH, FRANCAIS, ESPANOL & DEUTSCH)	1	CWF612190	←	
41	INSTALLATION INSTRUCTIONS (ITALIANO, NEDERLANDS, PORTUGUES & GREEK)	1	CWF612222	←	
42	INSTALLATION INSTRUCTIONS (RUSSIA)	1	CWF612223	←	
43	PARTICULATE PLATE	1	CWD90830	←	
44	L-TUBE	1	CWH5850080	←	
45	DRYER	1	CWB101002	←	

(Note)

- All parts are supplied from MAICO, Malaysia (Vendor Code: 061).
- "O" marked parts are recommended to be kept in stock.

19 Electronic Circuit Diagram

- CS-W18CK / CU-W18CK
- CS-W24CK / CU-W24CK

SCHEMATIC DIAGRAM 1/3

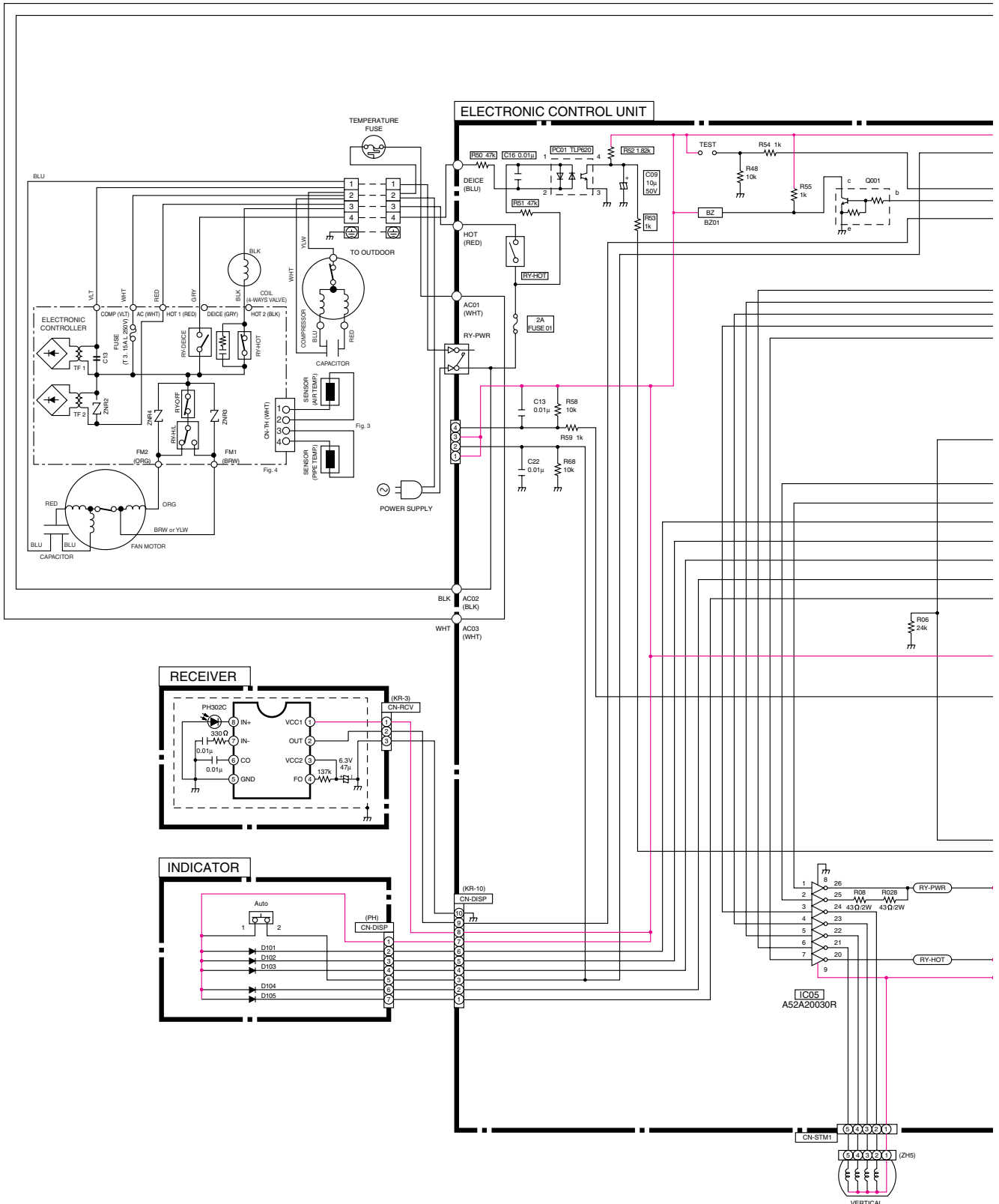

SCHEMATIC DIAGRAM 2/3

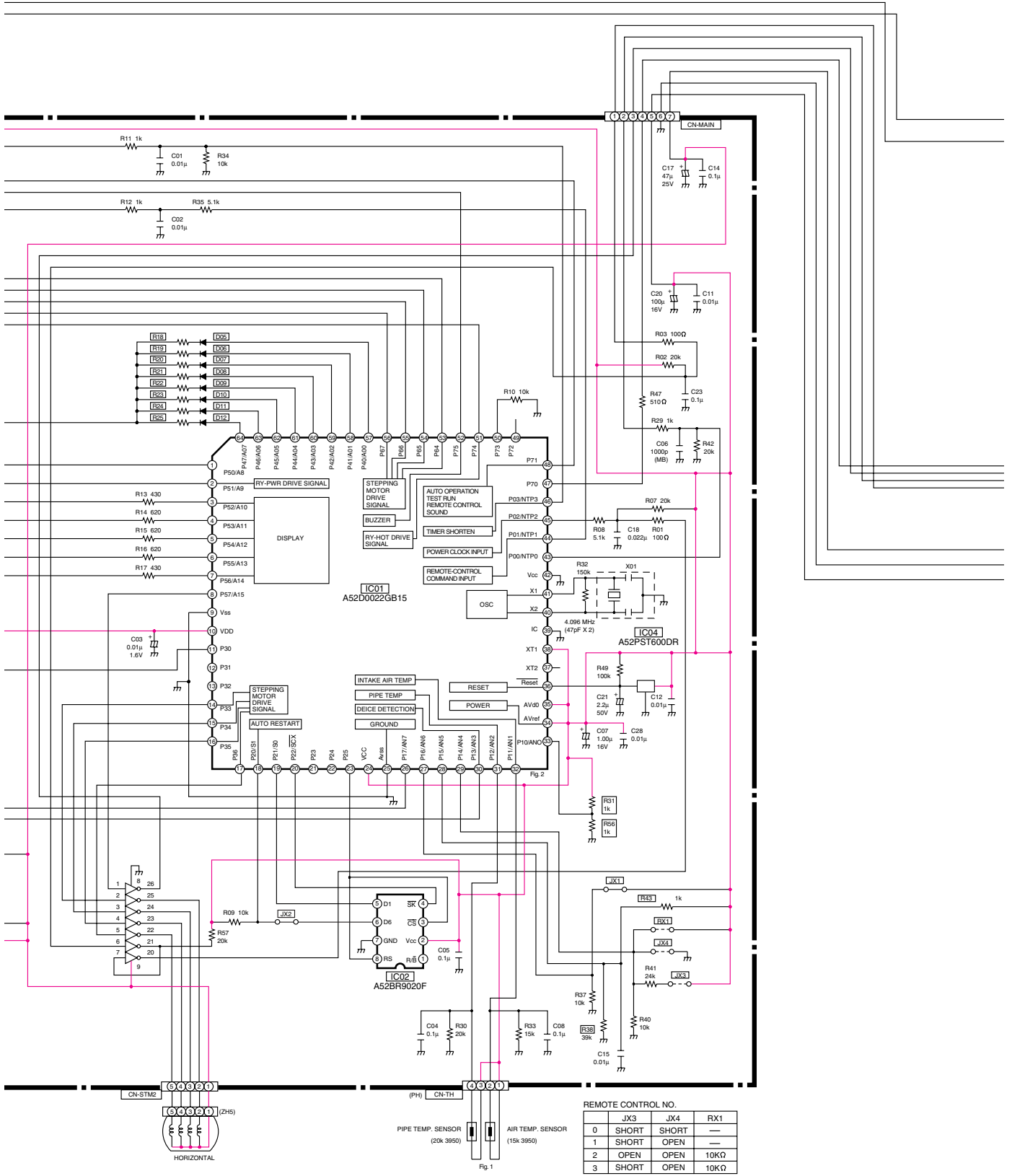

REMOTE CONTROL NO.

	JX3	JX4	RX1
0	SHORT	SHORT	—
1	SHORT	OPEN	—
2	OPEN	OPEN	10KΩ
3	SHORT	OPEN	10KΩ

SCHEMATIC DIAGRAM 3/3

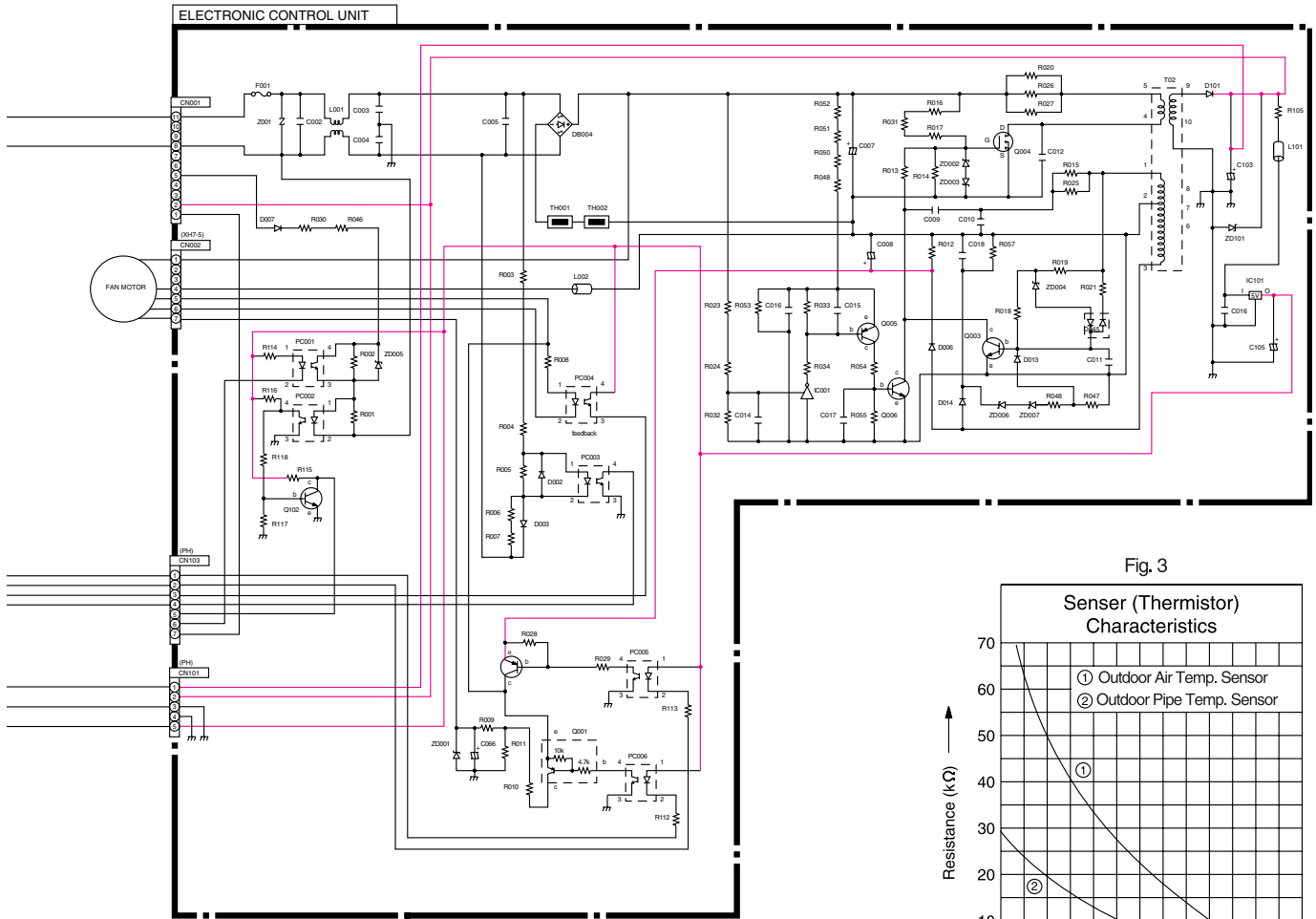

Fig. 3

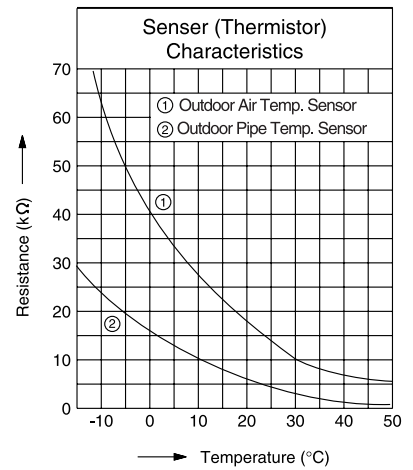

Fig. 1

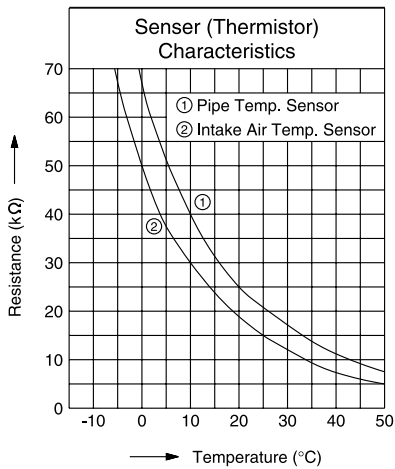

Fig. 2

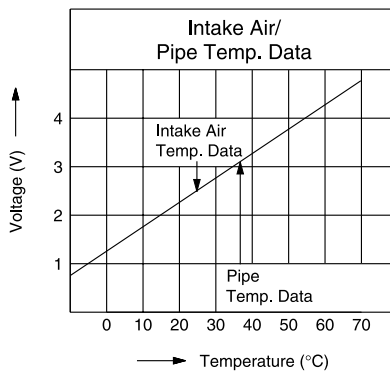
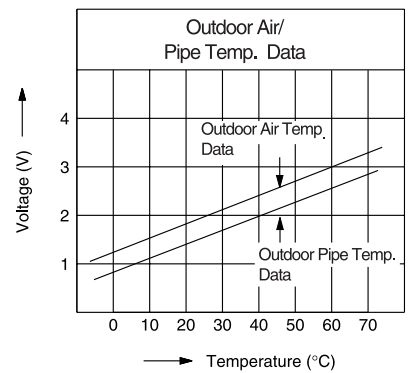

Fig. 4



How to use electronic circuit diagram

Before using the circuit diagram, read the following carefully.

* Voltage measurement

Voltage has been measured with a digital tester when the indoor fan is set at high fan speed under the following conditions without setting the timer.

Use them for servicing.

Voltage indication is in Red at all operations.

	Intake air temperature	Temperature setting	Discharge air temperature	Pipe temperature
Cooling	27°C	16°C	17°C	15°C
Heating	20°C	30°C	40°C	50°C

* Indications for resistance

a. K...kΩ M...MΩ
W...watt Not indicated....1/4W

b. Type

Not indicated.....carbon resistor

Tolerance±5%



.....metal oxide resistor

Tolerance±1%

* Indications for capacitor

a. Unit μ...μF P...pF

b. Type Not indicated....ceramic capacitor

(S).....S series aluminium

electrolytic capacitor

(Z).....Z series aluminium

electrolytic capacitor

(SU).....SU series aluminium

electrolytic capacitor

(P).....P series polyester system

(SXE).....SXE series aluminium

electrolytic capacitor

(SRA).....SRA series aluminium

electrolytic capacitor

(KME).....KME series aluminium

electrolytic capacitor

* Diode without indication.....MA165

※ Circuit Diagram is subject to change without notice for further development.

TIMER TABLE

Name	Time	Test Mode (When test point Short-circuited)	Remarks
Sleep Mode Waiting	1 hr.	6 sec.	
Sleep Mode Operation	8 hrs.	48 sec.	
Real Timer	1 hr.	1 min.	
	10 min.	10 sec.	
	1 min.	1 sec.	
Time Delay Safety Control	2 min. 58 sec.	0 sec.	
Forced Operation	60 sec.	0 sec.	
Time Save Control	7 min.	42 sec.	
Anti-Freezing	4 min.	0 sec.	
Auto Mode Judgement	25 sec.	0 sec.	
Soft Dry	OFF	6 min.	36 sec.
	ON	10 min.	60 sec.
Deodorizing Control	Cooling	40 sec.	4 sec.
		70 sec.	7 sec.
		20 sec.	2 sec.
		180 sec.	18 sec.
	Soft Dry	40 sec.	4 sec.
		360 sec.	36 sec.
Comp. Reverse Rotation Detection	5 min.	30 sec.	Comp. ON 5 min. and above
	2 min.	0 sec.	
Comp./ Fan Motor Delay Timer	1.6 sec.	0 sec.	
Powerful Mode Operation	15 min.	15 sec.	
Random Auto Restart Control	0 ~ 62 sec.	0 ~ 6.2 sec.	
4 Way Valve	5 min.	30 sec.	
After Deice Ended	30 sec.	3 sec.	Comp. OFF after deice
Hotstart Delay Times	4 min.	0 sec.	
Hotstart Finish Times	2 min.	0 sec.	

19.1. REMOTE CONTROL

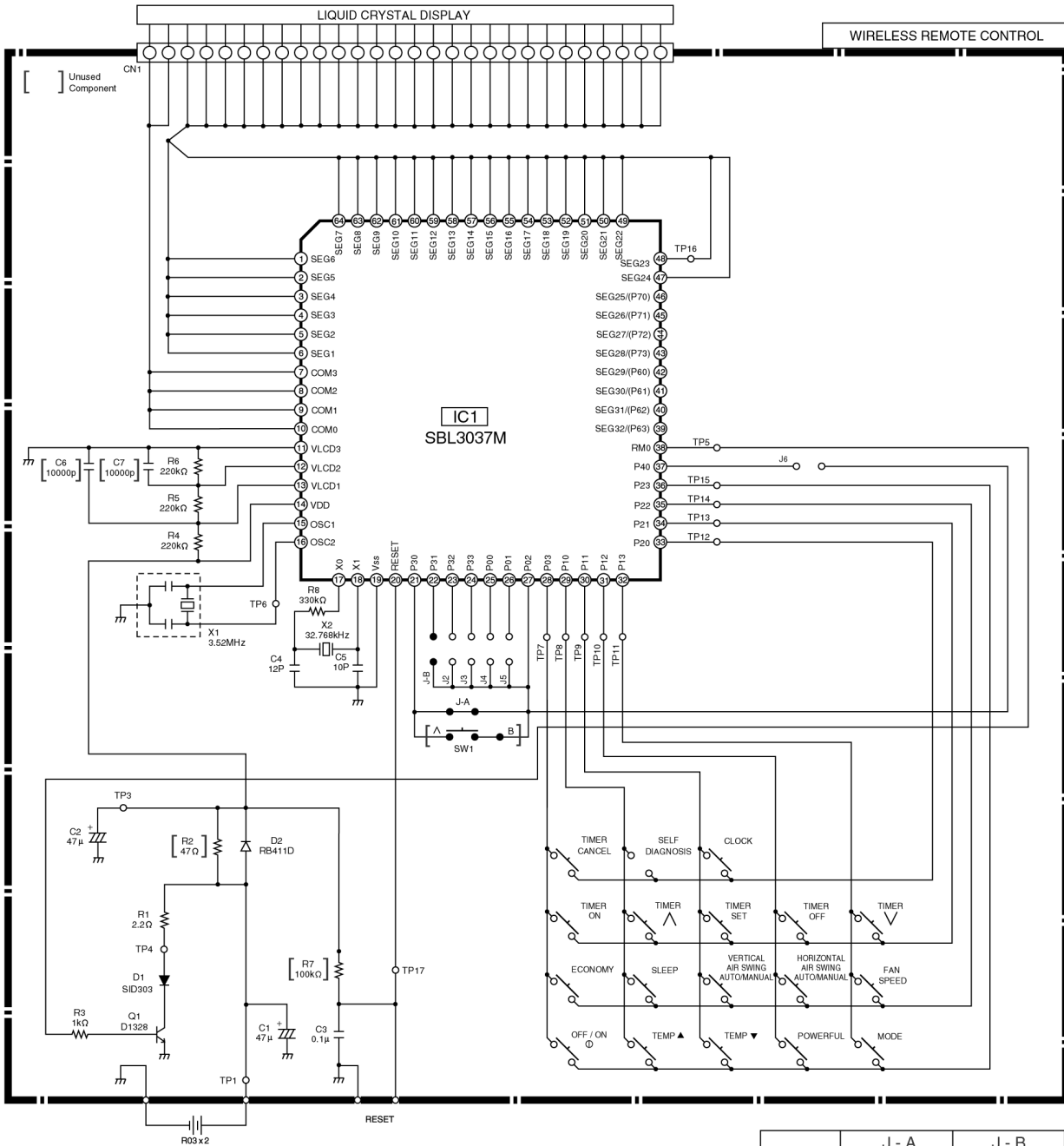

	J - A	J - B
0	SHORT	OPEN
1	OPEN	OPEN
2	SHORT	SHORT
3	OPEN	SHORT

19.2. PRINT PATTERN INDOOR UNIT PRINTED CIRCUIT BOARD

TOP VIEW

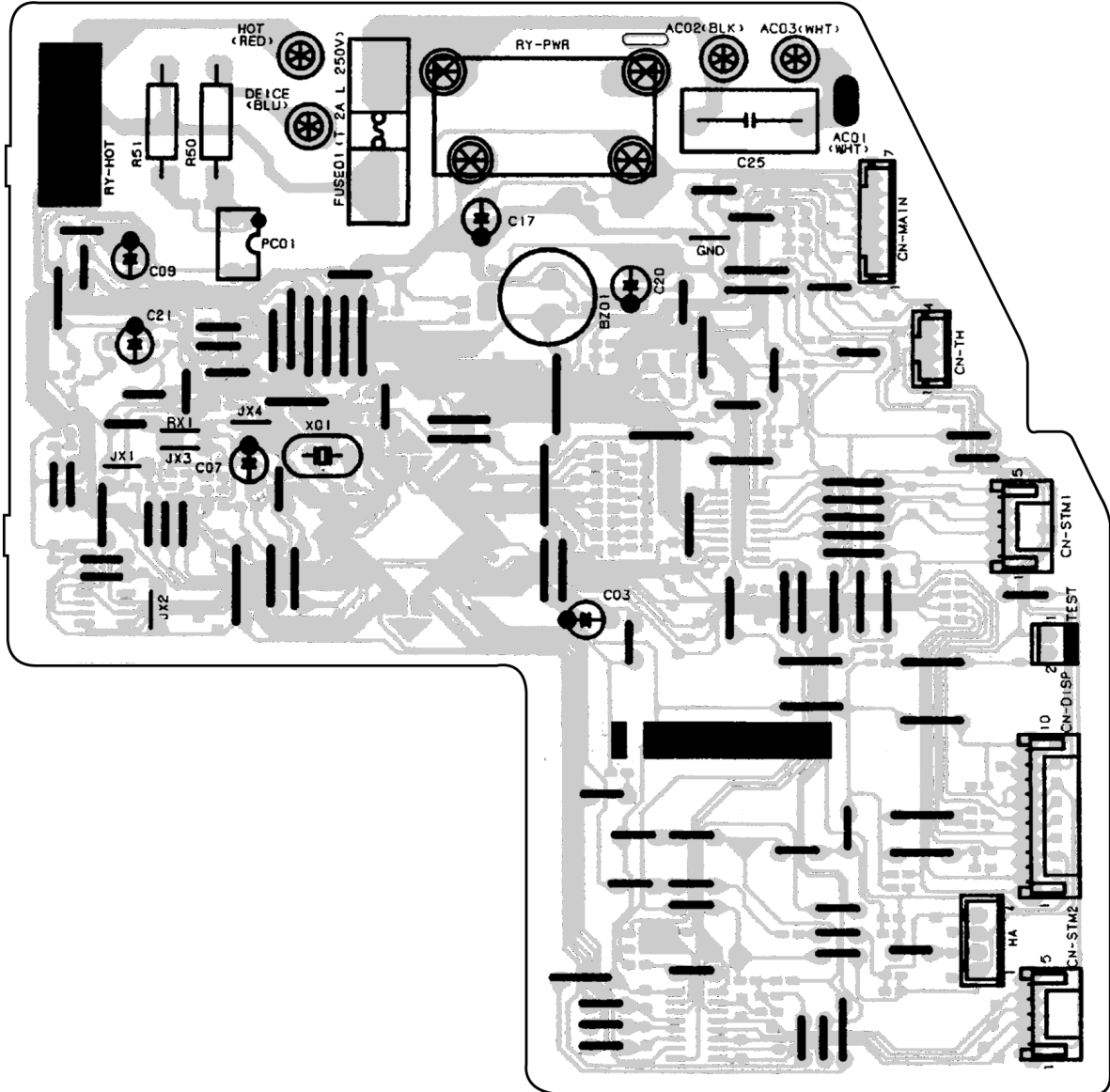

19.3. PRINT PATTERN INDOOR UNIT PRINTED CIRCUIT BOARD

BOTTOM VIEW

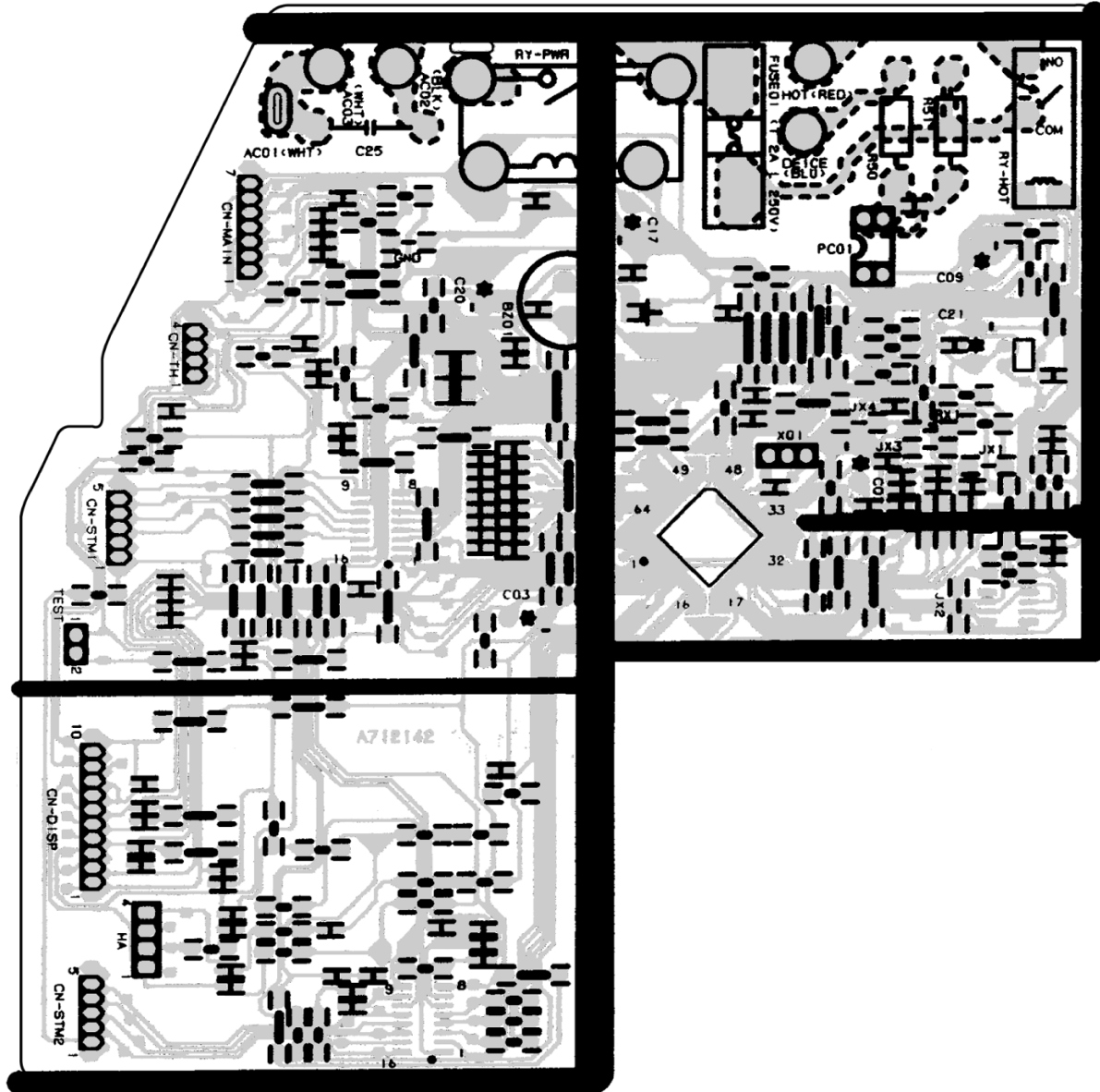

19.4. PRINT PATTERN OUTDOOR UNIT PRINTED CIRCUIT BOARD

