

TECHNICAL DATA & SERVICE MANUAL



INDOOR UNIT: FCIAS8

SPLIT SYSTEM AIR CONDITIONER

Model No.	Product Code No.
FCIAS8	387005002

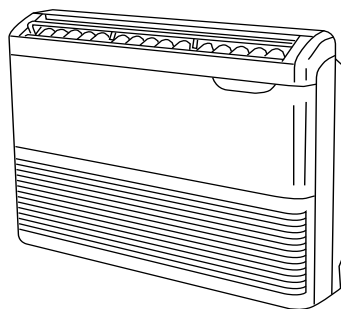
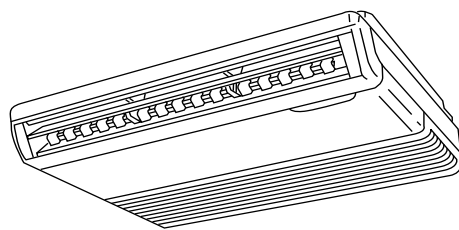

IMPORTANT! Please read before installation

This air conditioning system meets strict safety and operating standards.

For the installer or service person, it is important to install or service the system so that it operates safely and efficiently.

For safe installation and trouble-free operation, you must:

- Carefully read this instruction booklet before beginning.
- Follow each installation or repair step exactly as shown.
- Observe all local, state and national electrical codes.
- Pay close attention to all warning and caution notices given in this manual.
- The unit must be supplied with a dedicated electrical line.



WARNING

This symbol refers to a hazard or unsafe practice which can result in severe personal injury or death.



CAUTION

This symbol refers to a hazard or unsafe practice which can result in personal injury or product or property damage.

If necessary, get help

These instructions are all you need for most installation sites and maintenance conditions.

If you require help for a special problem, contact our sale/service outlet or your certified dealer for additional instructions.

In case of improper installation

The manufacturer shall in no way be responsible for improper installation or maintenance service, including failure to follow the instructions in this document.

SPECIAL PRECAUTIONS

- During installation, connect before the refrigerant system and then the wiring one; proceed in the reverse order when removing the units.

WARNING

When wiring



ELECTRICAL SHOCK CAN CAUSE SEVERE PERSONAL INJURY OR DEATH. ONLY QUALIFIED, EXPERIENCED ELECTRICIANS SHOULD ATTEMPT TO WIRE THIS SYSTEM.

- Do not supply power to the unit until all wiring and tubing are completed or reconnected and checked, to ensure the grounding.
- Highly dangerous electrical voltages are used in this system. Carefully refer to the wiring diagram and these instructions when wiring.
Improper connections and inadequate grounding can cause **accidental injury and death.**

- **Ground the unit** following local electrical codes.
- The Yellow/Green wire cannot be used for any connection different from the ground connection.
- Connect all wiring tightly. Loose wiring may cause overheating at connection points and a possible fire hazard.
- Do not allow wiring to touch the refrigerant tubing, compressor, or any moving parts of the fan.
- Do not use multi-core cable when wiring the power supply and control lines. Use separate cables for each type of line.

When transporting

Be careful when picking up and moving the indoor and outdoor units. Get a partner to help, and bend your knees when lifting to reduce strain on your back. Sharp edges or thin aluminium fins on the air conditioner can cut your fingers.

When installing...

... In a ceiling

Make sure the ceiling is strong enough to hold the unit-weight. It may be necessary to build a strong wooden or metal frame to provide added support.

... In a room

Properly insulate any tubing run inside a room to prevent "sweating", which can cause dripping and water damage to walls and floors.

... In moist or uneven locations

Use a raised concrete base to provide a solid level foundation for the outdoor unit. This prevents damage and abnormal vibrations.

... In area with strong winds

Securely anchor the outdoor unit down with bolts and a metal frame. Provide a suitable air baffle.

... In a snowy area (for heat pump-type systems)

Install the outdoor unit on a raised platform that is higher than drifting snow. Provide snow vents.

When connecting refrigerant tubing

- Keep all tubing runs as short as possible.
- Use the flare method for connecting tubing.
- Apply refrigerant lubricant to the matching surfaces of the flare and union tubes before connecting them; screw by hand and then tighten the nut with a torque wrench for a leak-free connection.
- Check carefully for leaks before starting the test run.

NOTE:

Depending on the system type, liquid and gas lines may be either narrow or wide. Therefore, to avoid confusion, the refrigerant tubing for your particular model is specified as narrow tube for liquid, wide tube for gas.

When servicing

- Turn the power OFF at the main power board before opening the unit to check or repair electrical parts and wiring.
- Keep your fingers and clothing away from any moving parts.
- Clean up the site after the work, remembering to check that no metal scraps or bits of wiring have been left inside the unit being serviced.
- Ventilate the room during the installation or testing the refrigeration system; make sure that, after the installation, no gas leaks are present, because this could produce toxic gas and dangerous if in contact with flames or heat-sources.

Table of Contents

	Page
1. SPECIFICATIONS	4
1-1 Unit specifications	4
1-2 Major Component specifications	5
1-3 Other Component specifications	6
2. DIMENSIONAL DATA	7
3. PERFORMANCE DATA	8
3-1 Air Throw Distance Chart	8
4. ELECTRICAL DATA	9
4-1 Electric Wiring Diagrams	9
5. FUNCTION	10
5-1 System operation control	10,
5-2 Cool Mode Operation	11
5-3 Heat Mode Operation	11
5-4 Auto Mode Operation (only monosplit)	12
5-5 Dry Mode Operation	13
5-6 Fan Mode Operation	13
5-7 Auto Fan Speed	13
5-8 Forced-Made	14
5-9 Protection Operations in indoor unit	14
5-10 Protection Operation outdoor unit	15
5-11 Defrost	16
5-12 I Feel Function	16
5-13 Hi Power mode	16
5-14 Night Function	17
5-15 Leds off function	17
5-16 Capacity Test Mode	17
5-17 Diagnostic	18
5-18 Indoor unit jumpers Configuration	19
5-19 Outdoor unit jumpers Configuration	19
5-20 Contacts for building automation	19
6. INDOOR UNIT AND REMOTE CONTROL ADDRESS	20
6-1 Address Switches (only for multisplit)	20
6-2 Refrigerant Circuit Check (only for multisplit)	20
6-3 Changing the Address of the Air Conditioner	20
7. TROUBLESHOOTING	21
7-1 Check before and after troubleshooting	21
7-2 Circuit Breaker Trips or Fuse Blows	21
7-3 System does not run	22
7-4 Outdoor Unit does not run and no Fault is displayed	24
7-5 Only Outdoor Unit is Off	24
7-6 Fault on outdoor unit	25
7-7 Air Conditioner operates, but abnormalities are observed	26
7-8 Noise problem	28
8. CHECKING ELETRICAL COMPONENTS	29
8-1 Measurement of Insulation Resistance	29
8-2 Checking Continuity of Fuse on PCB Assy	29
8-3 Checking motor capacitor	29

1. SPECIFICATIONS

1-1 Unit Specifications

FCIAS8

Power source	220 - 240V ~ 50Hz
---------------------	-------------------

Voltage rating	230 V - 50 Hz
-----------------------	---------------

Performance		See catalogue with the requested matching
Capacity		
Air circulation	High/Med./Low	m ³ /h
		520/430/390

Features		
Controls/Temperature controls		Microprocessor/ I.C. thermostat
Control unit		Wireless remote control unit
Timer		ON/OFF 24 hours & Daily program, 1-hour OFF
Fan speed		3 and Auto
Airflow direction		Auto (Remote control)
Air Filter		Washable, easy acces, long life (2500 hr.)
Power noise level	High/Med./Low	dB-A
		43/35/28
Refrigerant tubing connections		Flare type
Refrigerant tube diameter	Narrow tube	mm(in.)
	Wide tube	mm(in.)
		6,35 (1/4)
		9,52 (3/8)
Refrigerant		R410A

Dimensions & Weight		
Unit dimensions	Height	mm
	Width	mm
	Depth	mm
Package dimensions	Height	mm
	Width	mm
	Depth	mm
Weight	Net	kg
	Shipping	kg
Shipping volume		m ³

DATA SUBJECT TO CHANGE WITHOUT NOTICE

1-2 Major Component Specifications

FCIAS8

Controller PCB	
Part No.	SAC DCI IDU
Controls	Microprocessor
Control circuit fuse	250 V - 3,15 A

Remote Control Unit	SAC W-REM V3
---------------------	--------------

Fan & Fan Motor	
Type	Centrifugal fan
Q'ty Dia. and length	2.... Ø 130 / L 180
Fan motor model...Q'ty	K35406-M02046... 1
No. of poles...rpm (230 V, High)	4...1040
Nominal output	W 9
Running Amps	A 0,17
Power input	W 37
Coil resistance (Ambient temp. 25 °C)	Ω GRY-WHT: 605 WHT-PNK: 151 WHT-VLT: 130 VLT-ORG: 67 ORG-YEL: 150
Safety devices	Type Thermal protection
	Operating temp. Open °C 150 ± 5
	Close Automatic reclosing
Run capacitor	μF 1,2
	VAC 440

Flap Motor	
Type	Stepping motor
Model	MP24Z2
Rating	DC 12 V
Coil resistance (Ambient temp. 25 °C)	Ω 400 ± 7%

Heat Exch. Coil	
Coil	Aluminium plate fin / Copper tube
Rows	2
Fin pitch	mm 1,8
face area	m ² 0,192

DATA SUBJECT TO CHANGE WITHOUT NOTICE

1-3 Other Component Specifications

Thermistor (Coil sensor TH1)		
Resistance	k Ω	10 \pm 3%
Thermistor (Room sensor)		NTC-THERMISTOR
Resistance	k Ω	10 at 25 °C

2. DIMENSIONAL DATA

FCIAS8

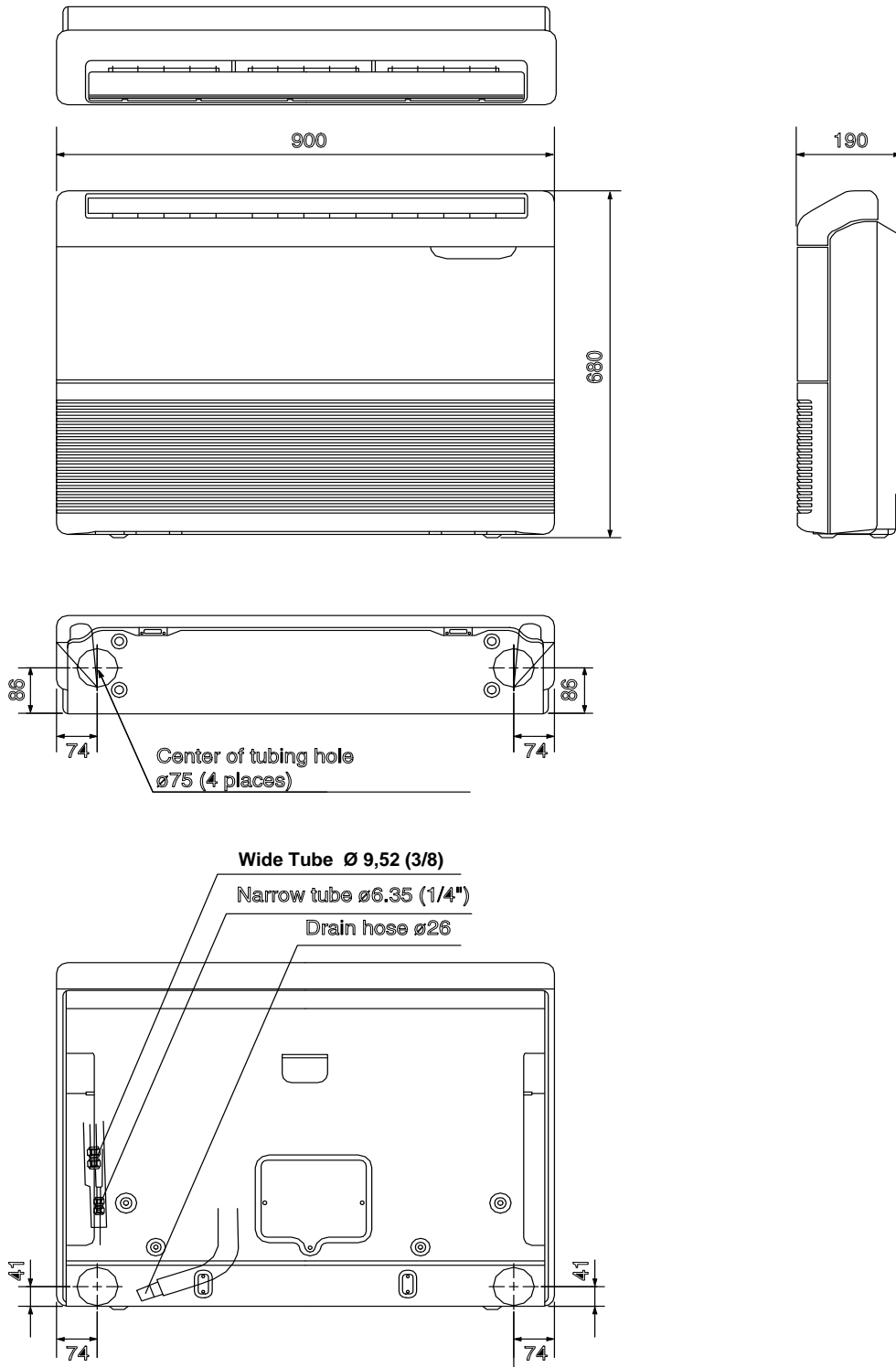

Units: mm

3. PERFORMANCE DATA

3-1 Air Throw Distance Chart

FCIAS8

Floor Mounted

Cooling

Room air temp. : 27°C
Fan speed : High

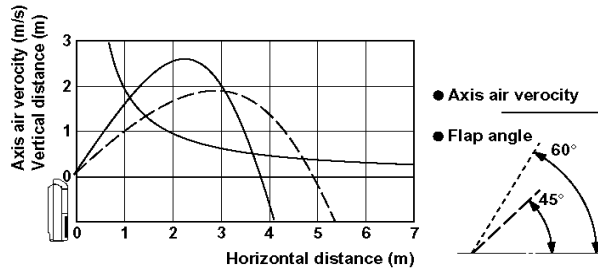

Heating

Room air temp. : 20°C
Fan speed : High

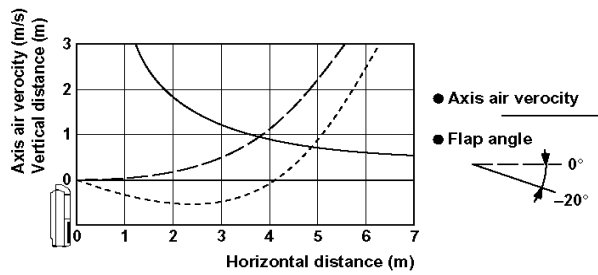

Ceiling Mounted

Cooling

Room air temp. : 27°C
Fan speed : High

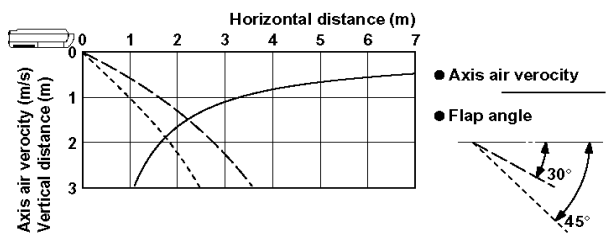

Heating

Room air temp. : 20°C
Fan speed : High

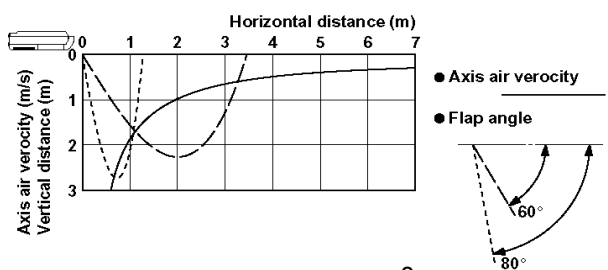

4. ELECTRICAL DATA

4-1 Electric Wiring Diagram

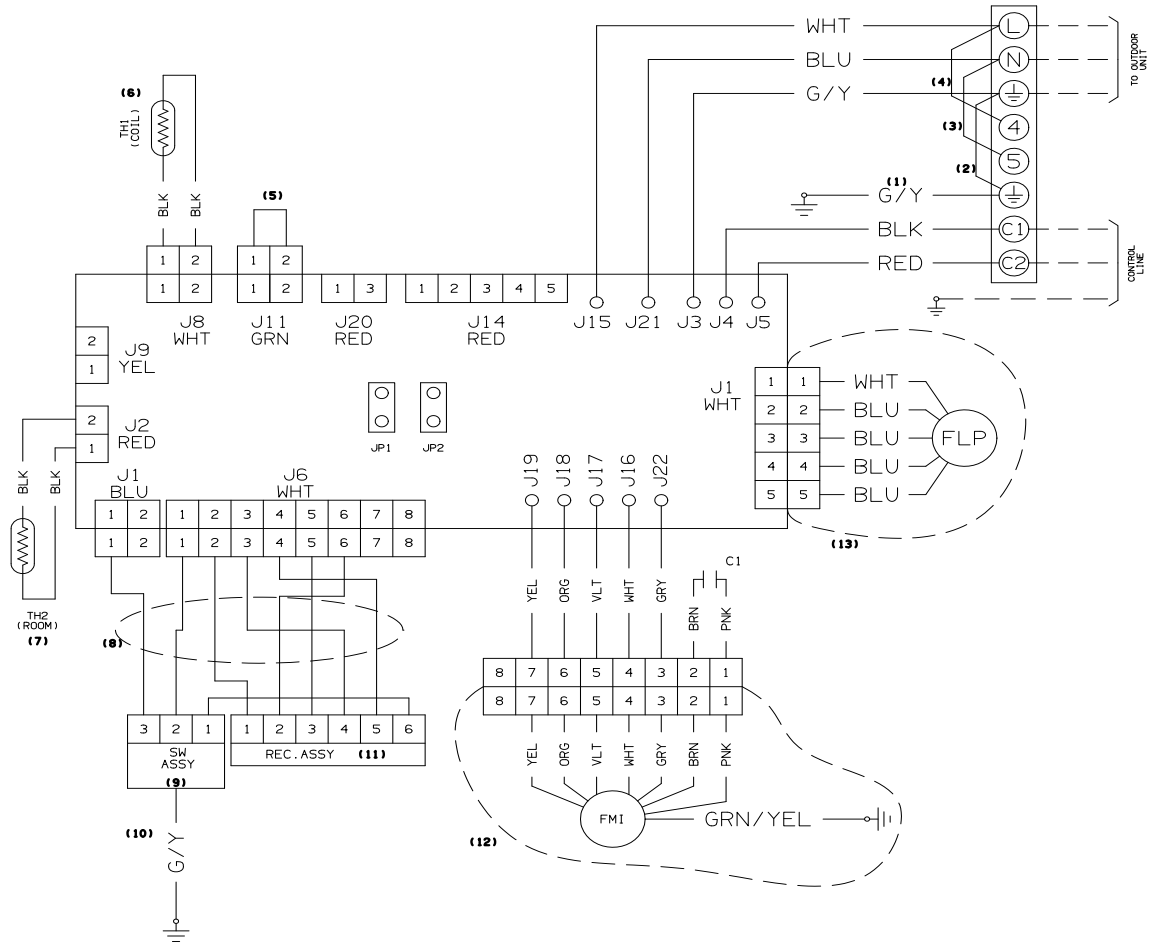

5.FUNCTION

5-1 System operation control

The inputs to the systems come from indoor and outdoor sensors. The outdoor unit is the system MASTER while the indoor one is the SLAVE.
Communication between units is made with a 2 poles RS485 bus

The indoor units receives the user input (fan speed, flap position etc) through remote controller which sends signal every time a button is pressed and in any case, automatically, every 5 minutes.

5.1.1 control specification

During operation compressor speed can be subjected to change due to thermal load variations or protection activations but in any case:

- The minimum time interval between an OFF and a ON operation is not lower than 3 minutes
- The minimum operating time is not lower than 3 minutes
- The maximum acceleration/deceleration rate is fixed at 50rpm /sec
- During the start-up compressor speed increases according to a defined rule which is independent from the thermal load calculation.

5-1.2 Multisplit available modes

If the unit is a part of a multisplit system, there could be some mode combination not available (example: unit A - heat mode and unit B - cool mode).
In this case the system automatically stops, leds TMR and STB blink while led OPR is on

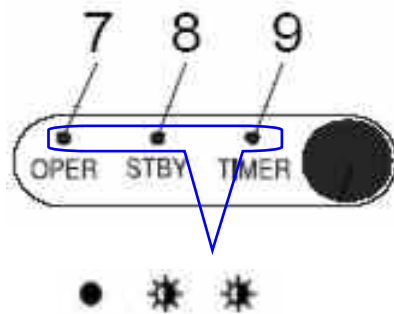

★ = LED blinking
● = LED on

AVAILABLE MODE COMBINATION TABLE

		INDOOR UNIT A				
		AUTO	HEAT	DRY	COOL	FAN
INDOOR UNIT B	AUTO	□	□	□	□	□
	HEAT	□	■	□	□	■
	DRY	□	□	■	■	■
	COOL	□	□	■	■	■
	FAN	□	■	■	■	■

■ AVAILABLE
□ NOT AVAILABLE

5-2 Cool Mode Operation

In Cooling Mode, the operation of the compressor (CM), Outdoor Fan (FMO) and Indoor Fan (FMI) are determined by:

- 1) the difference between the room air temperature (RAT) and the set point temperature (SPT)
- 2) the protection level at which the system is operating
- 3) the thermal load in the room

NOTES

In addition to the temperature difference of above, the operation of the main components (CM, FMO, FMI) is also controlled by protection function.

The minimum off time of compressor is 3 minutes.

The indoor fan can change speed only after it has operated at the same speed for 30 sec if in AUTO and 1 sec for the other settings (High, Med, Low).

5-3 Heat Mode Operation

The Heating mode operation is similar to the Cooling mode operation. The CM, FMO and FMI are controlled by the same parameters.

The FMI will not be turned on until the indoor coil temperature is warm enough to prevent the supply of cold air (see COLD DRAFT PREVENTION feature for details).

The indoor fan can change speed only after it has operated at the same speed for 30 sec if in AUTO and 1 sec for the other settings (High, Med, Low).

5-4 Auto Mode Operation (only monosplit)

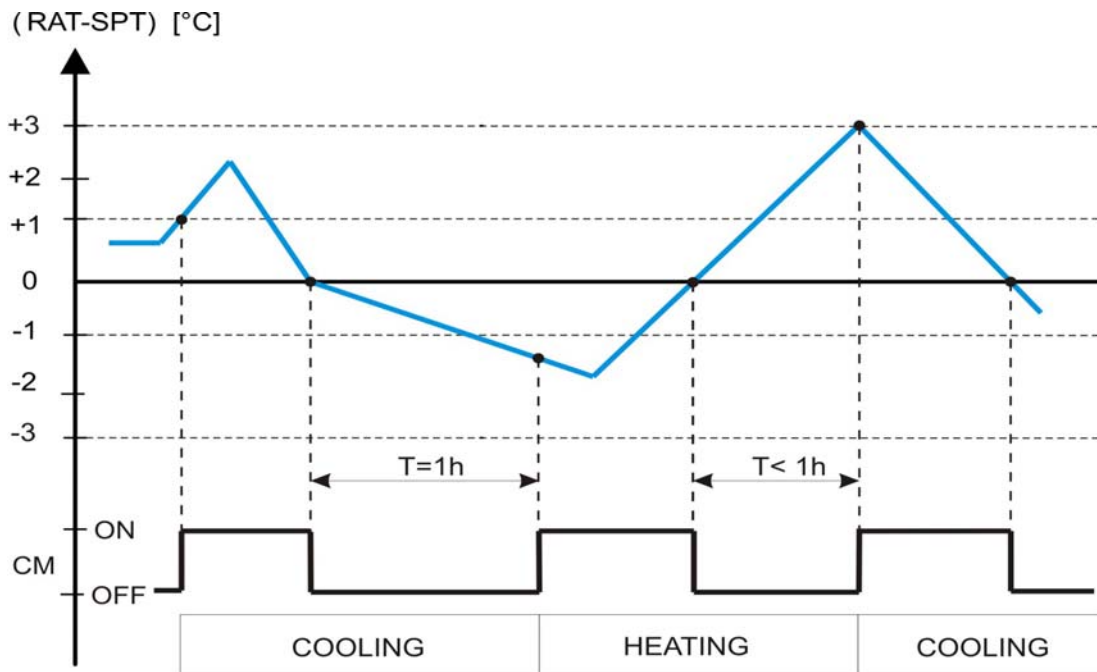

In Auto Mode, the unit switches automatically between the Auto Cooling and Auto Heating in order to maintain the room temperature (RAT) at the prescribed set point (SPT). The switching between the two modes is according to the above graph and following table

COOLING ---> HEATING
If $-3^{\circ}C \leq Dt \leq -1^{\circ}C$ and the compressor is off for more than 1 hour
If $Dt \leq -3^{\circ}C$ and compressor is off for more than 3 minutes

HEATING ---> COOLING
If $1^{\circ}C \leq Dt \leq 3^{\circ}C$ and the compressor is off for more than 1 hour
If $Dt \geq 3^{\circ}C$ and compressor is off for more than 3 minutes

$$Dt = RAT - SPT$$

Refer to the sections 5.1 COOLING MODE and 5.2 HEATING MODE for system operation details.

5-5 Dry Mode Operation

Dry operation remove moisture from indoor air running, in cooling mode, at a low level without reducing the ambient temperature. This is done cycling ON and OFF indoor and outdoor units according to below.

ROOM TEMP	DRY LEVEL	
$\geq \text{SPT}+2^{\circ}\text{C}$	LEVEL 0	Operation according to COOLING mode
$< \text{SPT}+2^{\circ}\text{C}$ $\geq \text{SPT}-1^{\circ}\text{C}$	LEVEL 1	CM on at constant speed FMO on at constant speed FMI switches between L and LL every 30 seconds RV off
$< \text{SPT}-1^{\circ}\text{C}$ $\geq 15^{\circ}\text{C}$	LEVEL 2	CM switches 9 minutes off and 3 minutes on FMO switches 9 minutes off and 3 minutes ON FMI switches between L and LL every 30 seconds RV off
$< 15^{\circ}\text{C}$	DRY OFF ZONE	CM off FMO off FMI off RV off

SPT = Set Point Temperature

5-6 Fan Mode Operation

With this mode, the indoor fan is turned on while CM, FMO and RV stay off all the time. The user can select between 3 speeds: HIGH, MEDIUM and LOW.

5-7 Auto Fan speed

With this option selected, the indoor fan speed changes automatically according to the compressor speed as shown in the following graphs

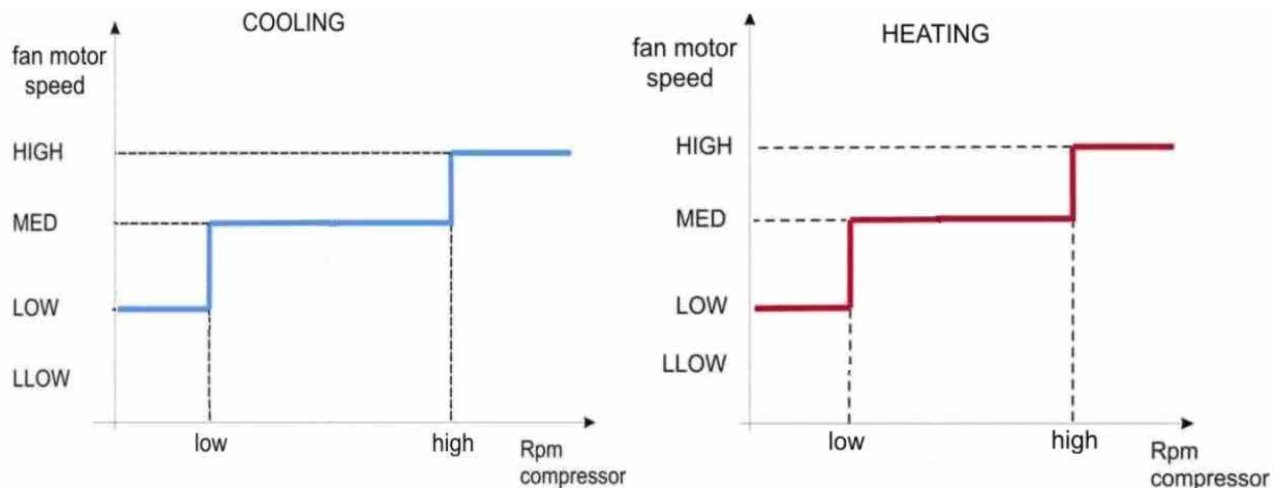

to prevent the supply of cool air, the FMI speed is set as shown only if the indoor coil temperature $\text{ICT} \geq 32^{\circ}\text{C}$ (see COLD DRAFT PREVENTION feature for details)

5-8 Forced Mode

In this mode the system operates (COOLING or HEATING mode – fixed settings) or is switched off by means of the MODE button on the indoor unit control board. The operation modes can be selected pressing the button in a cyclic way (OFF ⇒ COOL ⇒ HEAT ⇒ OFF...). The settings are:

COOLING mode

SET POINT temperature = 25°C
FAN SPEED = HIGH
FLAP POSITION = 3

HEATING mode

SET POINT temperature = 21°C
FAN SPEED = HIGH
FLAP POSITION = 4

5-9 Protection operations indoor unit

5-9.1 Freeze-up

This protection prevents ice formation on the indoor coil heat exchanger. The protection is activated as soon as the indoor coil temperature ICT decreases and acts by decreasing the compressor speed

The system exit this protection routine when ICT temperature rises above 5°C.

5-9.2 Cold draft

This feature prevents the supply of cold air forcing the indoor fan to a speed which cannot be changed by the user.

If the ICT temperature goes down 32°C (in descending) or does not reach 37°C (in rising), the speed fan is set as shown below.

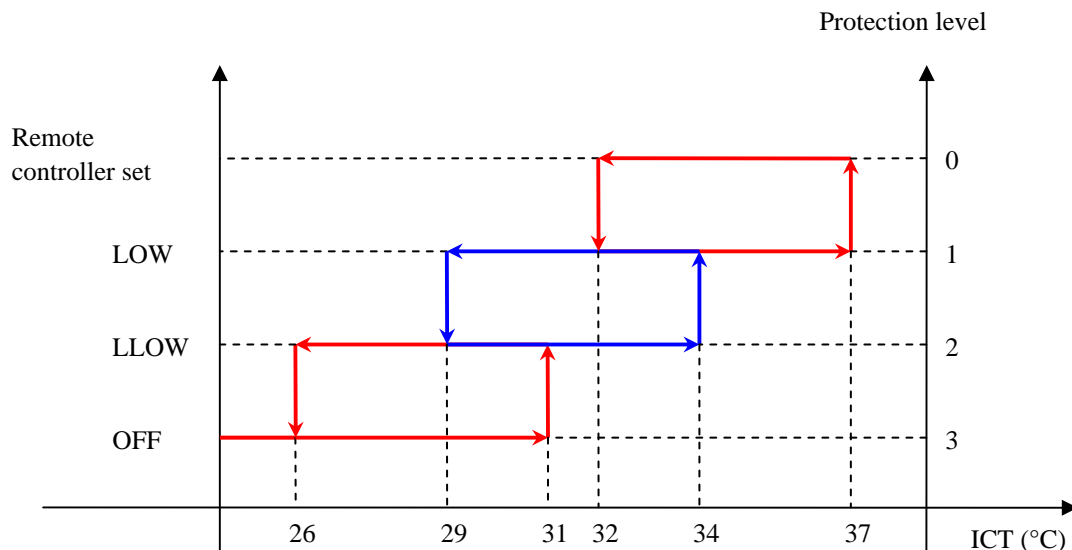

5-9.3 Overheat

This feature prevents the build up of high pressure in the indoor heat exchanger during heating operation. As soon as the indoor coil temperature (ICT) increases, compressor speed is reduced in order to avoid heat exchanger overheating. System stops compressor operation when ICT reaches 60 °C

5-10 Protection operations on outdoor unit

5-10.1 Overheating

During cooling operation as soon as the outdoor coil temperature (OCT) increases, compressor speed is reduced in order to avoid heat exchanger overheating. System stops compressor operation when OCT reaches 60 °C

5-10.2 Compressor discharge temperature

During operation, as soon as the discharge temperature increases, (CDT) compressor speed is reduced in order to avoid overheating of the motor. Compressor is stopped when CDT reaches 110°C

5-10.3 Compressor power-module overheating

The module temperature, detected by a built-in thermistor, is always monitored by the control system and kept operating in a safe area. If temperature exceeds 100°C, operation is automatically stopped.

5-10.4 Outdoor fan power-module overheating

The module temperature, detected by a built-in thermistor, is always monitored by the control system and kept operating in a safe area. If temperature exceeds 100°C, operation is automatically stopped.

5-10.5 Compressor power-module overcurrent

Operation is automatically stopped in case of current driven to each motor phase greater than a value depending on the power of the outdoor unit (9A for 12000btu and 11A for 18000btu)

5-10.6 Outdoor fan power-module overcurrent

In case of current driven to each motor phase greater than 300mA operation is automatically stopped

5-11 Defrost

The defrost process is controlled by a detection algorithm designed in order to maintain optimal utilization of the heat pump capacity especially during negative outdoor temperature conditions.

- Compressor speed fixed
- Expansion valve opening fixed
- Outdoor fan switched off
- Indoor fan controlled by cold draft prevention
- Defrost valve switched on (open)
- Reversing valve switched on (heating operation)

NOTES:

- Minimum defrost time interval is 2 minutes
- During HIGH POWER operation the defrost detection is ignored until this mode remains active
- System exits defrost protection as soon as 14°C on the outdoor coil are detected and, in any case, if at least 12 minutes are elapsed from the start of the defrost cycle.

5-12 I FEEL function

As standard configuration the air conditioner operates detecting the room temperature through the sensor equipped in the wireless remote controller (icon I FEEL shown on the display). This feature provides a personalised environment since the temperature can be detected where the remote controller is located.

It is possible to de-activate this option pressing the I FEEL button on the remote controller.

In this case the I FEEL icon is no longer displayed and room temperature is detected through the sensor included in the indoor unit.

5-13 HI POWER mode

When this mode is active the internal fan speed is set automatically and the air conditioner operates, for 15 minutes, at the maximum power. After 15 minutes from the selection the mode is automatically switched off.

5-14 NIGHT Function

When this setting is active indoor fan speed is automatically reduced in order to allow low noise operation. Temperature control acts in the same way as NORMAL MODE but after 60 minutes of operation the air conditioner modifies automatically the set-point temperature according to the following:

- COOLING/DRY: +1°C
- HEATING: - 2°C

5-15 LED OFF function

This is a special function mode which can be selected by the user pressing, at the same for more than 5 seconds the IFEEL and FAN buttons on the remote controller. With this option active the OPERATION, TIMER and STANDBY lamps are switched off even during operation (they activates only in case of diagnostic signaling).

5-16 Capacity Test mode

This is a special operating mode used when testing the performance of the A/C. In this case the main components of the A/C (compressor , outdoor fan, indoor fan) operate at fixed settings. This option is activated shorting the JP1 and JP3 jumpers on the outdoor pcb and setting the remote controller according to the following:

COOLING MODE: Setpoint = 10°C / I-FEEL OFF
HEATING MODE: Setpoint = 32°C / I-FEEL OFF

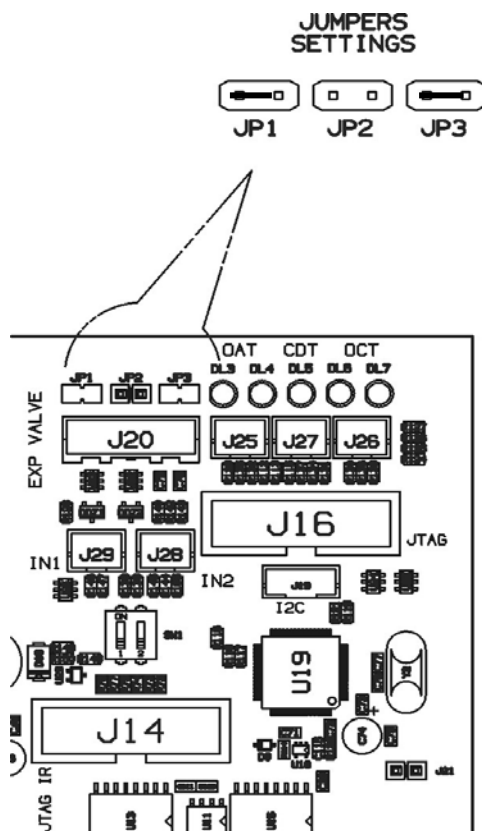

5-17 Diagnostic

With this feature it is possible to have a visual signal that a trouble is occurring.

This mode is always active and the signalling is made through the display board LEDs

In case of no troubles the LEDs status follows its normal function.

The detected troubles are showed to the user/technician using the 3 leds of the indoor unit receive and the 5 leds on the outdoor pcb. For each fault there are different effects upon the operation of the A/C:

NOTES

- The troubles are showed according to a priority list that is, in case of more than one trouble present, is always showed, at first, the one with the highest priority (1 ⇔ 2 ⇔ 3 etc).
- Sensor damaged means a situation where sensor is short-circuited or opened
- In case of damaged sensors, the system (CM, FMO, FMI etc), if in OFF state, does not start

Priority	INDOOR UNIT FAULT	LEDS status			Effects
		LD2(opr)	LD1(stby)	LD3(timer)	
4	RAT probe damaged	F	F	O	System does not operate. To restart the system, power re-setting (off-on) is required
3	ICT probe damaged	F	O	F	
2	communication error	F	F	F	The A/C switches off. As soon as fault is cleared the system automatically restart
1	fault on outdoor unit	O	F	O	
0	wrong mode selected	●	F	F	system does not operate. To restart the system, select correct mode

O = LED off

F = LED blinking

● = LED on

5-18 Indoor Unit Jumpers Configuration

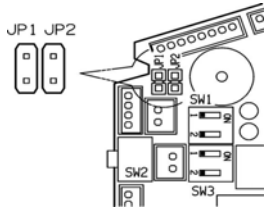

Unit is shipped with jumpers set according to the following table:

JUMPER	STATUS
JP1	open
JP2	open

5-19 Outdoor Unit Jumpers Configuration

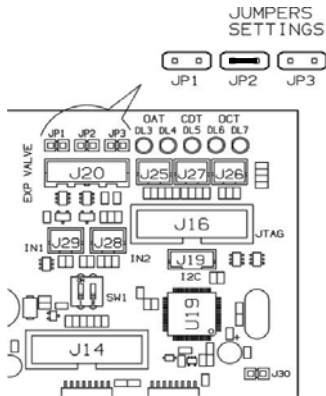

Unit is shipped with jumpers set according to the following table:

JUMPER	STATUS
JP1	open
JP2	closed
JP3	open

5-20 Contacts for Building Automation

5-20.1 Input Contact (J11 - green)

The status of this input affects system operation according to the following:

Contact OPEN : system does not operate (always OFF) – inputs from wireless remote controller are not processed

Contact CLOSED: system operates in the normal way according to the inputs coming from wireless remote controller

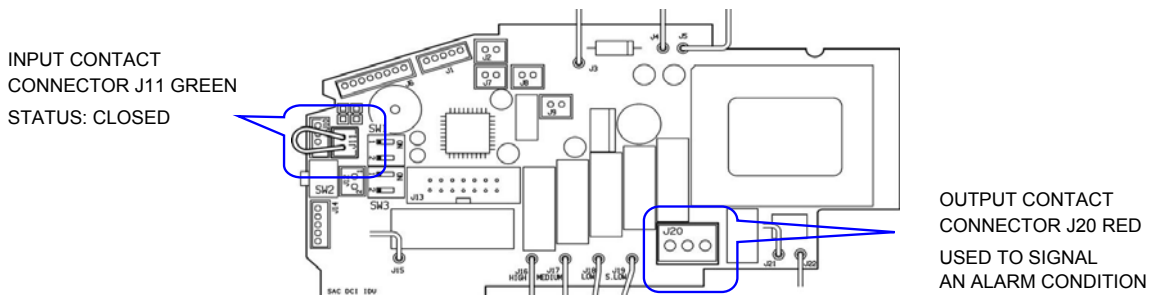

5-20.2 Output Contact (J20 - red)

This connector is directly tied to the contact (normally open) of a power relay which activates every time the following alarm condition occur:

- RAT damaged
- ICT damaged
- Communication error
- Fault on outdoor unit

In this case when alarm happens, on poles 1 and 3 of J20 connector, 220 VAC-50Hz are available.
Max electrical load: **1A- 240VAC**

6. INDOOR UNIT AND REMOTE CONTROL ADDRESS

6-1 Address Switches (only for multisplit)

INDOOR UNIT A

Check that the setting of switches SW1 and SW3 (on the pcb) and dip switch of remote control correspond to the figure:

indoor unit PCB

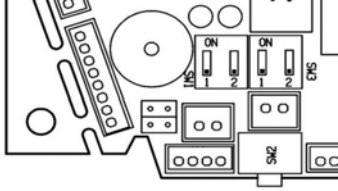

SW1 SW3
1= off 1= off
2= off 2= off
(PCB factory state)

remote control unit

(dip switch is located on the battery compartment)

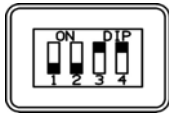

1= off
2= off
3= on
4= on
(remote control factory state)

INDOOR UNIT B

Set the switches SW1 and SW3 (on the pcb) and dip switch of remote control as shown in the figure:

indoor unit PCB

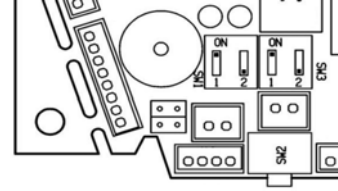

SW1 SW3
1= on 1= on
2= off 2= off

remote control unit

(dip switch is located on the battery compartment)

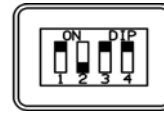

1= on
2= off
3= on
4= on

6-2 Refrigerant Circuit Check (only for multisplit)

- Power ON the system
- Set the remote controller of the unit A as following (unit B must be OFF):
mode: **COOLING**
filter: **ON**
set point: **32°C**
- Press FAN + IFEEL button for at least 5 seconds, pointing the remote control unit directly at the air conditioner receiver
System starts and runs for 3 minutes
After 3 minutes operation:
in case the setting is right: the unit switches to COOL mode and stops (set point 32°C)
the system is ready to operate
in case the setting is wrong: the STANDBY lamp flashes
check the setting of indoor units and the connections of the refrigerant circuits

6-3 Changing the Address of the Air Conditioner

In case of more than one air conditioner operating in the same room, it may be necessary to assign an address to each unit in order to avoid operation conflicts. Address is set acting on the dip-switches located on the indoor PCB and on the remote controller. The PCB settings must match the corresponding ones on the wireless remote controller.

How to change address of the air conditioner

Set the PCB and the remote control to the address desired

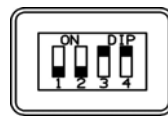
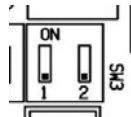

UNIT ADDRESS	SW3 (PCB)		DIP SWITCH (REMOCON)				
	1	2	1	2	3	4	
1	off	off	off	off	on	on	unit A
2	on	off	on	off	on	on	unit B
3	off	on	off	on	on	on	available
4	on	on	on	on	on	on	available

For monosplit all combinations are available

7) TROUBLESHOOTING

7-1 CHECK BEFORE AND AFTER «TROUBLESHOOTING»

(A) Check power supply wiring.

- Check the power supply wires are correctly connected.

(B) Check power supply.

- Check that voltage is in specified range ($\pm 10\%$ of the rating).
- Check that power is being supplied.

• **WARNING: If the following troubleshooting must be done with power supplied, be careful not to touch any uninsulated live part that can cause *electric shock***

7-2 CIRCUIT BREAKER TRIPS OR FUSE BLOWS.

- When circuit breaker is set to ON, it trips in a few moments. Resetting is not possible.
- Measure insulation resistance. There is a possibility of ground fault.
If resistance value is 1 Mohm or less, insulation is defective.

7-3 SYSTEM DOES NOT RUN.

1 - THERE IS NO SIGNALING LED ON INDOOR UNIT

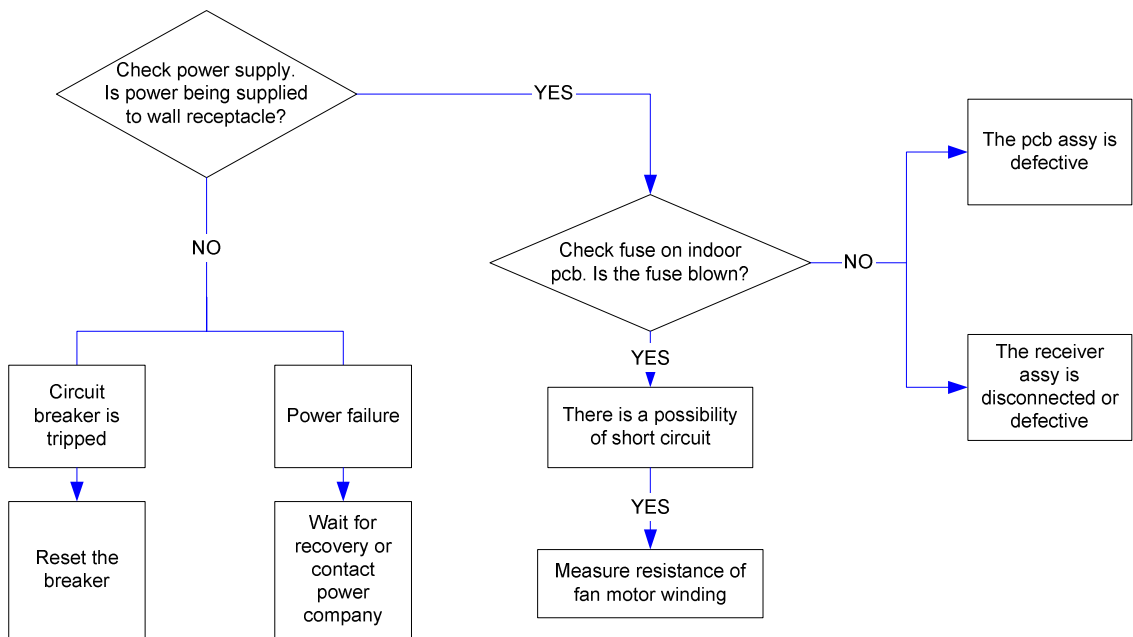

2 - IN INDOOR UNIT THERE IS ONE LED ON AT LEAST AND THE UNIT RECEIVES THE REMOTE CONTROL SIGNAL

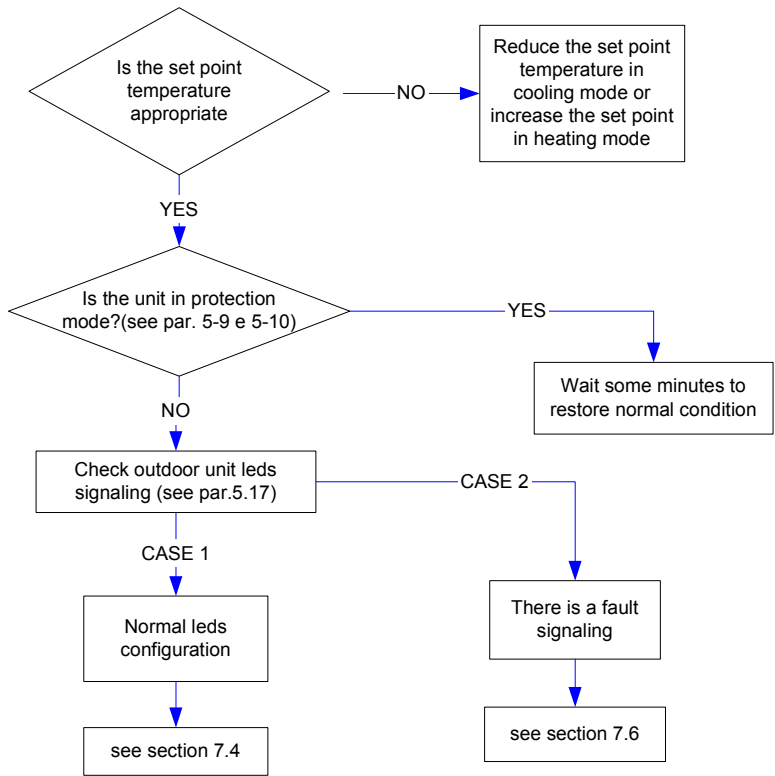

7-3 SYSTEM DOES NOT RUN.

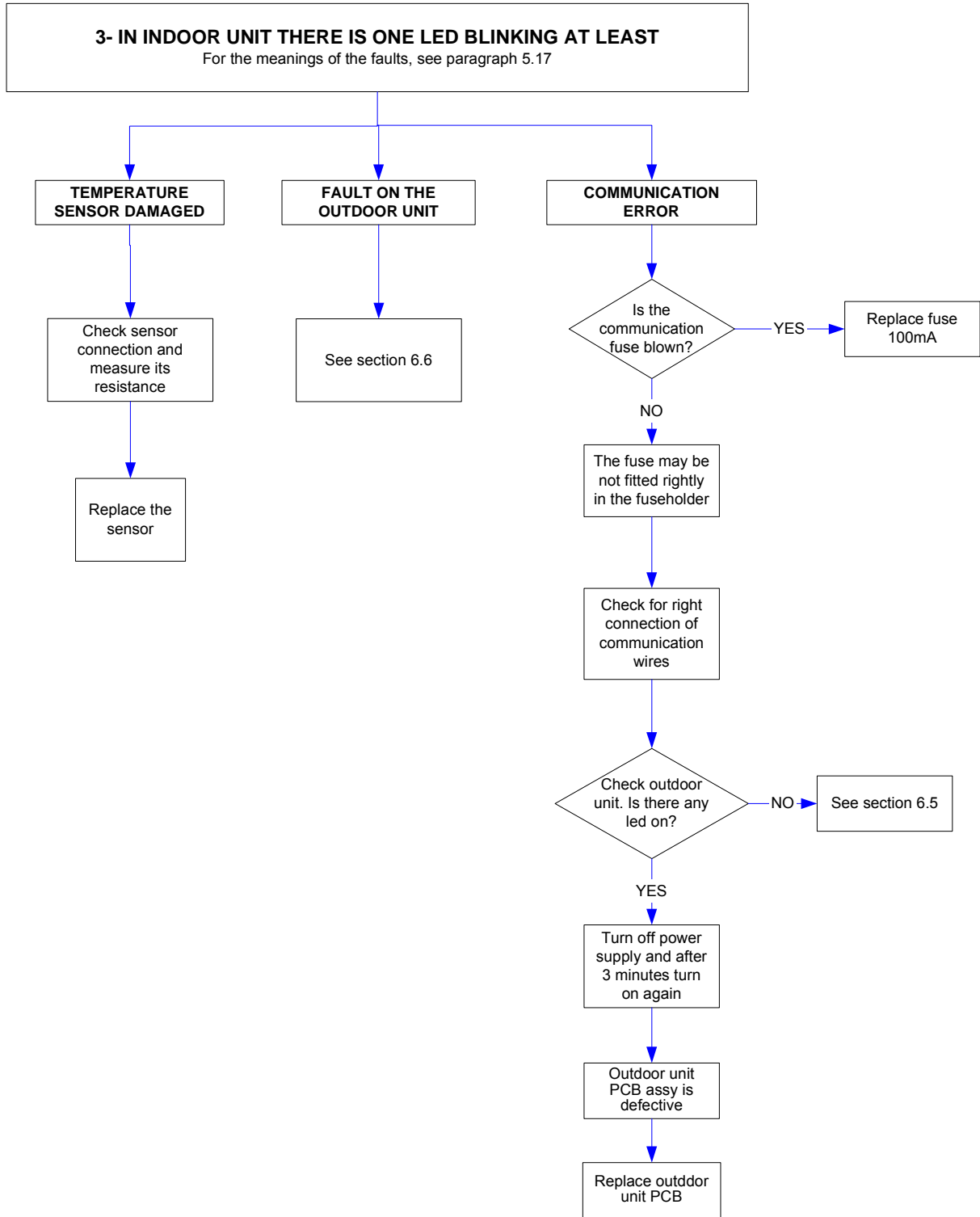

7-4 OUTDOOR UNIT DOES NOT RUN AND NO FAULT IS DISPLAYED

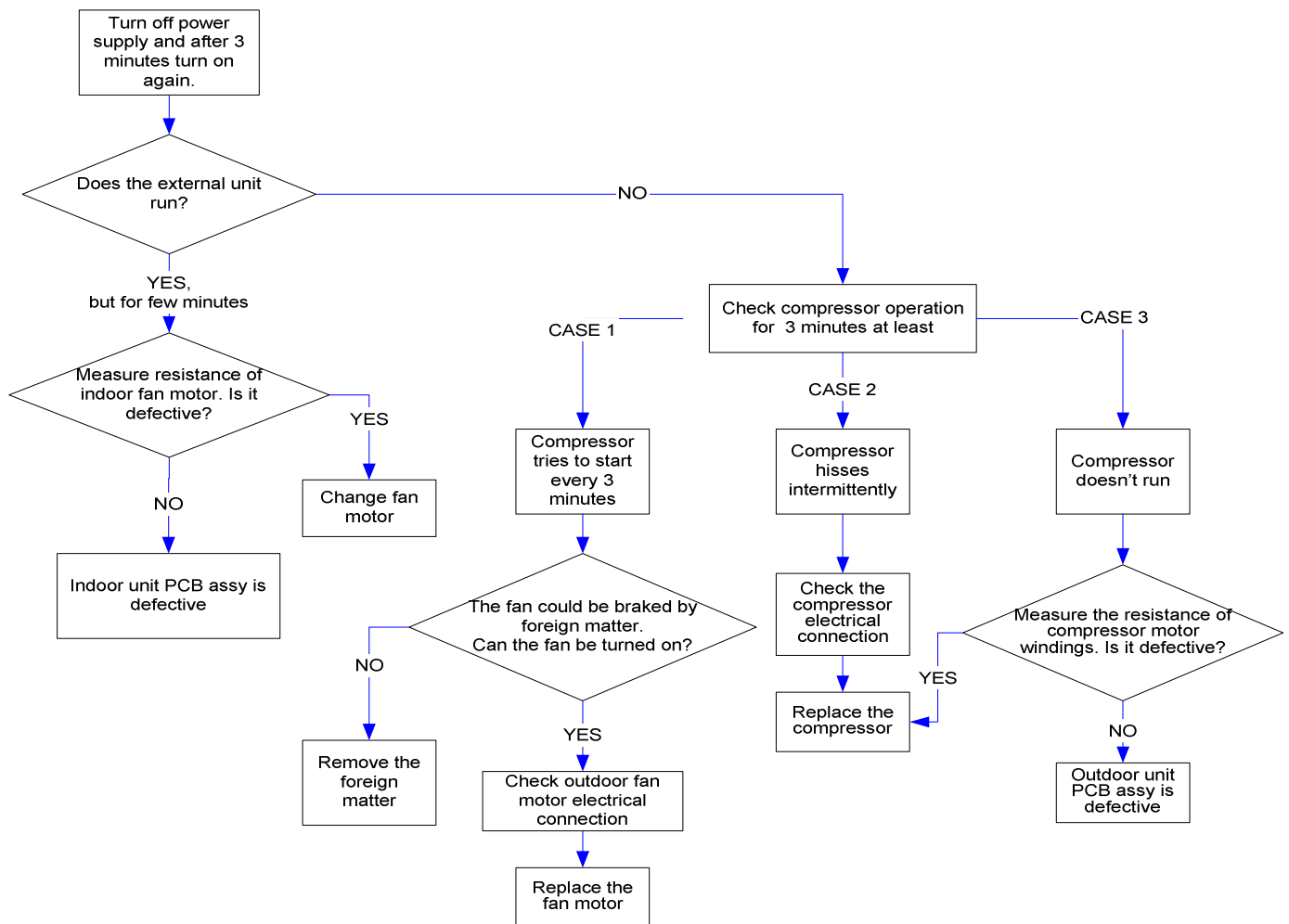

7-5 ONLY OUTDOOR UNIT IS OFF

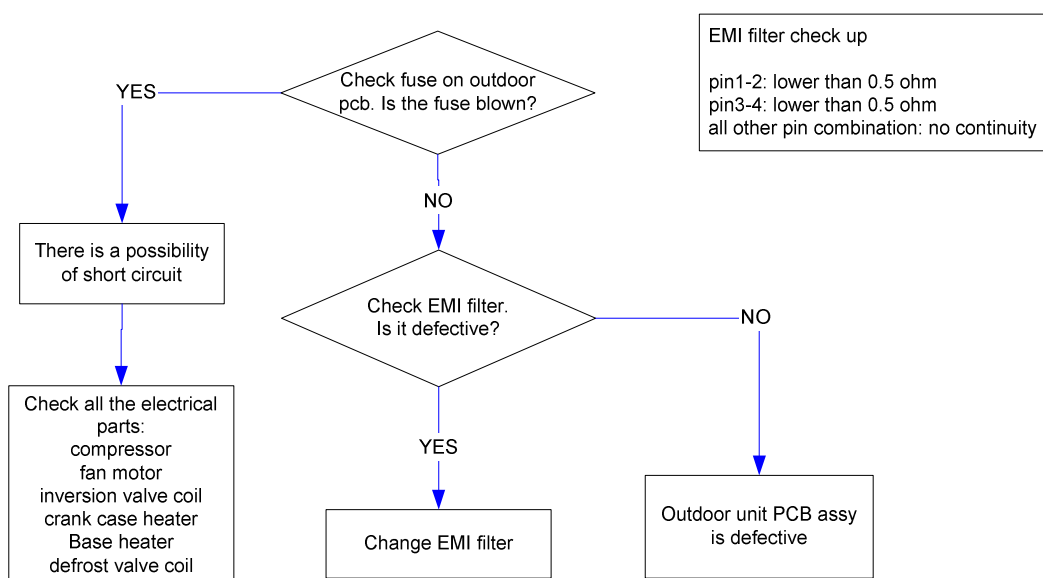

7-6 FAULT ON OUTDOOR UNIT

IN OUTDOOR UNIT THERE IS ONE LED BLINKING AT LEAST

For the meanings of the faults, see paragraph 5.17

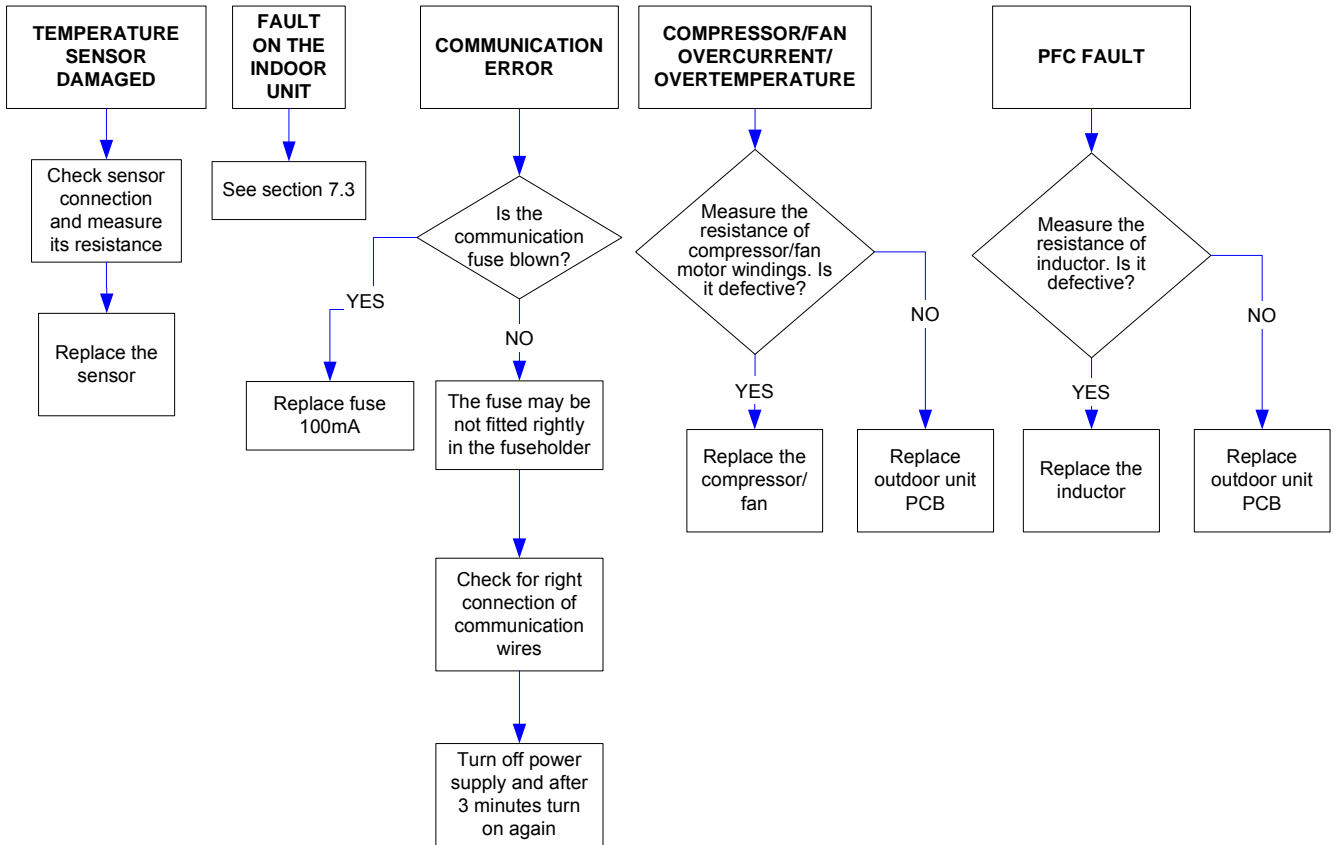

7-7 AIR CONDITIONER OPERATES, BUT ABNORMALITIES ARE OBSERVED.

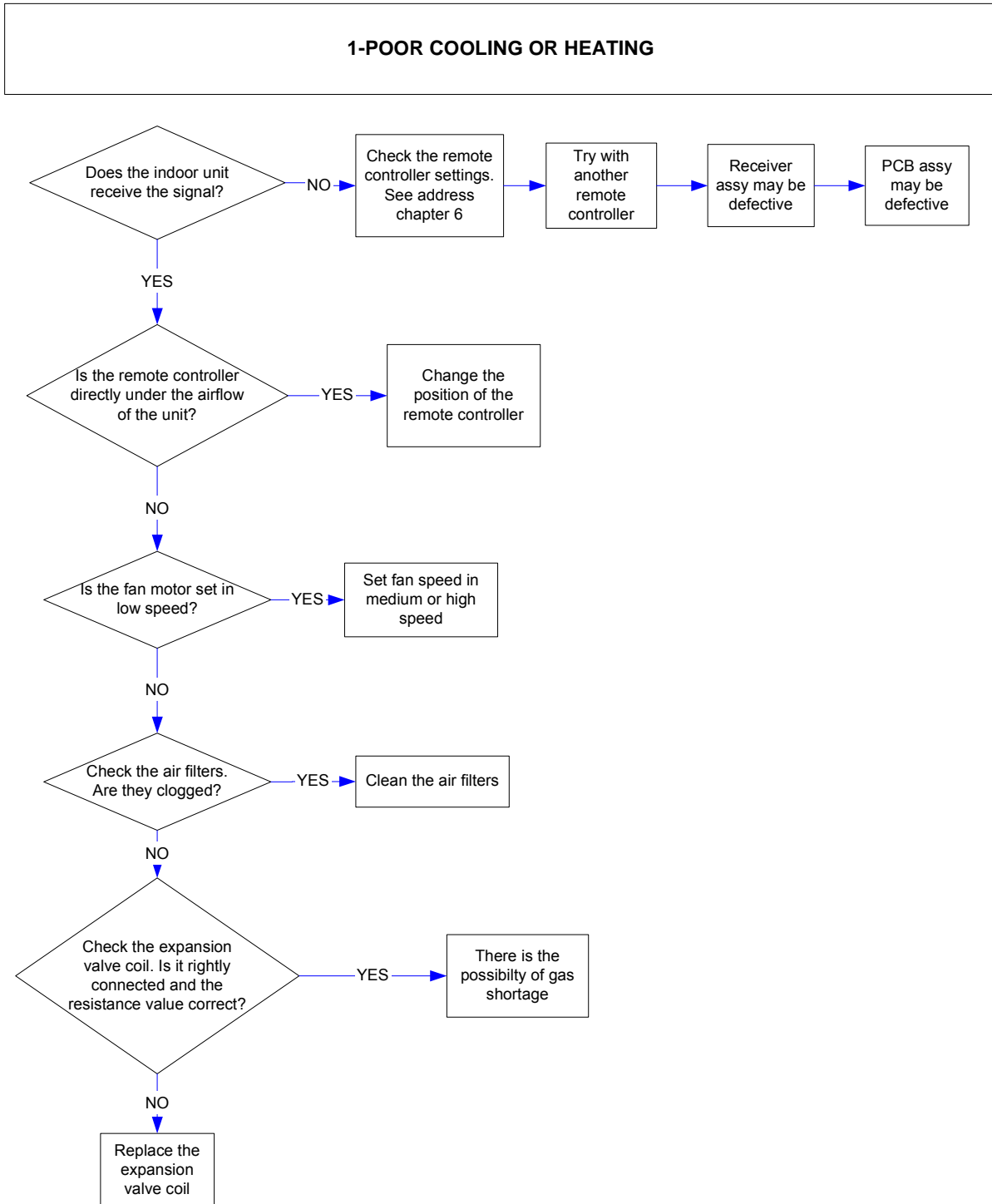

7-7 AIR CONDITIONER OPERATES, BUT ABNORMALITIES ARE OBSERVED.

2 - OPERATION DOES NOT SWITCH FROM HEAT TO COOL AND FROM COOL TO HEAT

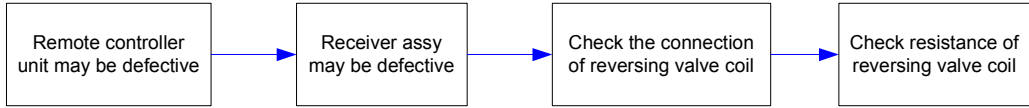

3 - CHECK "MODE BUTTON" OPERATION ON THE UNIT

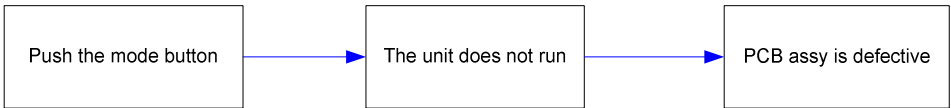

4 - CHECK REMOTE CONTROLLER UNIT

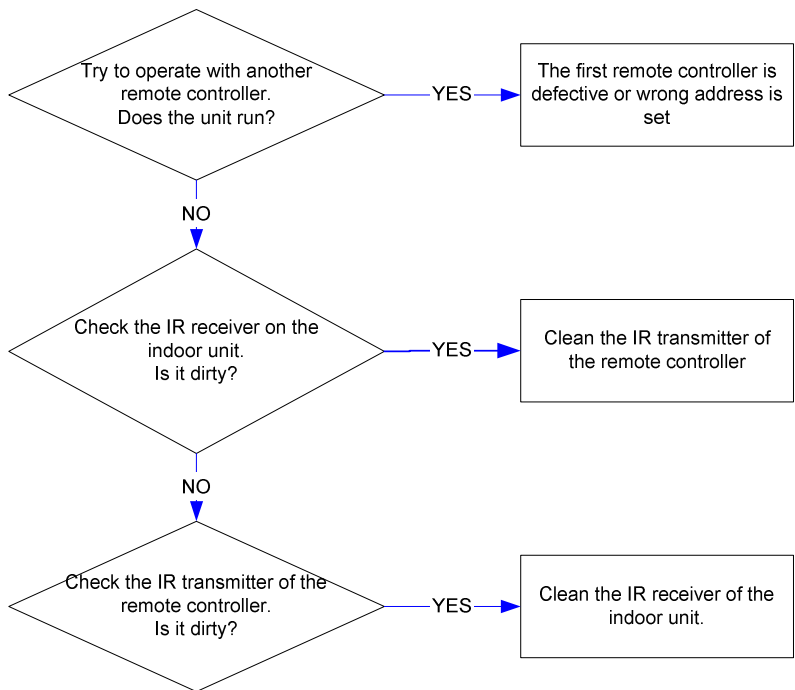

7-8 NOISE PROBLEM

OUTDOOR UNIT TOO NOISY

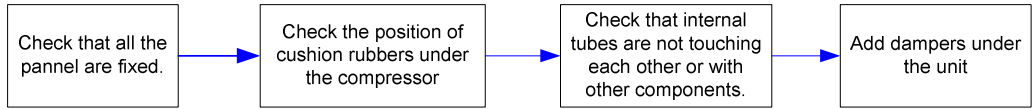

8. CHECKING ELETRICAL COMPONENTS

8-1 Measurement of Insulation Resistance

The insulation is in good condition if the resistance exceeds 1 Mohm

a) Power Supply Wires

Clamp the earthed wire of the power supply wires with the lead clip of the insulation resistance tester and measure the resistance by placing a probe on either of the power wires (fig.1).

Then measure the resistance between the earthed wire and the other power wires (fig.1).

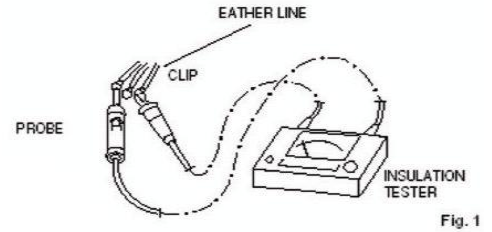

Fig. 1

b) Unit

Clamp an alluminium plate fin or copper tube with the lead clip of the insulation resistance tester and measure the resistance by placing a probe on N terminal, and then on Lterminal the terminal plate (fig.2)

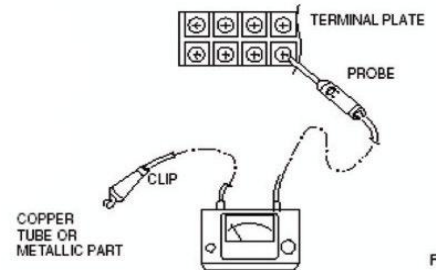

Fig. 2

c) Measurement of Insulation Resistance for Electrical Parts

Disconnect the lead wires of the disired electric part from terminal plate, PCB assy, capacitor, etc.

Similary disconnect the connector. Then measure the insulation resistance (fig.1 to 4). Refer to electric wiring diagram.

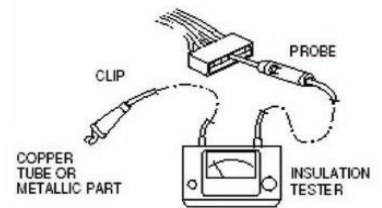

Fig. 3

NOTE

If the probe cannot enter the poles because the hole is too narrow then use a probe with a thinner pin.

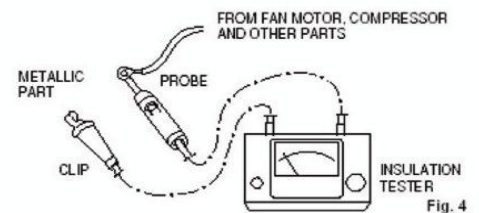

Fig. 4

8-2 Checking Continuity of fuse on PCB assy

Remove PCB assy from electrical component box (fig.5)

Then pull out the fuse from PCB assy

Check continuity of fuse by the multimeter (fig.6)

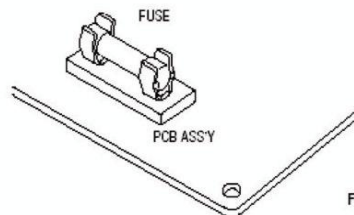

Fig. 5

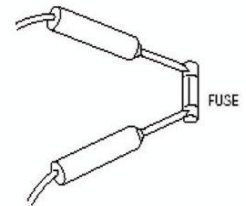

Fig. 6

8-3 Checking Motor Capacitor

Remove the lead wires from the capacitor terminals, and then place a probe on the capacitor terminals as shown in fig.7.

Observe the deflection of the pointer, setting the resistance measuring range of the multimeter to the maximum value.

The capacitor is "good" if the pointer bounces to a great extent and the gradually returns to its original position.

The range of deflection and deflection time deffer according to capacity of the capacitor.

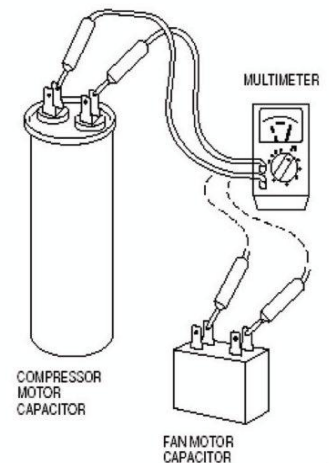

Fig. 7

argoclima s.p.a.

Via Varese, 90 - 21013 Gallarate - Va - Italy
Tel. +39 0331 755111 - Fax +39 0331 776240
www.argoclima.com